

## Features

- Closed loop multi-range current transducer
- Voltage output
- Unipolar supply voltage
- Compact design for PCB mounting.

## Special Feature

- Primary conductors with  $2 \times 2$  turns (differential measurement).

## Advantages

- Very low offset drift
- Very good  $dv/dt$  immunity
- CASR footprint compatible
- Reference pin with two modes: Ref IN and Ref OUT
- Extended measuring range for unipolar measurement.

## Applications

- AC variable speed and servo motor drives
- Static converters for DC motor drives
- Battery supplied applications
- Uninterruptible Power Supplies (UPS)
- Switched Mode Power Supplies (SMPS)
- Power supplies for welding applications
- Solar inverters.

## Standards

- IEC 61800-1: 1997
- IEC 61800-2: 2015
- IEC 61800-3: 2004
- IEC 61800-5-1: 2007
- IEC 62109-1: 2010
- IEC 62477-1: 2012
- UL 508:2013.

## Application Domain

- Industrial.

## Absolute maximum ratings

Parameter	Symbol	Unit	Value
Maximum supply voltage	$U_{C \max}$	V	7
Maximum primary conductor temperature	$T_{B \max}$	°C	110
Maximum primary current	$I_{P \max}$	A	$20 \times I_{PN}$
Maximum electrostatic discharge voltage	$U_{ESD \max}$	kV	4

Stresses above these ratings may cause permanent damage. Exposure to absolute maximum ratings for extended periods may degrade reliability.

## UL 508: Ratings and assumptions of certification

File # E189713 Volume: 2 Section: 11

### Standards

- CSA C22.2 NO. 14-10 INDUSTRIAL CONTROL EQUIPMENT - Date 2011/08/01
- UL 508 STANDARD FOR INDUSTRIAL CONTROL EQUIPMENT - Date 2013

### Ratings

Parameter	Symbol	Unit	Value
Primary involved potential		V AC/DC	600
Max surrounding air temperature	$T_A$	°C	105
Primary current	$I_P$	A	According to series primary currents
Secondary supply voltage	$U_C$	V DC	7
Output voltage	$V_{out}$	V	0 to 5

### Conditions of acceptability

When installed in the end-use equipment, consideration shall be given to the following:

- 1 - These devices must be mounted in a suitable end-use enclosure.
- 2 - The terminals have not been evaluated for field wiring.
- 3 - The LES, LESR, LKSR, LPSR, LXS and LXSR Series shall be used in a pollution degree 2 environment or better.
- 4 - Low voltage circuits are intended to be powered by a circuit derived from an isolating source (such as a transformer, optical isolator, limiting impedance or electro-mechanical relay) and having no direct connection back to the primary circuit (other than through the grounding means).
- 5 - These devices are intended to be mounted on the printed wiring board of the end-use equipment (with a minimum CTI of 100).
- 6 - LES, LESR, LKSR and LPSR Series: based on results of temperature tests, in the end-use application, a maximum of 110°C cannot be exceeded on the primary jumper.

### Marking

Only those products bearing the UL or UR Mark should be considered to be Listed or Recognized and covered under UL's Follow-Up Service. Always look for the Mark on the product.

**Insulation coordination**

Parameter	Symbol	Unit	Value	Comment
RMS voltage for AC insulation test, 50 Hz, 1 min	$U_d$	kV	4.3	
Impulse withstand voltage 1.2/50 $\mu$ s	$\hat{U}_w$	kV	8	
Insulation resistance	$R_{INS}$	G $\Omega$	18	measured at 500 V DC
Partial discharge RMS test voltage ( $q_m < 10$ pC)	$U_t$	kV	1.65	
Clearance (pri. - sec.)	$d_{Cl}$	mm		See dimensions drawing on page 14
Creepage distance (pri. - sec.)	$d_{Cp}$			
Case material	-	-	V0	According to UL 94
Comparative tracking index	$CTI$		600	
Application example		V	300	Reinforced insulation, non uniform field according to IEC 61800-5-1, CAT III, PD2
Application example		V	600	Basic insulation, non uniform field according to IEC 61800-5-1, CAT III, PD2

**Environmental and mechanical characteristics**

Parameter	Symbol	Unit	Min	Typ	Max	Comment
Ambient operating temperature	$T_A$	$^{\circ}$ C	-40		105	
Ambient storage temperature	$T_s$	$^{\circ}$ C	-55		125	
Mass	$m$	g		10		

**Electrical data LESR 25-NP/SP1**

At  $T_A = 25\text{ °C}$ ,  $U_C = +5\text{ V}$ ,  $N_P = 1\text{ turn}$ ,  $R_L = 10\text{ k}\Omega$  internal reference, unless otherwise noted (see Definition of typical, minimum and maximum values paragraph in page 13).

Parameter	Symbol	Unit	Min	Typ	Max	Comment
Primary nominal RMS current	$I_{PN}$	A		25		Apply derating according to fig. 11
Primary current, measuring range	$I_{PM}$	A	-85		85	
Number of primary turns	$N_P$			1, 2		
Supply voltage	$U_C$	V	4.75	5	5.25	
Current consumption	$I_C$	mA		$18 + \frac{I_p(\text{mA})}{N_s}$	$20.5 + \frac{I_p(\text{mA})}{N_s}$	$N_s = 2000\text{ turns}$
Reference voltage @ $I_P = 0\text{ A}$	$V_{ref}$	V	2.485	2.5	2.515	Internal reference
External reference voltage	$V_{ref}$	V	0.5		2.75	
Output voltage	$V_{out}$	V	0.25		4.75	with $U_C = +5\text{ V}$
Output voltage @ $I_P = 0\text{ A}$	$V_{out}$	V		$V_{ref}$		
Electrical offset voltage	$V_{OE}$	mV	-1.5		1.5	100 % tested $V_{out} - V_{ref}$
Electrical offset current referred to primary	$I_{OE}$	mA	-60		60	100 % tested
Temperature coefficient of $V_{ref}$ @ $I_P = 0\text{ A}$	$TCV_{ref}$	ppm/K			$\pm 70$	Internal reference
Temperature coefficient of $V_{out}$ @ $I_P = 0\text{ A}$	$TCV_{out}$	ppm/K			$\pm 4$	ppm/K of 2.5 V -40 °C ... 105 °C
Theoretical sensitivity	$G_{th}$	mV/A		25		$625\text{ mV}/I_{PN}$
Sensitivity error	$\epsilon_G$	%	-0.6		0.6	100 % tested
Temperature coefficient of $G$	$TCG$	ppm/K			$\pm 50$	-40 °C ... 105 °C
Linearity error	$\epsilon_L$	% of $I_{PN}$	-0.1		0.1	
Magnetic offset current ( $10 \times I_{PN}$ ) referred to primary	$I_{OM}$	mA	-80		80	
Output RMS noise voltage spectral density 100 ... 100 kHz referred to primary	$e_{no}$	$\mu\text{V}/\text{Hz}^{1/2}$		1.8		
Output noise voltage DC ... 10 kHz DC ... 100 kHz DC ... 1 MHz	$V_{no}$	mVpp		2.6 3.9 5.1		
Reaction time @ 10 % of $I_{PN}^{1)}$	$t_{ra}$	$\mu\text{s}$			0.3	$R_L = 1\text{ k}\Omega$ , $di/dt = 50\text{ A}/\mu\text{s}$
Step response time to 90 % of $I_{PN}^{1)}$	$t_r$	$\mu\text{s}$			0.4	$R_L = 1\text{ k}\Omega$ , $di/dt = 50\text{ A}/\mu\text{s}$
Frequency bandwidth ( $\pm 3\text{ dB}$ )	$BW$	kHz	300			$R_L = 1\text{ k}\Omega$
Overall accuracy	$X_G$	% of $I_{PN}$			0.9	
Overall accuracy @ $T_A = 85\text{ °C}$ (105 °C)	$X_G$	% of $I_{PN}$			1.15 (1.25)	
Accuracy	$X$	% of $I_{PN}$			0.7	
Accuracy @ $T_A = 85\text{ °C}$ (105 °C)	$X$	% of $I_{PN}$			1 (1.1)	

Note: <sup>1)</sup>Differential primary current applied to pin 4, 5, 6, 7.

**Electrical data LESR 50-NP/SP1**

At  $T_A = 25\text{ °C}$ ,  $U_C = +5\text{ V}$ ,  $N_P = 1\text{ turn}$ ,  $R_L = 10\text{ k}\Omega$  internal reference, unless otherwise noted (see Definition of typical, minimum and maximum values paragraph in page 13).

Parameter	Symbol	Unit	Min	Typ	Max	Comment
Primary nominal RMS current	$I_{PN}$	A		50		Apply derating according to fig. 12
Primary current, measuring range	$I_{PM}$	A	-150		150	
Number of primary turns	$N_P$			1, 2		
Supply voltage	$U_C$	V	4.75	5	5.25	
Current consumption	$I_C$	mA		$18 + \frac{I_p(\text{mA})}{N_s}$	$20.5 + \frac{I_p(\text{mA})}{N_s}$	$N_s = 1600\text{ turns}$
Reference voltage @ $I_P = 0\text{ A}$	$V_{ref}$	V	2.485	2.5	2.515	Internal reference
External reference voltage	$V_{ref}$	V	0.5		2.75	
Output voltage	$V_{out}$	V	0.25		4.75	with $U_C = +5\text{ V}$
Output voltage @ $I_P = 0\text{ A}$	$V_{out}$	V		$V_{ref}$		
Electrical offset voltage	$V_{OE}$	mV	-0.875		0.875	100 % tested $V_{out} - V_{ref}$
Electrical offset current referred to primary	$I_{OE}$	mA	-70		70	100 % tested
Temperature coefficient of $V_{ref}$ @ $I_P = 0\text{ A}$	$TCV_{ref}$	ppm/K			$\pm 70$	Internal reference
Temperature coefficient of $V_{out}$ @ $I_P = 0\text{ A}$	$TCV_{out}$	ppm/K			$\pm 3$	ppm/K of 2.5 V -40 °C ... 105 °C
Theoretical sensitivity	$G_{th}$	mV/A		12.5		$625\text{ mV}/I_{PN}$
Sensitivity error	$\varepsilon_G$	%	-0.6		0.6	100 % tested
Temperature coefficient of $G$	$TCG$	ppm/K			$\pm 50$	-40 °C ... 105 °C
Linearity error	$\varepsilon_L$	% of $I_{PN}$	-0.1		0.1	
Magnetic offset current ( $10 \times I_{PN}$ ) referred to primary	$I_{OM}$	mA	-80		80	
Output RMS noise voltage spectral density 100 ... 100 kHz referred to primary	$e_{no}$	$\mu\text{V}/\text{Hz}^{1/2}$		1.7		
Output noise voltage DC ... 10 kHz DC ... 100 kHz DC ... 1 MHz	$V_{no}$	mVpp		2.4 3.2 4.8		
Reaction time @ 10 % of $I_{PN}$ <sup>1)</sup>	$t_{ra}$	$\mu\text{s}$			0.3	$R_L = 1\text{ k}\Omega$ , $di/dt = 50\text{ A}/\mu\text{s}$
Step response time to 90 % of $I_{PN}$ <sup>1)</sup>	$t_r$	$\mu\text{s}$			0.4	$R_L = 1\text{ k}\Omega$ , $di/dt = 50\text{ A}/\mu\text{s}$
Frequency bandwidth ( $\pm 3\text{ dB}$ )	$BW$	kHz	300			$R_L = 1\text{ k}\Omega$
Overall accuracy	$X_G$	% of $I_{PN}$			0.8	
Overall accuracy @ $T_A = 85\text{ °C}$ (105 °C)	$X_G$	% of $I_{PN}$			1.05 (1.15)	
Accuracy	$X$	% of $I_{PN}$			0.7	
Accuracy @ $T_A = 85\text{ °C}$ (105 °C)	$X$	% of $I_{PN}$			0.95 (1.05)	

Note: <sup>1)</sup>Differential primary current applied to pin 4, 5, 6, 7.

Typical performance characteristics LESR 25-NP/SP1

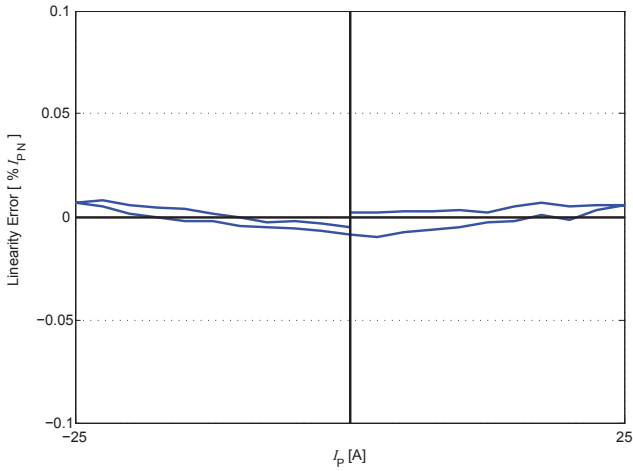

Figure 1: Linearity error

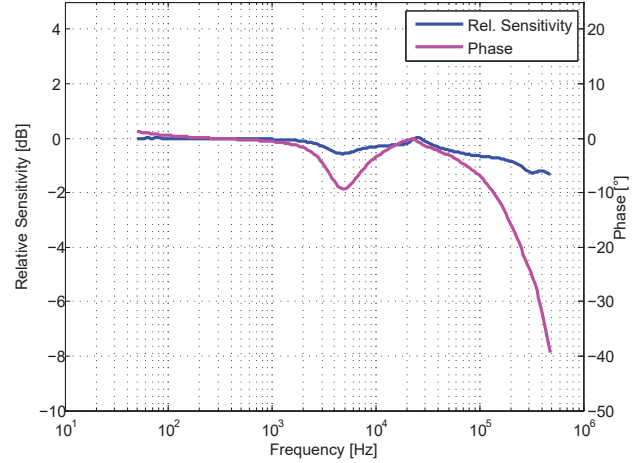

Figure 2: Frequency response

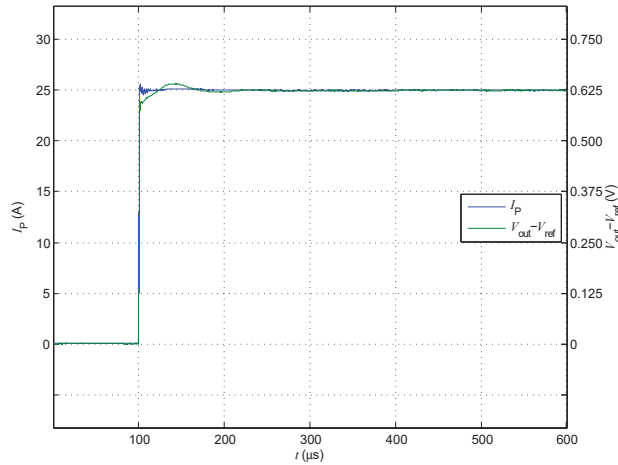

Figure 3: Step response

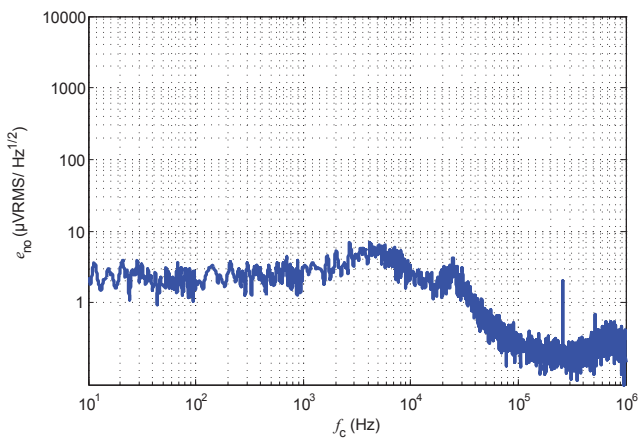

Figure 4: Output noise voltage spectral density

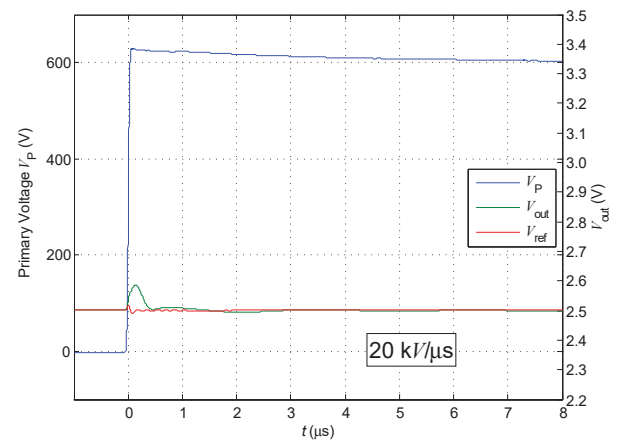

Figure 5: dv/dt

Typical performance characteristics LESR 50-NP/SP1

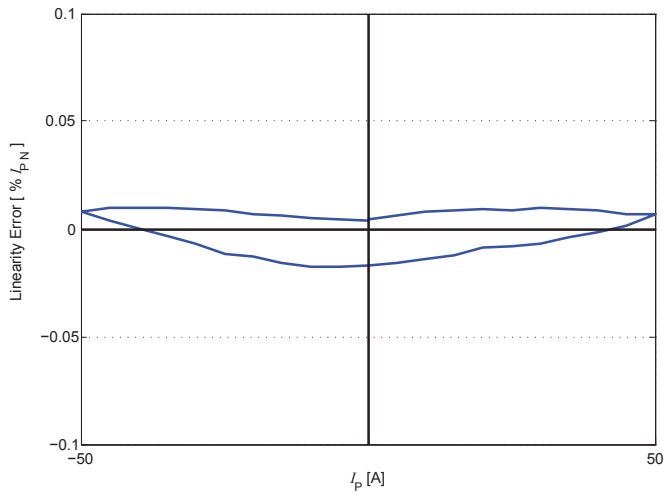

Figure 6: Linearity error

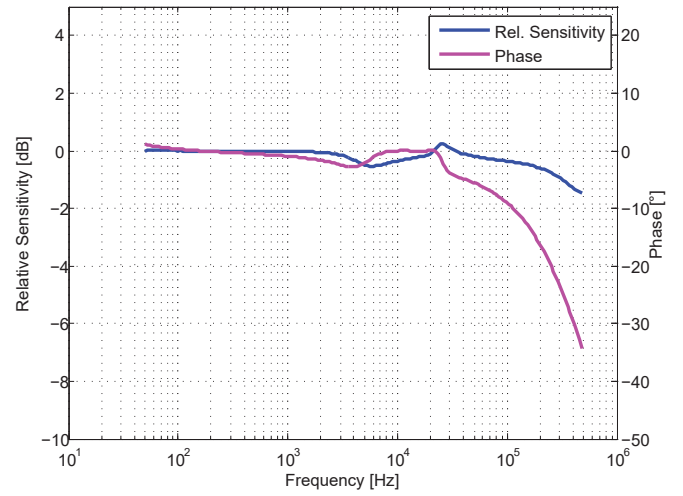

Figure 7: Frequency response

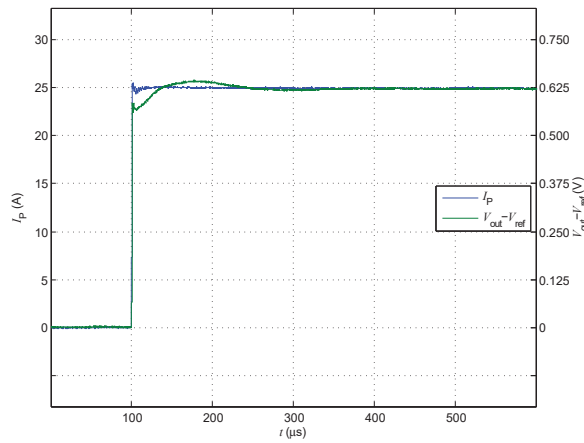

Figure 8: Step response

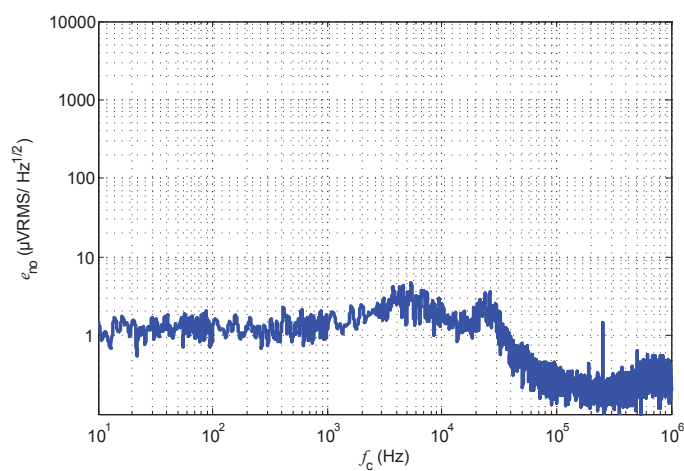

Figure 9: Output noise voltage spectral density

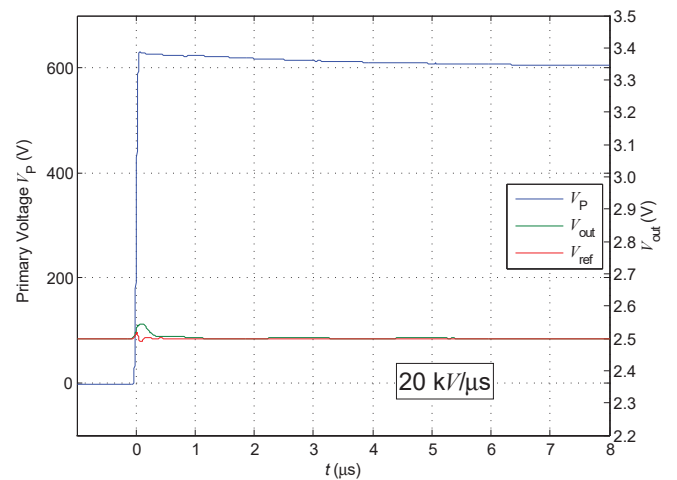

Figure 10:  $dv/dt$

### Maximum continuous DC primary current

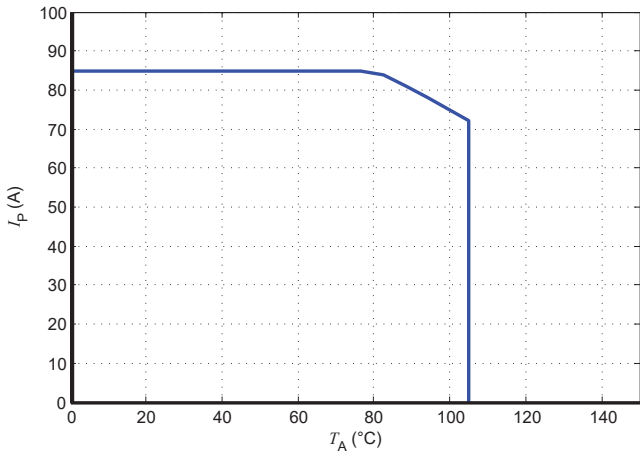

Figure 11:  $I_p$  vs  $T_A$  for LESR 25-NP/SP1

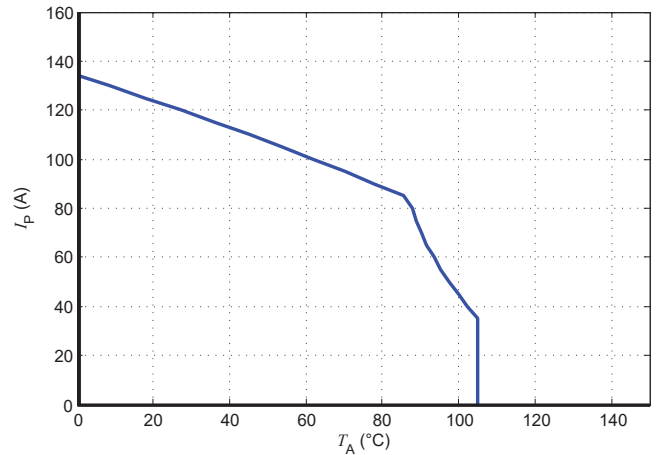

Figure 12:  $I_p$  vs  $T_A$  for LESR 50-NP/SP1

The maximum continuous DC primary current plot shows the boundary of the area for which all the following conditions are true:

- $I_p < I_{pM}$
- Junction temperature  $T_j < 125$  °C
- Primary conductor temperature  $< 110$  °C
- Max power dissipation of internal resistors  $< 0.5 \times$  resistors nominal power

### Frequency derating

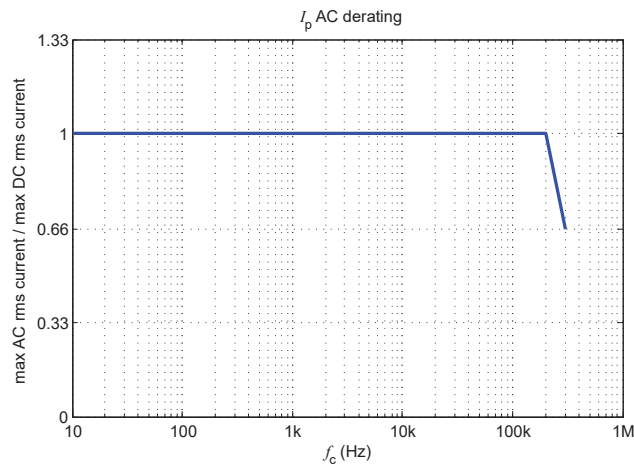

Figure 13: Maximum RMS AC primary current / maximum DC primary current vs frequency



## Performance parameters definition

### Ampere-turns and amperes

The transducer is sensitive to the primary current linkage  $\theta_p$  (also called ampere-turns).

$$\theta_p = N_p \cdot I_p \text{ (At)}$$

Where  $N_p$  is the number of primary turn (depending on the connection of the primary jumpers)

Caution: As most applications will use the transducer with only one single primary turn ( $N_p = 1$ ), much of this datasheet is written in terms of primary current instead of current linkages. However, the ampere-turns (At) unit is used to emphasis that current linkages are intended and applicable.

### Transducer simplified model

The static model of the transducer at temperature  $T_A$  is:

$$I_S = G \cdot \theta_p + \varepsilon$$

In which  $\varepsilon =$

$$I_{OE} + I_{OT}(T_A) + \varepsilon_G \cdot \theta_p \cdot G + \varepsilon_L(\theta_{Pmax}) \cdot \theta_{Pmax} \cdot G + TCG \cdot (T_A - 25) \cdot \theta_p \cdot G$$

With:

- $\theta_p = N_p \cdot I_p$  : primary current linkage (At)
- $\theta_{Pmax}$  : max primary current linkage applied to the transducer
- $I_S$  : secondary current (A)
- $T_A$  : ambient operating temperature ( $^{\circ}\text{C}$ )
- $I_{OE}$  : electrical offset current (A)
- $I_{OT}(T_A)$  : temperature variation of  $I_o$  at temperature  $T_A$  ( $^{\circ}\text{C}$ )
- $G$  : sensitivity of the transducer (V/At)
- $TCG$  : temperature coefficient of  $G$
- $\varepsilon_G$  : sensitivity error
- $\varepsilon_L(\theta_{Pmax})$  : linearity error for  $\theta_{Pmax}$

This model is valid for primary ampere-turns  $\theta_p$  between  $-\theta_{Pmax}$  and  $+\theta_{Pmax}$  only.

### Sensitivity and linearity

To measure sensitivity and linearity, the primary current (DC) is cycled from 0 to  $I_{PN}$  then to  $-I_{PN}$  and back to 0 (equally spaced  $I_{PN}/10$  steps). The sensitivity  $G$  is defined as the slope of the linear regression line for a cycle between  $\pm I_{PN}$ .

The linearity error  $\varepsilon_L$  is the maximum positive or negative difference between the measured points and the linear regression line, expressed in % of  $I_{PN}$ .

### Magnetic offset

The magnetic offset current  $I_{OM}$  is the consequence of a current on the primary side ("memory effect" of the transducer's ferromagnetic parts). It is measured using the following primary current cycle.  $I_{OM}$  depends on the current value  $I_{P1}$  ( $I_{P1} > I_{PM}$ ).

$$I_{OM} = \frac{V_{out}(t_1) - V_{out}(t_2)}{2} \cdot \frac{1}{G_{tt}}$$

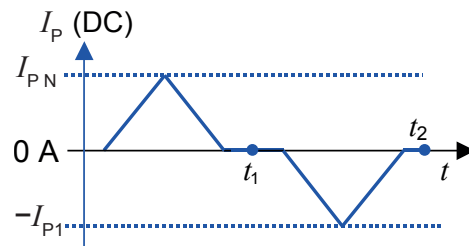

Figure 14: Current cycle used to measure magnetic and electrical offset (transducer supplied)

## Performance parameters definition

### Electrical offset

The electrical offset voltage  $V_{OE}$  can either be measured when the ferro-magnetic parts of the transducer are:

- Completely demagnetized, which is difficult to realize,
- or in a known magnetization state, like in the current cycle shown in figure 14.

Using the current cycle shown in figure 13, the electrical offset is:

$$V_{OE} = \frac{V_{out}(t_1) + V_{out}(t_2)}{2}$$

The temperature variation  $V_{OT}$  of the electrical offset voltage  $V_{OE}$  is the variation of the electrical offset from 25 °C to the considered temperature:

$$V_{OT}(T) = V_{OE}(T) - V_{OE}(25^\circ\text{C})$$

Note: the transducer has to be demagnetized prior to the application of the current cycle (for example with a demagnetization tunnel).

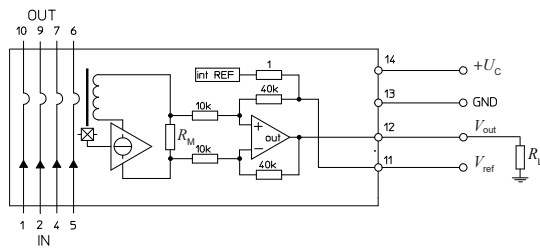

Figure 15: Test connection

### Overall accuracy

The overall accuracy at 25 °C  $X_G$  is the error in the  $-I_{PN} \dots +I_{PN}$  range, relative to the rated value  $I_{PN}$ .

It includes:

- the electrical offset  $V_{OE}$
- the sensitivity error  $\epsilon_G$
- the linearity error  $\epsilon_L$  (to  $I_{PN}$ )

### Response and reaction times

The response time  $t_r$  and the reaction time  $t_{ra}$  are shown in figure 15.

Both depend on the primary current  $di/dt$ . They are measured at nominal ampere-turns.

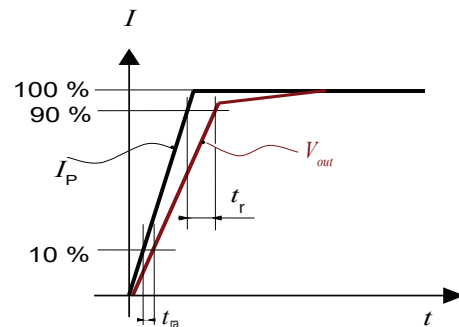

Figure 16: Response time  $t_r$  and reaction time  $t_{ra}$

## Application information

### Filtering and decoupling

#### Supply voltage $U_C$

The transducer has internal decoupling capacitors, but in the case of a power supply with high impedance, it is highly recommended to provide local decoupling (100 nF or more, located close to the transducer) as it may reduce disturbance on transducer output  $V_{out}$  and reference  $V_{ref}$  due to high varying primary current. The transducer power supply rejection ratio is low at high frequency.

#### Output $V_{out}$

The output  $V_{out}$  has a very low output impedance of typically 1 Ohm; it can drive capacitive loads of up to 100 nF directly. Adding series resistance  $R_f$  of several tenths of Ohms allows much larger capacitive loads  $C_f$  (higher than 1  $\mu$ F). Empirical evaluation may be necessary to obtain optimum results. The minimum load resistance on  $V_{out}$  is 1 kOhm.

#### Total Primary Resistance

The primary resistance is 0.72 m $\Omega$  per conductor.

#### Reference $V_{ref}$

Like the output  $V_{out}$ , the  $V_{ref}$  has a very low output impedance of typically 1 Ohm; it can drive capacitive loads of up to 100 nF directly. Adding series resistance  $R_f$  of several tenths of Ohms allows much larger capacitive loads  $C_f$  (higher than 1  $\mu$ F). Empirical evaluation may be necessary to obtain optimum results. The minimum load resistance on  $V_{ref}$  is 10 kOhms.

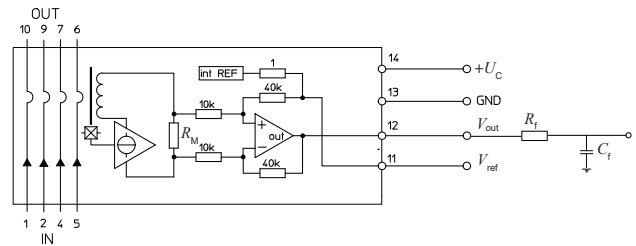

Figure 17: filtered  $V_{out}$  connection

External reference voltage

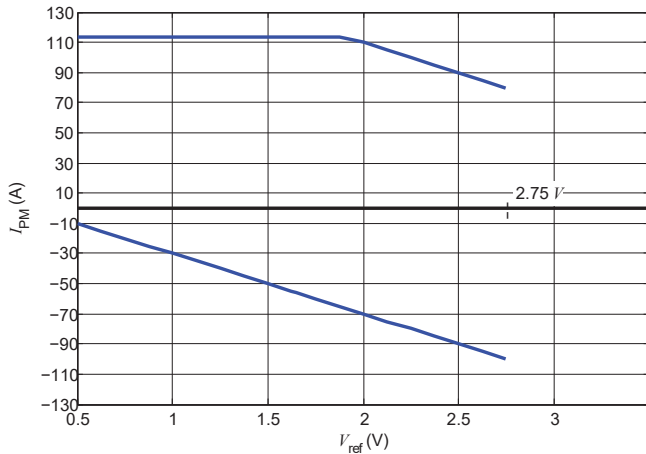

Figure 18: Measuring range versus external  $V_{ref}$   
LESR 25-NP/SP1

Upper limit:  $I_p = -40 * V_{ref} + 190$  ( $V_{ref} = 1.85 \dots 2.75$  V)  
 Upper limit:  $I_p = 113$  ( $V_{ref} = 0 \dots 1.85$  V)  
 Lower limit:  $I_p = -40 * V_{ref} + 10$  ( $V_{ref} = 0 \dots 2.75$  V)

Example with  $V_{ref} = 1.65$  V:

- The 25 A version has a measuring range from -56 A to +113 A
- The 50 A version has a measuring range from -112 A to +150 A

Example with  $V_{ref} = 0.5$  V:

- The 25 A version has a measuring range from -10 A to +113 A
- The 50 A version has a measuring range from -20 A to +150 A

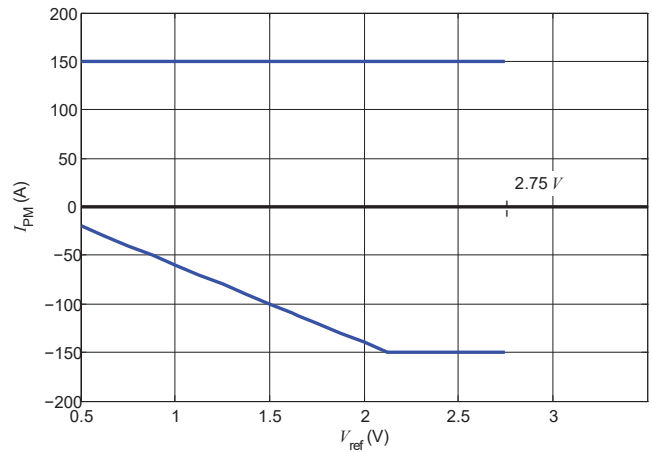
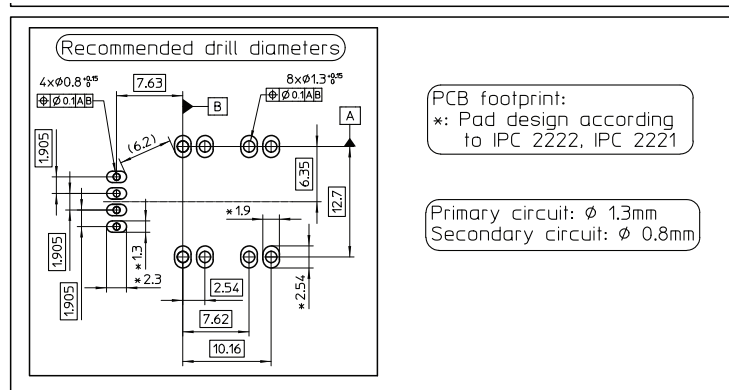

Figure 19: Measuring range versus external  $V_{ref}$   
LESR 50-NP/SP1

Upper limit:  $I_p = 150$  ( $V_{ref} = 0 \dots 2.75$  V)  
 Lower limit:  $I_p = -80 * V_{ref} + 20$  ( $V_{ref} = 0 \dots 2.125$  V)  
 Lower limit:  $I_p = -150$  ( $V_{ref} = 2.125 \dots 2.75$  V)

## PCB footprint



## Assembly on PCB

- Recommended PCB hole diameter: 1.3 mm for primary pin  
0.8 mm for secondary pin
- Maximum PCB thickness: 2.4 mm
- Wave soldering profile: maximum 260 °C for 10 s  
No clean process only

## Safety

This transducer must be used in limited-energy secondary circuits according to IEC 61010-1.



This transducer must be used in electric/electronic equipment with respect to applicable standards and safety requirements in accordance with the manufacturer's operating instructions.

Caution, risk of electrical shock



When operating the transducer, certain parts of the module can carry hazardous voltage (e.g. primary busbar, power supply). Ignoring this warning can lead to injury and/or cause serious damage.

This transducer is a build-in device, whose conducting parts must be inaccessible after installation.

A protective housing or additional shield could be used. Main supply must be able to be disconnected.

## Remark

Installation of the transducer must be done unless otherwise specified on the datasheet, according to LEM Transducer Generic Mounting Rules. Please refer to LEM document N°ANE120504 available on our Web site: [Products/Product Documentation](#).

## Definition of typical, minimum and maximum values

Minimum and maximum values for specified limiting and safety conditions have to be understood as such as well as values shown in "typical" graphs.

On the other hand, measured values are part of a statistical distribution that can be specified by an interval with upper and lower limits and a probability for measured values to lie within this interval.

Unless otherwise stated (e.g. "100 % tested"), the LEM definition for such intervals designated with "min" and "max" is that the probability for values of samples to lie in this interval is 99.73 %.

For a normal (Gaussian) distribution, this corresponds to an interval between -3 sigma and +3 sigma. If "typical" values are not obviously mean or average values, those values are defined to delimit intervals with a probability of 68.27 %, corresponding to an interval between -sigma and +sigma for a normal distribution.

Typical, maximal and minimal values are determined during the initial characterization of the product.

Dimensions (in mm)

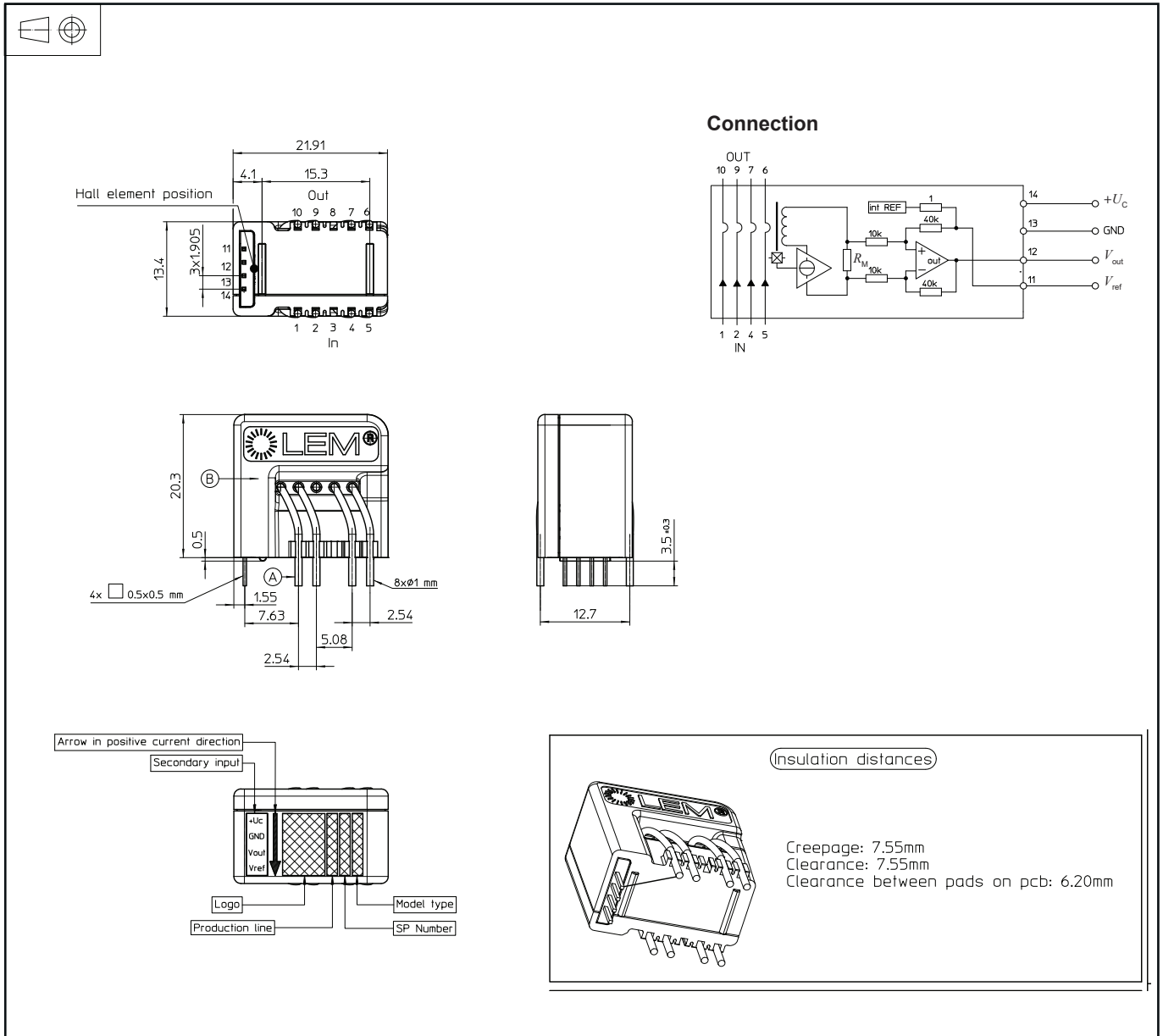

## Packaging information

Standard delivery in cardboard: L × W × H: 315 × 200 × 120 mm

Each cardboard contains 200 parts, placed into 4 Polystyrene-made trays of 50 parts each one.

Both trays and cardboard are ESD-compliant.

The typical weight of the cardboard is 2.5 Kg.

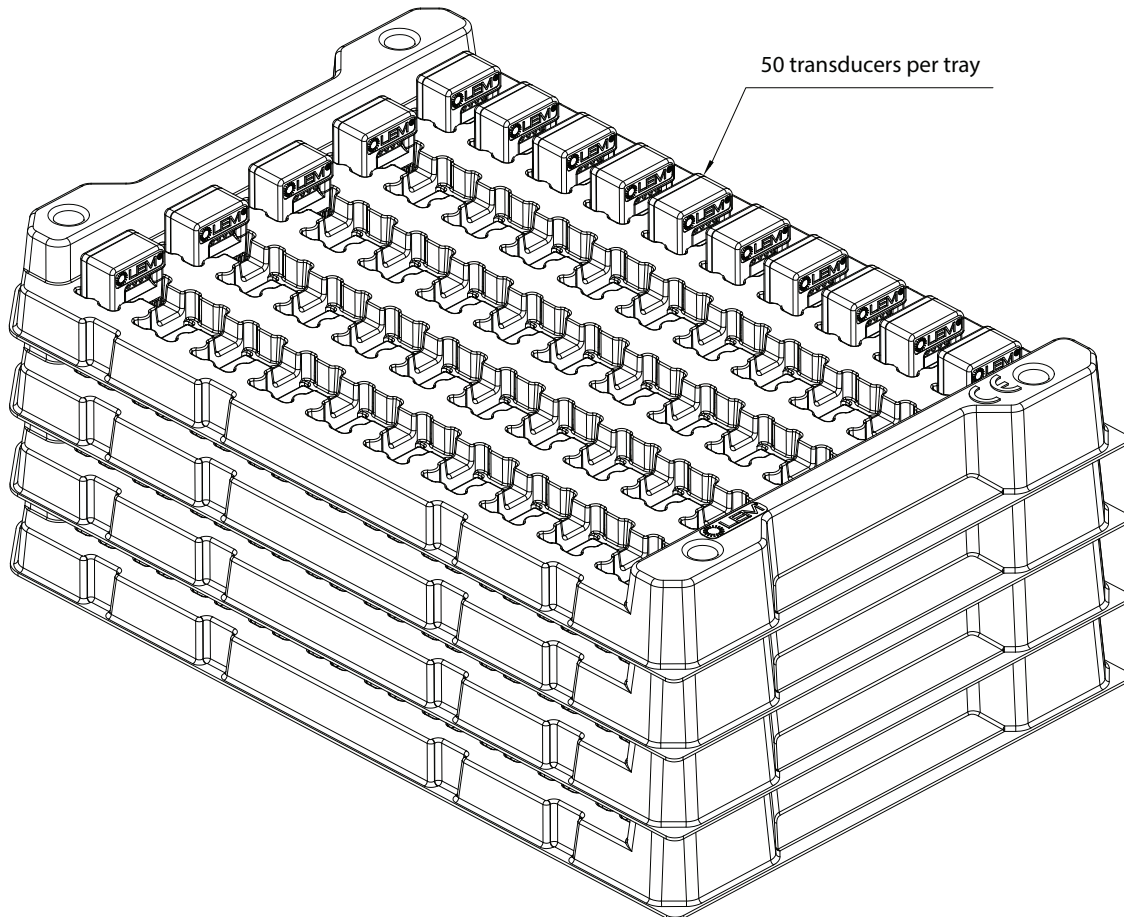

单击下面可查看定价，库存，交付和生命周期等信息

[>>LEM\(莱姆\)](#)