

Ref: **ATO-XXX-B333-D16**

$I_{PN} = 60, 63, 75, 100, 125 A$

ATO series is a split core current transformer for the electronic measurement of AC waveform current with galvanic separation between the primary circuit (power) and the secondary circuit (measurement).

ATO series is an ideal current transformer for new Smart-Grid applications, in which ratio error and phase displacement are fully tested with IEC 61869 standards accordance.

Accuracy Class 1

	A	B	C	D	E	Ø
mm	56.1	19.3	40.8	25.8	33.2	16

Features

- Split-core current transformer
- Rated primary current: 60 A - 63 A - 75 A - 100 A - 125 A
- Application up to 600 V CAT III PD2, basic insulation
- Accuracy class 1 (IEC 61869-2)
- Voltage output 333 mV at I_{Pr}
- Ø 16 mm sensing aperture
- 1 m output cable
- Ambient temperature -10 °C ... +55 °C
- Very low cost solution
- Slot for attaching the C.T. on the primary with plastic tie
- DIN rail adapter (optional).

Advantages

- No interruption of electricity during installation on insulated conductors
- Quick, non-intrusive and easy setup
- Provide a calibrate output.

Applications

- Hybrid inverter (Home Energy Storage)
- Power metering: current measurement for active power calculation
- Building sub-metering: energy efficiency monitoring, consumption analysis and cost allocation
- Power quality monitoring: electrical loads and distribution system equipment
- Distributed measurement systems
- Condition monitoring (e.g. Motor loads such as conveyers, pumps).

Standards

- IEC 61010-1: 2010
- IEC 61010-031 ed1.1: 2012
- IEC 61869-1 ed1.0: 2007
- IEC 61869-2: ed1.0: 2012
- IEC 61869-6: draft 2016
- IEC 61869-10: draft 2016
- UL 508: 2013.

N°52.D3.27.000.0; N°52.D3.G8.000.0; N°52.D3.30.000.0; N°52.D3.34.000.0; N°52.D3.36.000.0;

Page 1/13

5November2019/version 3

LEM reserves the right to carry out modifications on its transducers, in order to improve them, without prior notice

LEM International SA
Chemin des Aulx 8
1228 PLAN-LES-OUATES Switzerland
www.lem.com

LEM City answers the demand for an accurate, reliable and easy to install energy sensor for future Smart Cities.



Absolute maximum ratings

Parameter	Symbol	Unit	Value
Primary conductor temperature	T_B	°C	100

Stresses above these ratings may cause permanent damage.
Exposure to absolute maximum ratings for extended periods may degrade reliability.

UL 508: Ratings and assumptions of certification

File # E189713 Volume: 2 Section: 8

Standards

- CSA C22.2 NO. 14-10 INDUSTRIAL CONTROL EQUIPMENT - Edition 11 - Revision Date 2011/08/01
 - UL 508 STANDARD FOR INDUSTRIAL CONTROL EQUIPMENT - Edition 17 - Revision Date 2013/10/16
- For use only in complete equipment where the acceptability of the combination is determined by UL.LLC.

Ratings

Parameter	Symbol	Unit	Value
Primary involved potential		V AC/DC	1000
Ambient operating temperature	T_A	°C	70
Primary current	I_P	A	125

Conditions of acceptability

When installed in the end-use equipment, consideration shall be given to the following:

- *These devices must be mounted in a suitable end-use enclosure.*
- *The terminals have not been evaluated for field wiring*
- *The products shall be used in a pollution degree 2*
- *Based on results of temperature test, in the end-use application a maximum of 100 °C can not be exceeded on the primary conductor.*

Marking

Only those products bearing the UL or UR Mark should be considered to be Listed or Recognized and covered under UL's Follow-Up Service. Always look for the Mark on the product.

Insulation coordination

Parameter	Symbol	Unit	Value	Comment
RMS voltage for AC insulation test, 50 Hz, 1 min	U_d	kV	4.3	Between primary (completely filling the hole) and secondary
Impulse withstand voltage 1.2/50 μ s	U_{Ni}	kV	7.8	
Partial discharge extinction RMS voltage @ 10 pC	U_e	kV	1.8	
Clearance (pri. - sec.)	d_{Cl}	mm	8	Shortest distance through air
Creepage distance (pri. - sec.)	d_{Cp}	mm	8	Shortest path along device body
Case material flammability	-	--	V0	According to UL 94
Application example	-	V	600	Reinforced insulation according to EN 50178 CAT III PD2
Application example	-	V	300	Reinforced insulation according to EN 61010-1 CAT III PD2
Application example	-	V	600	Basic insulation according to EN 61010-1 CAT IV PD2
Application example	-	V	1000	Basic insulation according to EN 61010-1 CAT III PD2
Application example	-			According to UL 508

Environmental and mechanical characteristics

Parameter	Symbol	Unit	Min	Typ	Max	Comment
Ambient operating temperature	T_A	°C	-10	25	55	
Ambient storage temperature	T_S	°C	-30		90	
Relative humidity (non-condensing)	RH	%	0		85	
Altitude above sea level		m			2000	
Surrounding temperature according to UL		°C			70	
Mass	m	g		120		

Electrical data ATO-60-B333-D16

 At $T_A = 25\text{ °C}$, $R_{br} = 100\text{ k}\Omega$, unless otherwise noted.

Parameter	Symbol	Unit	Min	Value	Max	Comment
Rated burden	R_{br}	k Ω	100			
Rated primary current	I_{Pr}	A		60		
Rated extended primary current	I_{ePr}	A		72		
Rated short-time thermal current	I_{th}	kA			3.6	¹⁾ at 50 Hz; $60 \times I_{Pr}$ (1 s)
Rated dynamic current	I_{dyn}	kA			9	at 50 Hz; $2.5 \times I_{th}$
Rated transformation ratio	k_{ra}	A/V		180		
Rated secondary voltage	U_{Sr}	mV		333		
Rated frequency	f_r	Hz		50/60		

Parameter	Symbol	Unit	Min	Typ	Max	Comment
Frequency bandwidth (-3 dB)	BW	kHz	1.5			²⁾ Short circuit condition (no load)
Phase displacement	$\Delta\varphi$	°	-1		1	³⁾ (-10 °C ... 55 °C) Details page 10
Temperature coefficient of I_{out}	TCI_{out}	ppm/k			80	
Ratio error	ε	%	-1		1	³⁾ (-10 °C ... 55 °C) Details page 10
Linearity error	ε_L	%	-0.1		0.1	
Influence of external current	$\varepsilon_{I_{ext}}$	%		0.3		

- Notes:**
- ¹⁾ No test conducted given that is the worst case (load = 100 k Ω i.e short circuit on the output) the peak dissipated power remains low.
 - ²⁾ Frequency bandwidth and phase shift modeling schematic can be provided on request.
 - ³⁾ Considering a primary conductor of at least $\varnothing 9\text{ mm}$ perpendicular to the current transformer. All our **LEMcity** transducers class I are tested at 5 %, 20 % 100 % and 120 % of I_{Pr} to be according to IEC61869-2 table 201.

Electrical data ATO-63-B333-D16

 At $T_A = 25\text{ °C}$, $R_{br} = 100\text{ k}\Omega$, unless otherwise noted.

Parameter	Symbol	Unit	Min	Value	Max	Comment
Rated burden	R_{br}	k Ω	100			
Rated primary current	I_{Pr}	A		63		
Rated extended primary current	I_{ePr}	A		75.6		
Rated short-time thermal current	I_{th}	kA			3.78	¹⁾ at 50 Hz; $60 \times I_{Pr}$ (1 s)
Rated dynamic current	I_{dyn}	kA			9.45	at 50 Hz; $2.5 \times I_{th}$
Rated transformation ratio	k_{ra}	A/V		189		
Rated secondary voltage	U_{Sr}	mV		333		
Rated frequency	f_r	Hz		50/60		

Parameter	Symbol	Unit	Min	Typ	Max	Comment
Frequency bandwidth (-3 dB)	BW	kHz	1.5			²⁾ Short circuit condition (no load)
Phase displacement	$\Delta\varphi$	°	-1		1	³⁾ (-10 °C ... 55 °C) Details page 10
Temperature coefficient of I_{out}	TCI_{out}	ppm/k			80	
Ratio error	ε	%	-1		1	³⁾ (-10 °C ... 55 °C) Details page 10
Linearity error	ε_L	%	-0.1		0.1	
Influence of external current	$\varepsilon_{I_{ext}}$	%		0.3		

- Notes:**
- ¹⁾ No test conducted given that is the worst case (load = 100 k Ω .e short circuit on the output) the peak dissipated power remains low.
 - ²⁾ Frequency bandwidth and phase shift modeling schematic can be provided on request.
 - ³⁾ Considering a primary conductor of at least $\varnothing 9\text{ mm}$ perpendicular to the current transformer. All our **LEMcity** transducers class I are tested at 5 %, 20 % 100 % and 120 % of I_{Pr} to be according to IEC61869-2 table 201.

Electrical data ATO-75-B333-D16

 At $T_A = 25\text{ °C}$, $R_{br} = 100\text{ k}\Omega$, unless otherwise noted.

Parameter	Symbol	Unit	Min	Value	Max	Comment
Rated burden	R_{br}	k Ω	100			
Rated primary current	I_{Pr}	A		75		
Rated extended primary current	I_{ePr}	A		90		
Rated short-time thermal current	I_{th}	kA			4.5	¹⁾ at 50 Hz; $60 \times I_{Pr}$ (1 s)
Rated dynamic current	I_{dyn}	kA			11.25	at 50 Hz; $2.5 \times I_{th}$
Rated transformation ratio	k_{ra}	A/V		225		
Rated secondary voltage	U_{Sr}	mV		333		
Rated frequency	f_r	Hz		50/60		

Parameter	Symbol	Unit	Min	Typ	Max	Comment
Frequency bandwidth (-3 dB)	BW	kHz	1.5			²⁾ Short circuit condition (no load)
Phase displacement	$\Delta\varphi$	°	-1		1	³⁾ (-10 °C ... 55 °C) Details page 10
Temperature coefficient of I_{out}	TCI_{out}	ppm/k			80	
Ratio error	ε	%	-1		1	³⁾ (-10 °C ... 55 °C) Details page 10
Linearity error	ε_L	%	-0.1		0.1	
Influence of external current	$\varepsilon_{I_{ext}}$	%		0.3		

- Notes:**
- ¹⁾ No test conducted given that is the worst case (load = 100 k Ω i.e short circuit on the output) the peak dissipated power remains low.
 - ²⁾ Frequency bandwidth and phase shift modeling schematic can be provided on request.
 - ³⁾ Considering a primary conductor of at least $\varnothing 9\text{ mm}$ perpendicular to the current transformer. All our **LEMcity** transducers class I are tested at 5 %, 20 % 100 % and 120 % of I_{Pr} to be according to IEC61869-2 table 201.

Electrical data ATO-100-B333-D16

 At $T_A = 25\text{ °C}$, $R_{br} = 100\text{ k}\Omega$, unless otherwise noted.

Parameter	Symbol	Unit	Min	Value	Max	Comment
Rated burden	R_{br}	k Ω	100			
Rated primary current	I_{Pr}	A		100		
Rated extended primary current	I_{ePr}	A		120		
Rated short-time thermal current	I_{th}	kA			6	¹⁾ at 50 Hz; $60 \times I_{Pr}$ (1 s)
Rated dynamic current	I_{dyn}	kA			3	at 50 Hz; $2.5 \times I_{th}$
Rated transformation ratio	k_{ra}	A/V		300		
Rated secondary voltage	U_{Sr}	mV		333		
Rated frequency	f_r	Hz		50/60		

Parameter	Symbol	Unit	Min	Typ	Max	Comment
Frequency bandwidth (-3 dB)	BW	kHz	1.5			²⁾ Short circuit condition (no load)
Phase displacement	$\Delta\varphi$	°	-1		1	³⁾ (-10 °C ... 55 °C) Details page 10
Temperature coefficient of I_{out}	TCI_{out}	ppm/k			80	
Ratio error	ε	%	-1		1	³⁾ (-10 °C ... 55 °C) Details page 10
Linearity error	ε_L	%	-0.1		0.1	
Influence of external current	$\varepsilon_{I_{ext}}$	%		0.3		

- Notes:**
- ¹⁾ No test conducted given that is the worst case (load = 100 k Ω .e short circuit on the output) the peak dissipated power remains low.
 - ²⁾ Frequency bandwidth and phase shift modeling schematic can be provided on request.
 - ³⁾ Considering a primary conductor of at least $\varnothing 9\text{ mm}$ perpendicular to the current transformer. All our **LEMcity** transducers class I are tested at 5 %, 20 % 100 % and 120 % of I_{Pr} to be according to IEC61869-2 table 201.

Electrical data ATO-125-B333-D16

 At $T_A = 25\text{ °C}$, $R_{br} = 100\text{ k}\Omega$, unless otherwise noted.

Parameter	Symbol	Unit	Min	Value	Max	Comment
Rated burden	R_{br}	k Ω	100			
Rated primary current	I_{Pr}	A		125		
Rated extended primary current	I_{ePr}	A		150		
Rated short-time thermal current	I_{th}	kA			7.5	¹⁾ at 50 Hz; $60 \times I_{Pr}$ (1 s)
Rated dynamic current	I_{dyn}	kA			18.75	at 50 Hz; $2.5 \times I_{th}$
Rated transformation ratio	k_{ra}	A/V		375		
Rated secondary voltage	U_{Sr}	mV		333		
Rated frequency	f_r	Hz		50/60		

Parameter	Symbol	Unit	Min	Typ	Max	Comment
Frequency bandwidth (-3 dB)	BW	kHz	1.5			²⁾ Short circuit condition (no load)
Phase displacement	$\Delta\varphi$	°	-1		1	³⁾ (-10 °C ... 55 °C) Details page 10
Temperature coefficient of I_{out}	TCI_{out}	ppm/k			80	
Ratio error	ε	%	-1		1	³⁾ (-10 °C ... 55 °C) Details page 10
Linearity error	ε_L	%	-0.1		0.1	
Influence of external current	$\varepsilon_{I_{ext}}$	%		0.3		

- Notes:**
- ¹⁾ No test conducted given that is the worst case (load = 100 k Ω .e short circuit on the output) the peak dissipated power remains low.
 - ²⁾ Frequency bandwidth and phase shift modeling schematic can be provided on request.
 - ³⁾ Considering a primary conductor of at least $\varnothing 9\text{ mm}$ perpendicular to the current transformer. All our **LEMcity** transducers class I are tested at 5 %, 20 % 100 % and 120 % of I_{Pr} to be according to IEC61869-2 table 201.

Typical performance characteristics
Accuracy class 1 according to IEC 61869-2

At $T_A = 25\text{ }^\circ\text{C}$, at frequency = 50 Hz, $R_{br} = 100\text{ k}\Omega$, unless otherwise noted.

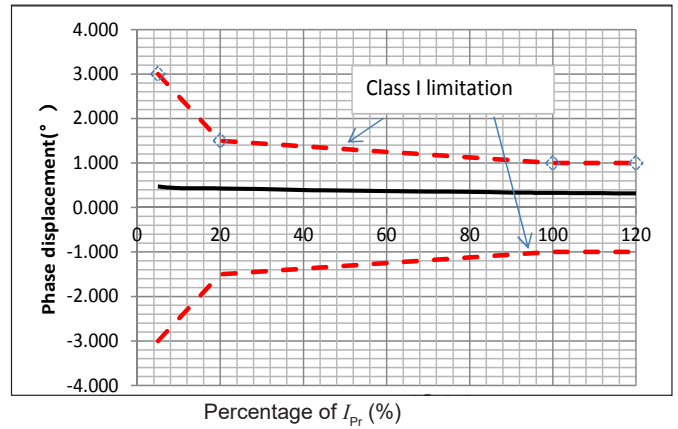
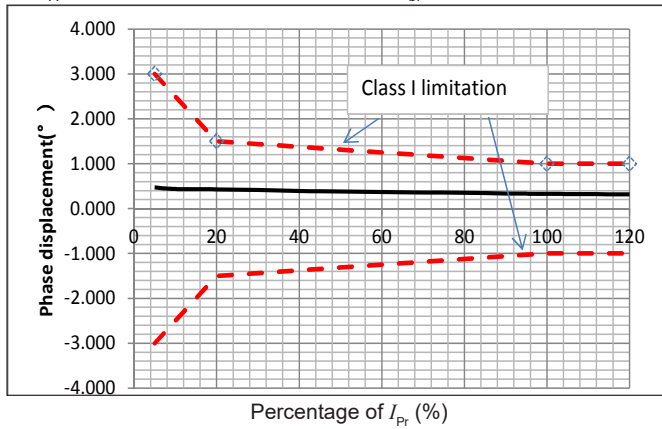

Figure 1: Accuracy vs. primary current

Figure 2: Phase displacement vs. primary current

% of I_{Pr}	Ratio error				Phase displacement			
	5 %	20 %	100 %	120 %	5 %	20 %	100 %	120 %
Maximum	3.0 %	1.5 %	1.0 %	1.0 %	3.0°	1.5°	1.0°	1.0°
Minimum	-3.0 %	-1.5 %	-1.0 %	-1.0 %	-3.0°	-1.5°	-1.0°	-1.0°

At $T_A = 25\text{ }^\circ\text{C}$, at frequency = 60 Hz, $R_{br} = 100\text{ k}\Omega$, unless otherwise noted.

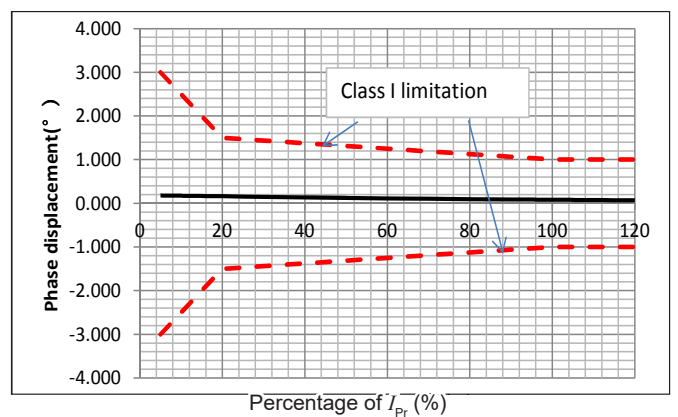
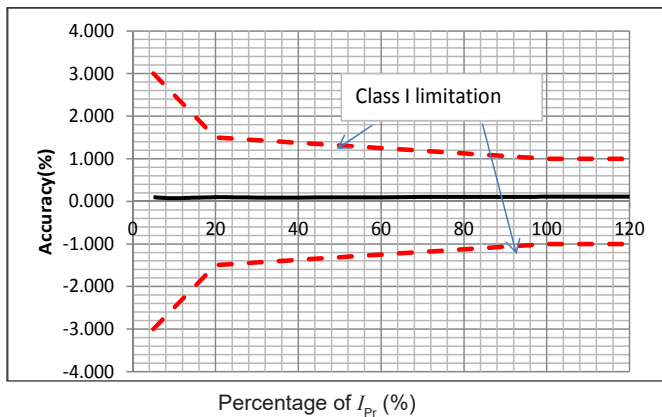

Figure 3: Accuracy vs. primary current

Figure 4: Phase displacement vs. primary current

% of I_{Pr}	Ratio error				Phase displacement			
	5 %	20 %	100 %	120 %	5 %	20 %	100 %	120 %
Maximum	3.0 %	1.5 %	1.0 %	1.0 %	3.0°	1.5°	1.0°	1.0°
Minimum	-3.0 %	-1.5 %	-1.0 %	-1.0 %	-3.0°	-1.5°	-1.0°	-1.0°

Performance parameters definition

Rated transformation ratio K_{ra}

Ratio of K_{ra} to the actual secondary voltage or current.

Ratio error ε

The current ratio error, expressed in per cent, is given by the formula:

$$\varepsilon = \frac{k_{ra} I_s - I_p}{I_p} \times 100 \%$$

Where:

K_{ra} : is the rated transformation ratio

I_p : is the actual primary current

I_s : is the actual secondary current when I_p is flowing, under the conditions of measurement

Phase displacement $\Delta\varphi$

The $\Delta\varphi$ is the difference in phase between the primary voltage or current and the secondary voltage or current phasors. The direction of the phasors being so chosen that the angle is zero for an ideal transformer.

The phase displacement is said to be positive when the secondary voltage or current phasors leads the primary voltage or current phasors.

Linearity error ε_L

The linearity error ε_L is the maximum positive or negative difference between the measured points and a corresponding linear regression line, expressed in % of I_{pr} .

Rated short-time thermal current I_{th}

Maximum value of the primary current which a transformer will withstand for a specified short time without suffering harmful effects, the secondary winding being short-circuited.

Rated dynamic current I_{dyn}

Maximum peak value of the primary current which a transformer will withstand, without being damaged electrically or mechanically by the resulting electromagnetic forces, the secondary winding being short-circuited.

ATO-XXX-B333-D16 series: name and codification

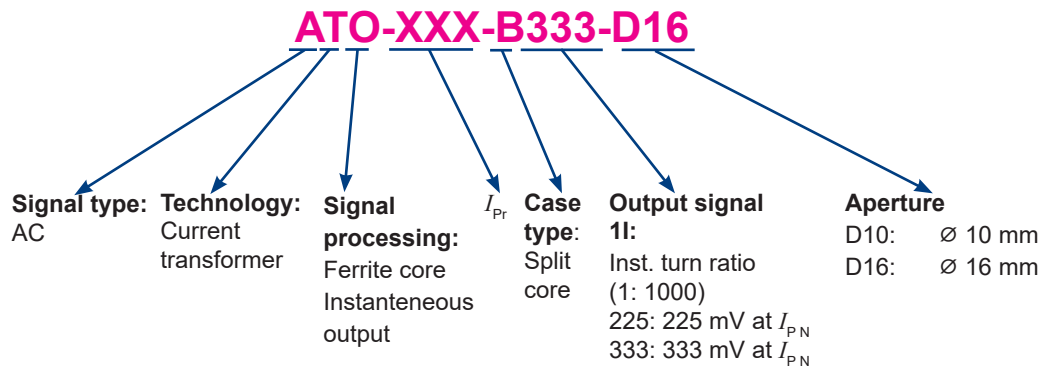

Safety and warning notes

In order to guarantee safe operation of the transducer and to be able to make proper use of all features and functions, please read these instructions thoroughly!

Safe operation can only be guaranteed if the transducer is used for the purpose it has been designed for and within the limits of the technical specifications.

Ensure you get up-to-date technical information that can be found in the latest associated datasheet under www.lem.com.



Caution! Risk of danger

Ignoring the warnings can lead to serious injury and/or cause damage! The electric measuring transducer may only be installed and put into operation by qualified personnel that have received an appropriate training.

The corresponding national regulations shall be observed during installation and operation of the transducer and any electrical conductor.

The transducer shall be used in electric/electronic equipment with respect to applicable standards and safety requirements and in accordance with all the related systems and components manufacturers' operating instructions.



Caution! Risk of electrical shock

When operating the transducer, certain parts of the module may carry hazardous live voltage (e.g. primary conductor). The user shall ensure to take all measures necessary to protect against electrical shock. The transducer is a build-in device containing conducting parts that shall not be accessible after installation. A protective enclosure or additional insulation barrier may be necessary. Installation and maintenance shall be done with the main power supply disconnected except if there are no hazardous live parts in or in close proximity to the system and if the applicable national regulations are fully observed.

Safe and trouble-free operation of this transducer can only be guaranteed if transport, storage and installation are carried out correctly and operation and maintenance are carried out with care.

Dimensions (in mm)

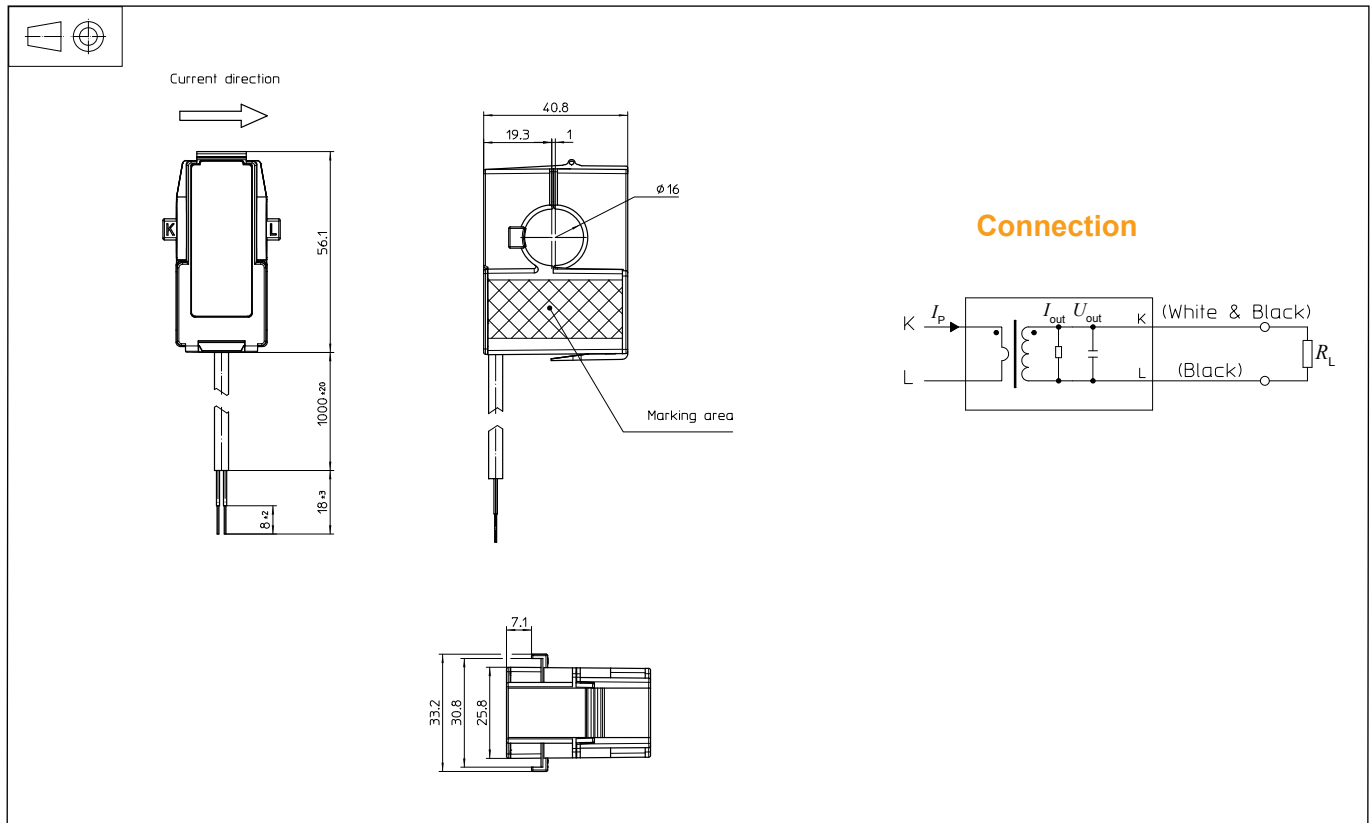

Mechanical characteristics

- General tolerance ± 0.5 mm
- Primary aperture $\varnothing 16$ mm
- Fastening Cable tie
- Output cable length 1 m

Remarks

- Attention: contact areas (air gap) must be kept clean (particle free) to ensure proper performance
- Installation of the transducer must be done unless otherwise specified on the datasheet, according to LEM Transducer Generic Mounting Rules. Please refer to LEM document N°ANE120504 available on our Web site: <https://www.lem.com/en/file/3137/download/>.

DIN RAIL ADAPTOR (additional part option) dimensions (in mm)

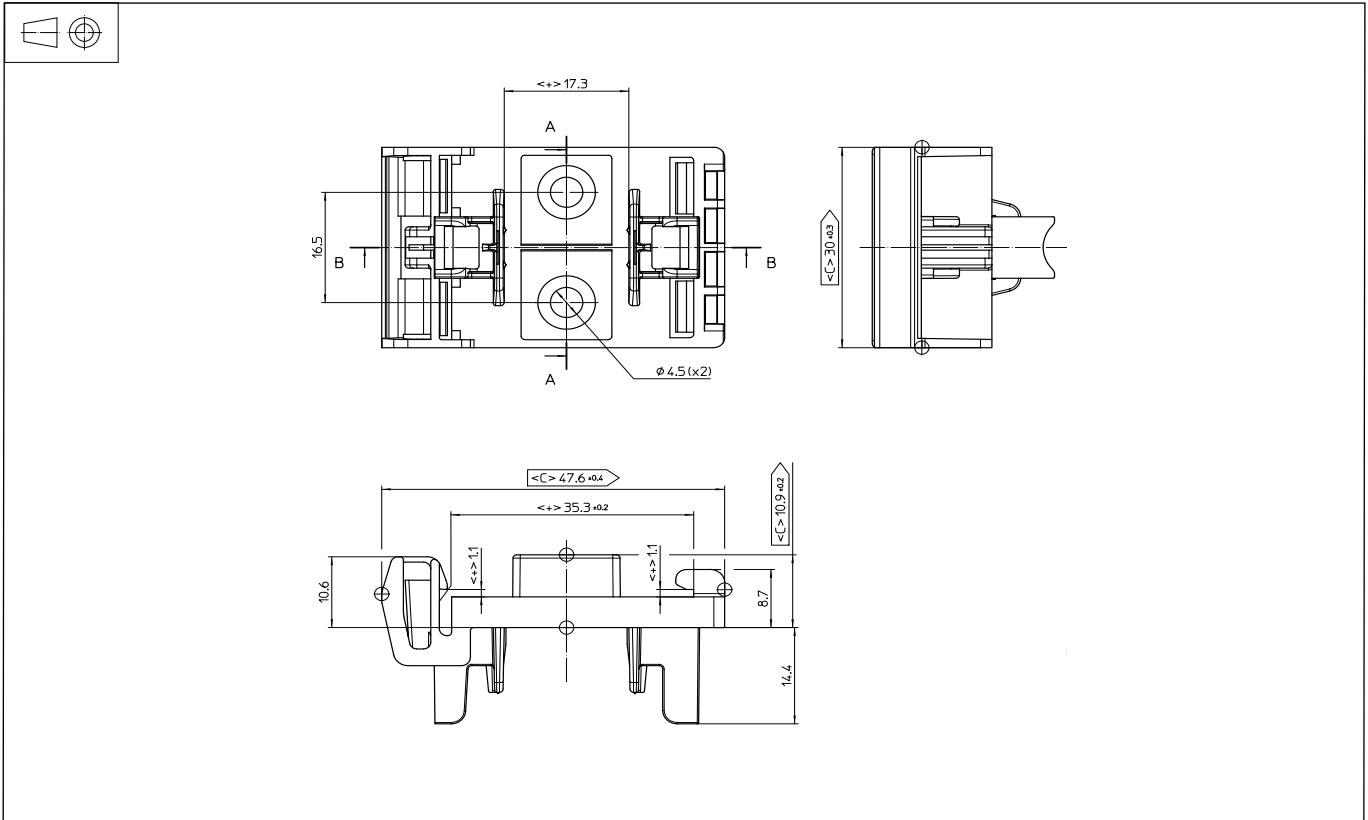

LEM Reference:70.D5.98.000.0

Mechanical characteristics

- General tolerance ± 0.4 mm
- Fastening 1.5 N·m

Remarks

- Attention: contact areas (air gap) must be kept clean (particle free) to ensure proper performance
- Installation of the transducer must be done unless otherwise specified on the datasheet, according to LEM Transducer Generic Mounting Rules. Please refer to LEM document N°ANE120504 available on our Web site:

<https://www.lem.com/en/file/3137/download/>.

单击下面可查看定价，库存，交付和生命周期等信息

[>>LEM\(莱姆\)](#)