



# PU35CL1 V0

## Product Specification (**Preliminary**)

## Approval Sheet

PU35CL1 V0  
Product Specification

RoHS

<b>Product</b>	UVC 3535 Emitter
<b>Part Number</b>	PU35CL1 V0
<b>Issue Date</b>	2019/12/03



### ■ Feature

- ✓ UVC LED
- ✓ Compact dimensions: 3.5 mm × 3.5 mm × 1.45 mm
- ✓ Dice Technology : AlGaN
- ✓ View angle:  $\theta = 125^\circ$
- ✓ Environmental friendly ; RoHS compliance
- ✓ Packing : 250 & 500 pcs/reel

### ■ Applications

- ✓ Sterilization
- ✓ Water purification
- ✓ Air purification

## Outline Dimension

PU35CM1 V0  
Product Specification

### Outline Dimension

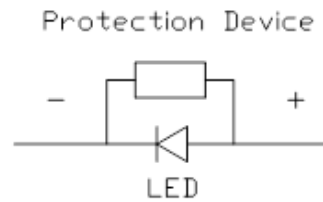
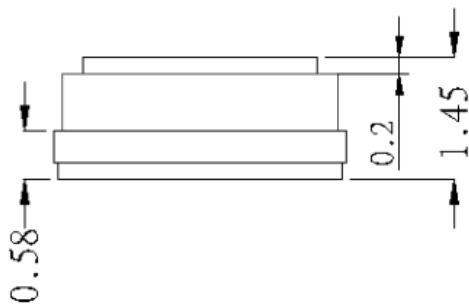
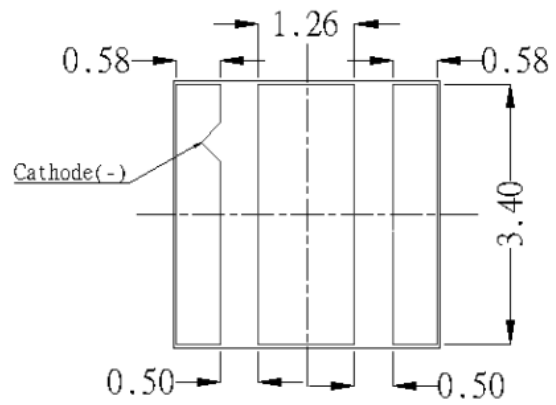
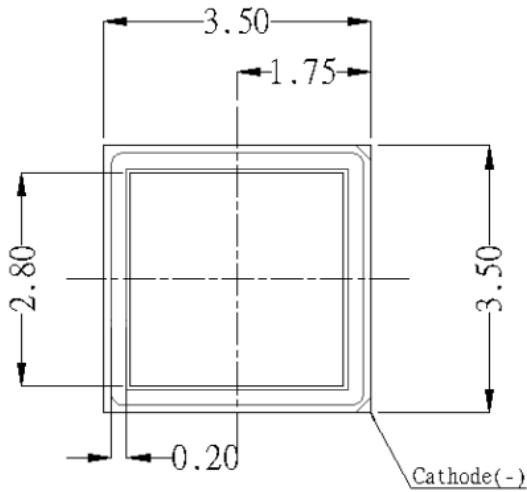

\*. Tolerance:  $\pm 0.15\text{mm}$

Performance

PU35CL1 V0  
 Product Specification

**Opto-Electrical Characteristics**

Parameter	Symbol	Condition	Min.	Typ.	Max.	Unit
Radiant Power <sup>*(1)</sup>	$P_O$	$I_F = 20\text{mA}$	1.8	2.4	2.7	mW
Forward Voltage <sup>*(2)</sup>	$V_F$		5.0	6.0	8.0	V
Wavelength <sup>*(3)</sup>	$W_P$		270	278	285	nm
Thermal Resistance <sup>*(4)</sup>	$R_{th}$		--	20	--	$^{\circ}\text{C}/\text{W}$
View Angle	$\theta$		--	125	--	deg
Reverse Current	$I_R$	$V_R = 5\text{V}$			10	$\mu\text{A}$

- (1).The Radiant Power tolerance  $\pm 10\%$
- (2).The Forward Voltage tolerance is  $\pm 0.1\text{V}$
- (3).Peak Wavelength tolerance is  $\pm 5\text{nm}$
- (4).Thermal resistance is calculated from junction to solder

**Absolute Maximum Ratings**

Parameter	Symbol	Value	Unit
DC Forward Current	$I_F$	30	mA
ESD	$V_{ESD}$	8000	V
Power Dissipation	$P_d$	0.18	W
Soldering Temperature <sup>*(1)</sup>	$T_S$	260	$^{\circ}\text{C}$
Storage Temperature	$T_{Stg}$	-40~+100	$^{\circ}\text{C}$
Operation Temperature	$T_{Op}$	-30~+60	$^{\circ}\text{C}$

- (1) JEDEC STD-020 latest version compliant.
- (2) Proper current rating must be observed to maintain junction temperature below  $T_j$  max.

**Binning**

PU35CL1 V0  
 Product Specification

**Bin code definition**

Wp Rank	P <sub>O</sub> Rank	V <sub>F</sub> Rank
U0270	B4	4

**Wavelength Rank (Ta=25°C)**

Condition	W <sub>P</sub> Rank	Min.	Max.	Unit
I <sub>F</sub> =20mA	U0270	270	280	nm
	U0280	280	290	

**Radiant Power Rank (Ta=25°C)**

Condition	P <sub>O</sub> Rank	Min.	Max.	Unit
I <sub>F</sub> =20mA	A1	1.5	2.0	mW
	A2	2.0	2.5	
	A3	2.5	3.0	
	A4	3.0	4.0	
	A5	4.0	4.5	
	A6	4.5	5.0	

**Forward Voltage Rank (Ta=25°C)**

Condition	V <sub>F</sub> Rank	Min.	Max.	Unit
I <sub>F</sub> =20mA	1	4.0	4.5	V
	2	4.5	5.0	
	3	5.0	5.5	
	4	5.5	6.0	
	5	6.0	6.5	
	6	6.5	7.0	
	7	7.0	7.5	
	8	7.5	8.0	

# Characteristics

PU35CL1 V0

Product Specification

## Relative Radiant Flux vs. Forward Current

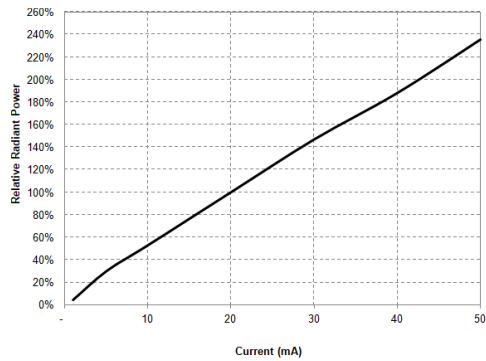

## Forward Current vs. Peak Wavelength

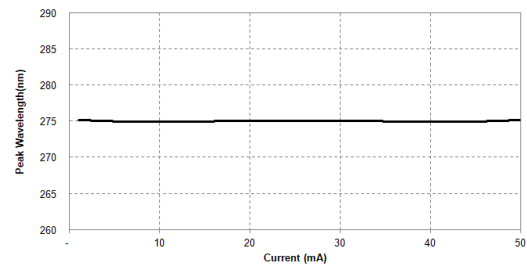

## Forward Current vs. Forward Voltage at 25°C

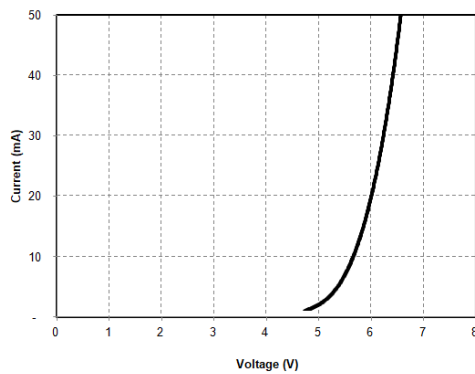

## Relative radiant flux vs. Ambient Temperature

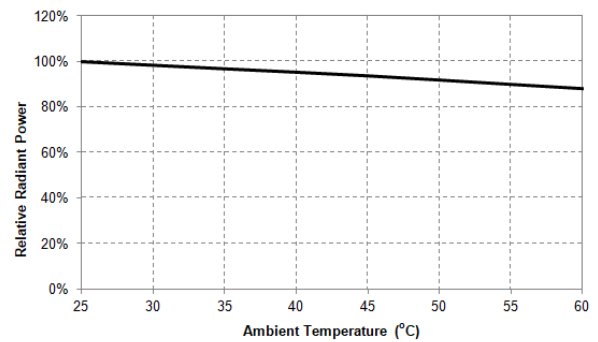

## Derating Curve

TBD

## Typical Spatial Distribution

TBD

# Packing

PU35CL1 V0

Product Specification

## Label

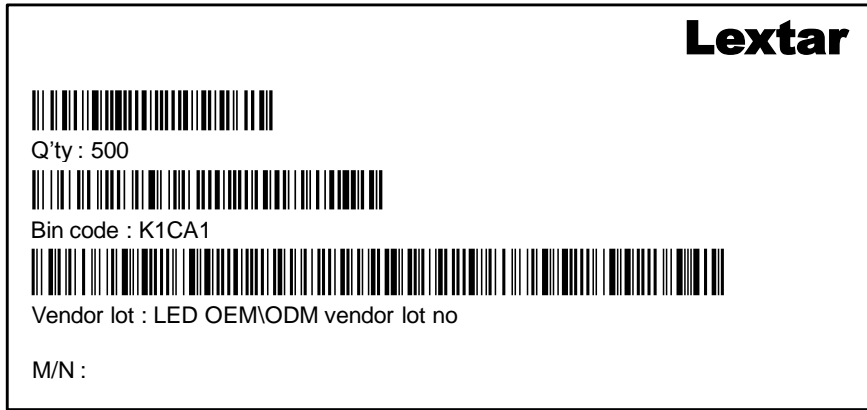

## Packing process

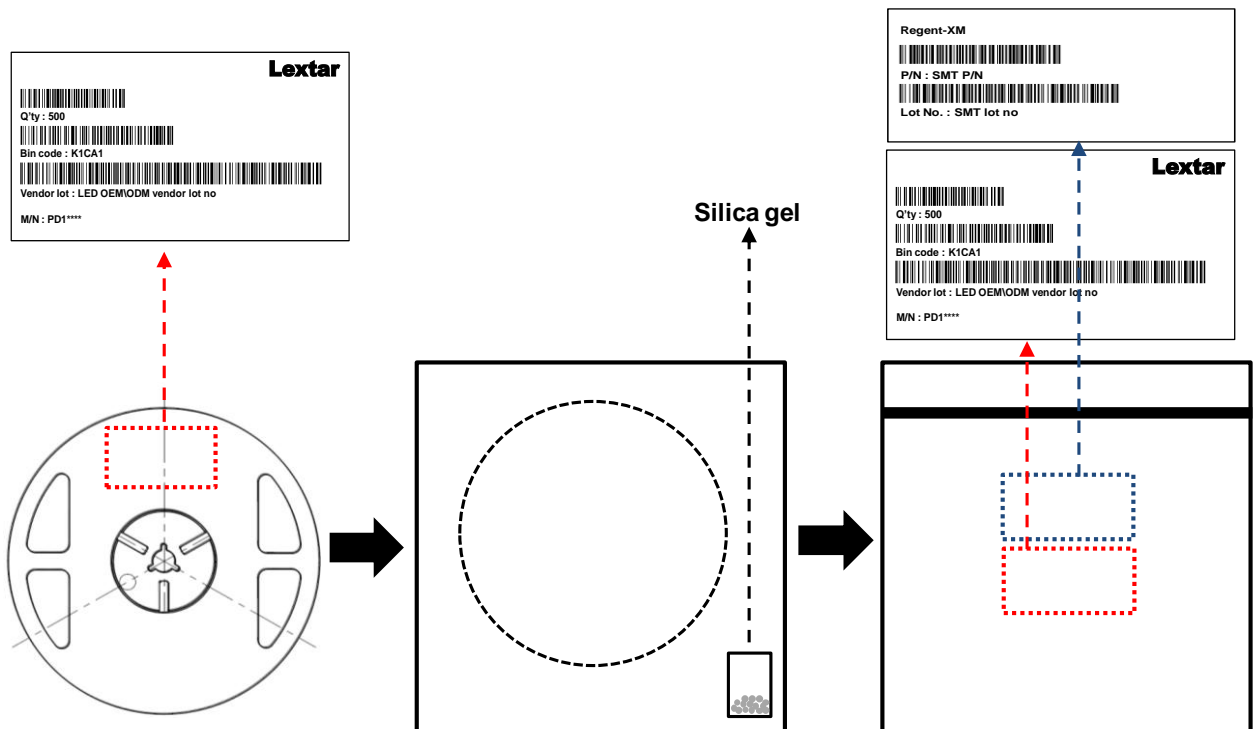

**Packing**

PU35CL1 V0  
 Product Specification

**Carrier dimensions**

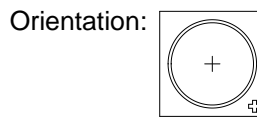
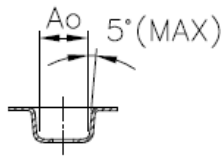
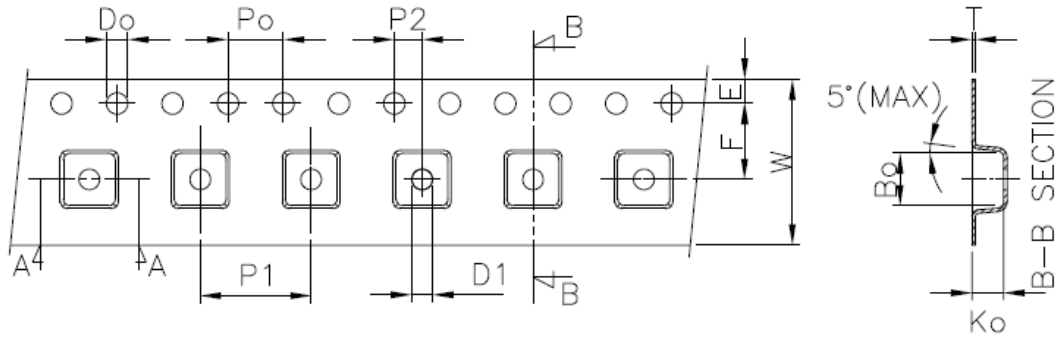

A-A SECTION

UNIT:mm

Symbol	Ao	Bo	Ko	Po	P1	P2	T
Spec	3.72±0.10	3.72±0.10	2.7±0.10	4.00±0.10	8.00±0.10	2.00±0.10	0.25±0.10
Symbol	E	F	Do	D1	W	10Po	--
Spec	1.75±0.10	5.5±0.05	1.55±0.05	1.50±0.10	12.0±0.30	40.0±0.20	--

**USER REEL DIRECTION**

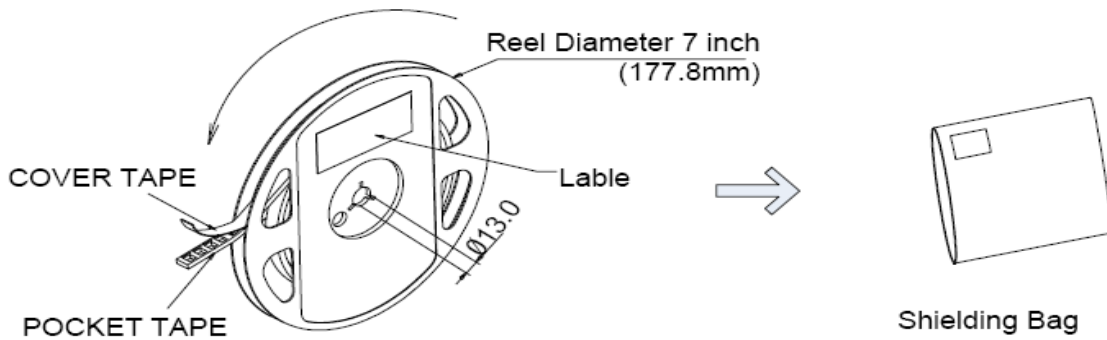

**7 inch Anti-Static Reel**

Max 500pcs/reel

Min 250pcs/reel



## Packing

PU35CL1 V0

Product Specification

### ■ Small Box

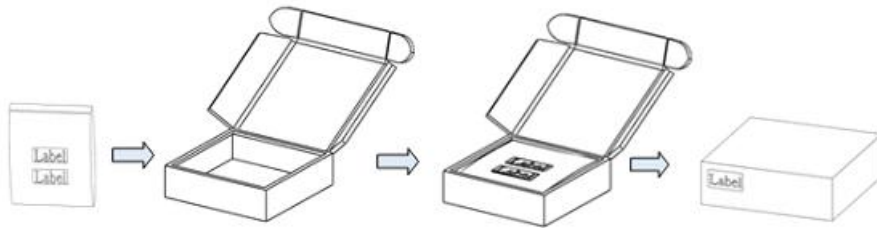

### ■ Medium Box

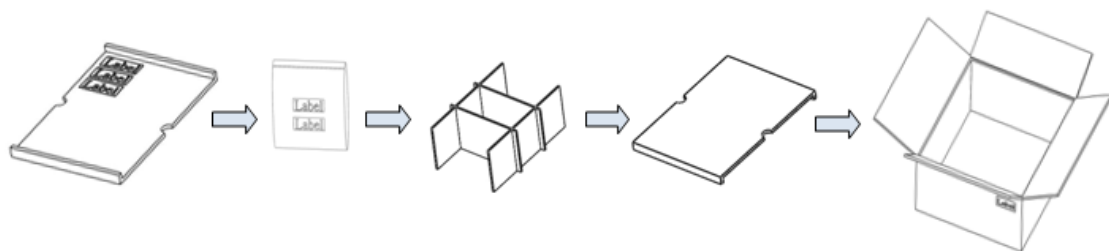

### ■ Large Box

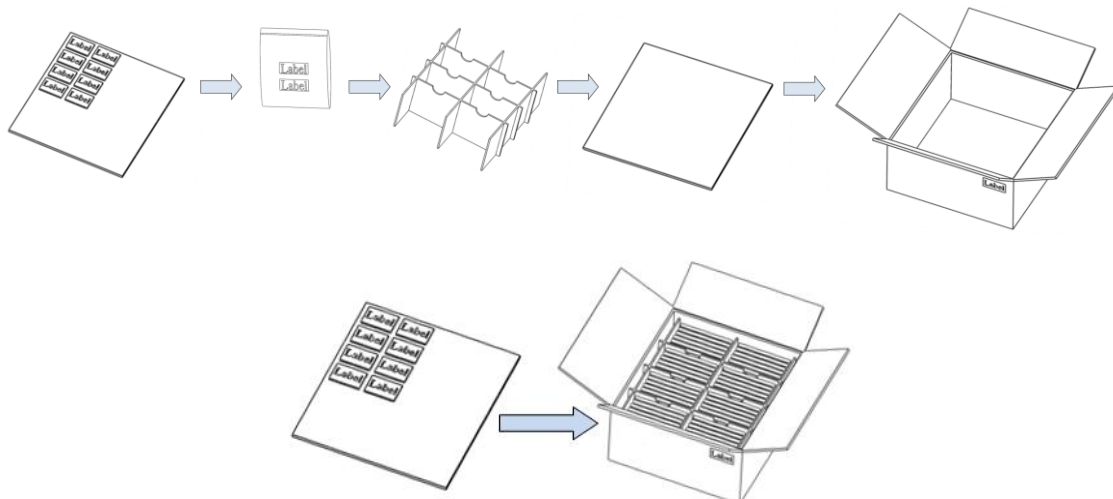

## Application Notes

PU35CL1 V0

Product Specification

### ■ Soldering PAD Design

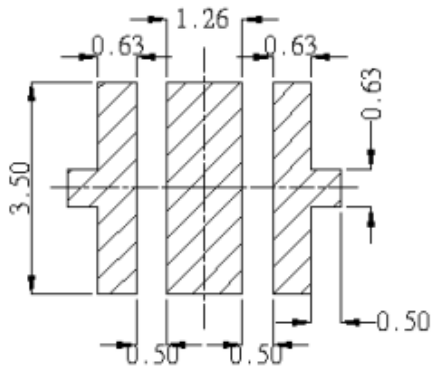

Recommended Solder Pad

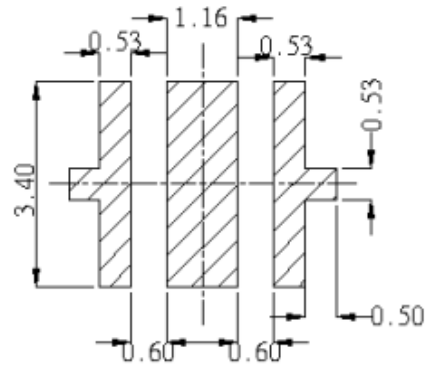

Recommended Stencil Pattern

### ■ Recommended Reflow Soldering Profile (JEDEC-STD-020 latest version compliant)

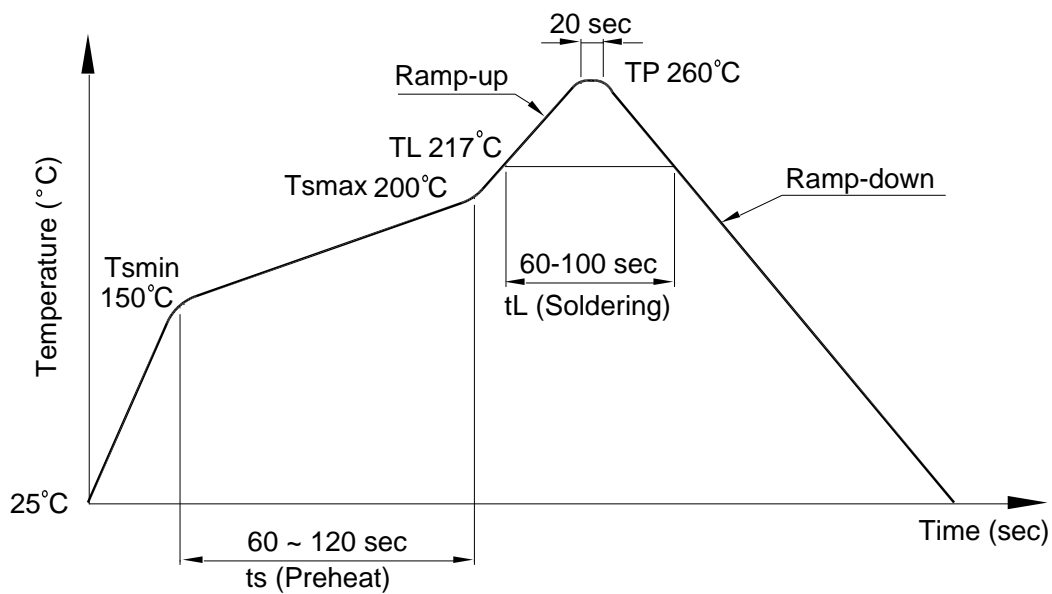

Profile Items	Conditions
Preheat	
-Temperature Min.( $T_{Smin}$ )	150°C
-Temperature Max.( $T_{Smax}$ )	200°C
-Time(Min. to Max.)( $t_S$ )	90±30 sec
Soldering Zone	
-Temperature( $T_L$ )	217°C
-Time	60~100 sec
Peak Temperature( $T_P$ )	260°C
Ramp-up rate	3°C / sec max.
Ramp-down rate	3~6°C / sec

**Note:**

1. One time soldering is recommended; do not exceed 3 times reflow process.
2. The recommended peak temperature is 245°C. The maximum soldering temperature should be controlled under 260°C.

## Precautions

PU35CL1 V0

Product Specification

### ■ Use Applications

- The products are not intended to any application which is not specified in this document. For other application, please be noted that a different product may be required. If you have any concerns, please contact us before using the products in your desired application. This specification guarantees the quality and performance of the products as an individual component. Do not use the products beyond the use case and use environment that the specification has described in this document. We assume no responsibility and liability for any lost and damage resulting from the use or operation of the products which do not comply with any absolute maximum ratings, warnings, restrictions and instructions recited in these specification sheets or other forms of notices from us or resulting from the use or operation of the products under non-standard environment or operations.

### ■ Cautions

- All measurement data is taken from standard laboratory procedures on each discrete product. The procedure does not work on any product integrating components and materials not provided by us. The measurement is provided for your reference and evaluation on your integrated products only. Therefore the products should always be cautiously used with other parts on your own. It is your or your customer's responsibility to perform sufficient tests under your expected environment prior to use the products with other parts to ensure that the lifetime and other quality characteristics required for the actual use in real life are met. During your tests, it is recommended to actively consult with us instantly while there is any concern or inconsistency about the discrete LED. Caution: While using under non-standard environment, application or non-approval operations, be aware of malfunctions or damages leads to risks of life or health.
- You will not reverse engineer, disassemble or otherwise attempt to extract knowledge/design information from the products. In the case of any incident or quality concern that appears to be in breach of these specifications, the products in question must be reported to our local sales representatives for further instructions. Please ensure that the products in question are not disassembled or removed from the PCBs (if any). The determination of whether the products in question are defective and are required for any corrective action thereafter shall be made by us in accordance with our cause analysis procedure. If you do not agree with our cause analysis result, you may

request us to send the products in question to a mutually agreed third party for inspection. The cost of such third party inspection shall be borne by you unless it is determined by such third party that said quality issue is solely attributable to us. In the above case, our sole and exclusive obligation shall be, either to repair, replace or refund the products in question.

- All previous negotiation and agreements not specifically incorporated herein are superseded and rendered null and void. We assume no liability with respect to defects and/or issues of the products caused by: alternation, modification, change, repair and attempt to repair of the products by a party other than us; not caused by our negligent, gross negligent, reckless, or other improper use of the LEDs; installation, operation, or maintenance of the products by a party other than us and not in a manner described in the instruction manual, if applicable; and combination of a product not supplied by us.

#### ■ **DISCLAIMERS:**

- Repair, replace or refund OF THE Products SHALL CONSTITUTE THE SOLE AND EXCLUSIVE REMEDY FOR THE PRODUCTS. WE EXPRESSLY EXCLUDE ALL EXPRESS WARRANTIES IN RELATION TO THE PRODUCTS INCLUDING THE IMPLIED WARRANTIES OF MERCHANTABILITY AND FITNESS FOR A PARTICULAR PURPOSE
- Both parties agree that before your consent to the document, we reserve rights to modify and DISCARD the former version of the DOCUMENT and the consent in this clause including a written consent or beginning an actual performance on DEALINGS.

## Revision History

PU35CL1 V0  
Product Specification

Date	Contents	Writer
2019.12.03	New Version	Anita Chen

## *Smart Lighting* *Amazing Life*

Lextar Electronics Corp. is the leading LED (Light Emitting Diode) maker integrating upper stream epitaxial, middle stream chip, and downstream package, SMT and LED lighting applications. Founded in May, 2008, Lextar is a subsidiary of AU Optronics, the leading TFT-LCD and solar PV manufacturer. Lextar's product applications include lighting and LCD backlight. Lextar's manufacturing sites include Hsinchu and Chunan in Taiwan, and Suzhou in China. The company turnover in 2012 is 340 million USD.

单击下面可查看定价，库存，交付和生命周期等信息

[>>Lextar\(隆达\)](#)