

DESCRIPTION

The LTP33xx family of low-dropout (LDO), low-power linear regulators offers very high power supply rejection ratio (PSRR) while maintaining very low 40 μ A ground current, suitable for RF applications. The family uses an advanced CMOS process and a P-MOSFET pass device to achieve fast start-up, very low noise, excellent transient response, and excellent PSRR performance. The LTP33xx is stable with a 1.0 μ F ceramic output capacitor, and uses a precision voltage reference and feedback loop to achieve a worst-case accuracy of 2% over all load, line, process, and temperature variations. It is fully specified from $T_J = -40^\circ\text{C}$ to $+125^\circ\text{C}$, and is offered in a tiny DFN1 \times 1-4L/UTDFN1.0 \times 1.0-4L and SOT23-5L/SC70-5L, and SOT23-3L/SOT-89 packages, which are ideal for small form factor portable equipments such as wireless handsets and wearables.

The LTP33xx is available in standard fixed output voltages of 1.1V, 1.2V, 1.5V, 1.8V, 2.5V, 2.8V, 3.0V, 3.3V, 3.6V and custom voltage options (50mV step options between 0.8V and 5.0V are available upon request).

FEATURES

- Wide Input Voltage Range: 2.5 V to 6.0 V
- Up to 300 mA Load Current
- Standard Fixed Output Voltage Options: 1.1 V, 1.2 V, 1.5 V, 1.8 V, 2.5 V, 2.8 V, 3.0 V, 3.3 V and 3.6 V
- More Output Voltage Options Available on Request
- Ultra Low Dropout: 190 mV at 300 mA Load
- Ultra Low Noise: 45 μ V_{RMS} at 1.2 V output
- Ultra-Fast Start-Up Time: 25 μ s
- Excellent Load and Line Transient Response
- Line Regulation: 0.03% Typically
- With Auto Discharge
- Shutdown Version Available in DFN1 \times 1-4L, UTDFN1.0 \times 1.0-4L, SOT23-5L and SC70-5L Packages
- Normal Version Available in SOT23-3L and SOT-89 Packages

APPLICATIONS

- Smart Phones and Cellular Phones
- Modems
- Security and Surveillance
- Portable Devices
- Battery-Powered Equipments

ORDER INFORMATION

Model ^{Note1}	Package	Ordering Number ^{Note1}	Packing Option
LTP33xx	DFN1×1-4L	LTP33xxNXF4	Tape and Reel, 10000
	SOT23-5L	LTP33xxNXT5	Tape and Reel, 3000
	SC70-5L	LTP33xxNXC5	Tape and Reel, 3000
	UTDFN1.0×1.0-4L	LTP33xxNXFU4	Tape and Reel, 10000
	SOT23-3L	LTP33xxXT3	Tape and Reel, 3000
	SOT-89	LTP33xxXT4	Tape and Reel, 1000

Note1: xx stands for output voltage, e.g. if xx = 18, the output voltage is 1.8V; if xx = 30, the output voltage is 3.0V.
The device with suffix "N" is shutdown version with enable control input.

PIN CONFIGURATION

Shutdown Version With Enable (Top View)

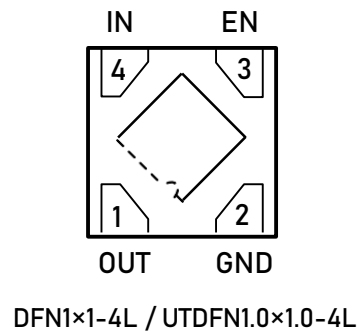
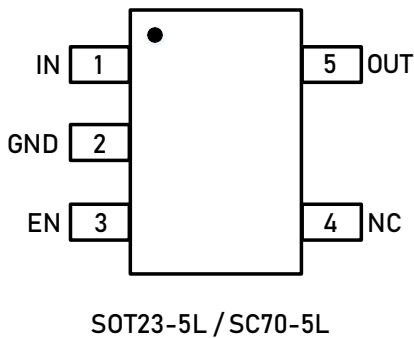

Normal Version Without Enable (Top View)

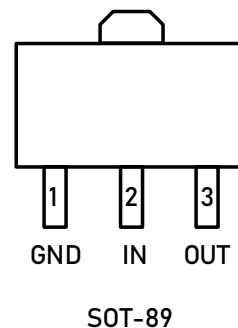
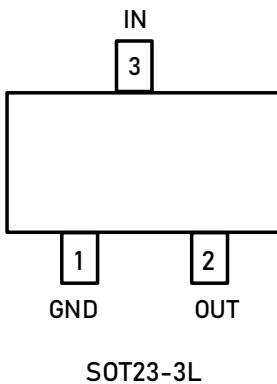

PIN FUNCTION

Pin Number				Pin Name	Function
SOT23-5L SC70-5L	DFN1×1-4L UTDFN1.0×1.0-4L	SOT23-3L	SOT-89		
1	4	3	2	IN	Supply input pin. Must be closely decoupled to GND with a 1μF or greater ceramic capacitor.
2	2	1	1	GND	Ground.
3	3			EN	Enable control input, active high. Do not leave EN floating.
4				NC	No connection.
5	1	2	3	OUT	Output pin. Bypass a 1μF ceramic capacitor from this pin to ground.

BLOCK DIAGRAM

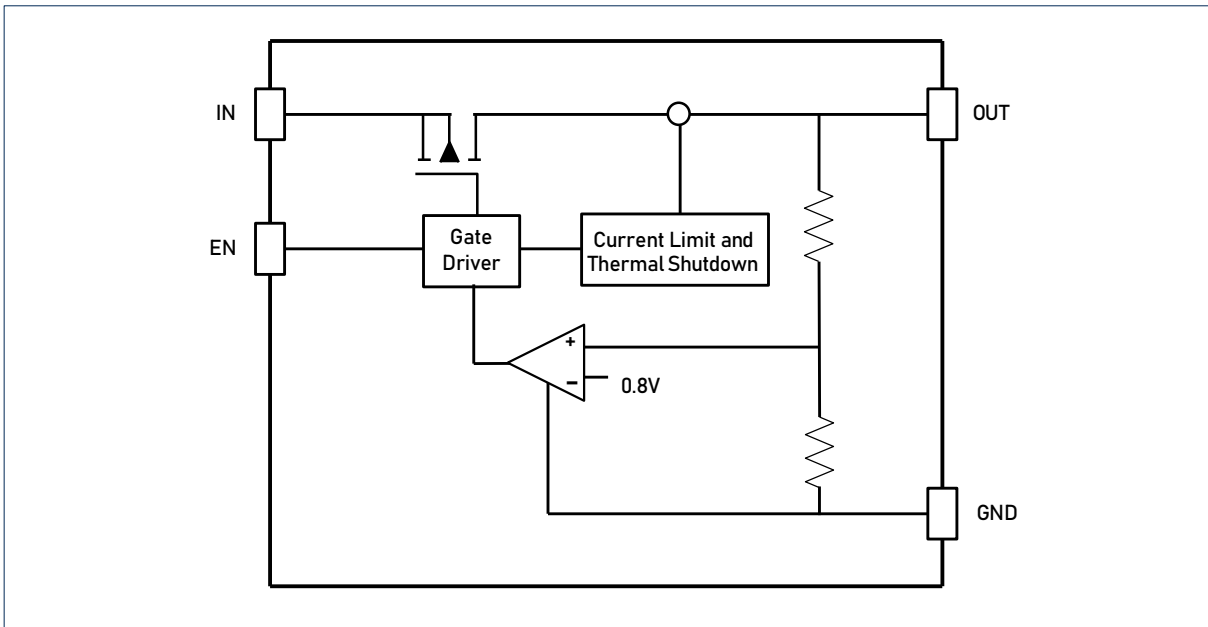

CAUTION: These devices are sensitive to electrostatic discharge; follow proper IC Handling Procedures.

Linearin and designs are registered trademarks of Linearin Technology Corporation.

© Copyright Linearin Technology Corporation. All Rights Reserved.

All other trademarks mentioned are the property of their respective owners. Downloaded From Oneyac.com

FUNCTIONAL DESCRIPTION

Input Capacitor

A 1 μF ceramic capacitor is recommended to connect between IN and GND pins to decouple input power supply glitch and noise. The amount of the capacitance may be increased without limit. This input capacitor must be located as close as possible to the device to assure input stability and less noise. For PCB layout, a wide copper trace is required for both IN and GND.

Output Capacitor

An output capacitor is required for the stability of the LDO. The recommended output capacitance is from 1 μF to 2.2 μF , Equivalent Series Resistance (ESR) is from 5 m Ω to 100 m Ω , and temperature characteristics is X7R or X5R. Higher capacitance values help to improve load/line transient response. The output capacitance may be increased to keep low undershoot/overshoot. Place output capacitor as close as possible to OUT and GND pins.

ON/OFF Input Operation

The LTP33xx is turned on by setting the EN pin high, and is turned off by pulling it low. If this feature is not used, the EN pin should be tied to IN pin to keep the regulator output on at all time.

High PSRR and Low Noise

RF circuits such as LNA (low-noise amplifier), up/down-converter, mixer, PLL, VCO, and IF stage, require low noise and high PSRR LDOs. The temperature-compensated crystal oscillator circuit requires very high PSRR at RF power amplifier burst frequency. For instance, minimum 65 dB PSRR at 217 Hz is recommended for the GSM handsets.

In order to provide good audio quality, the audio power supply for hand-free, game, MP3, and multimedia applications in cellular phones, require low-noise and high PSRR at audio frequency range (20 Hz to 20 kHz).

The LTP33xx, with PSRR of 70 dB at 1 kHz, is suitable for most of these applications that require high PSRR and low noise.

Ultra Fast Start-up

After enabled, the LTP33xx is able to provide full power in as little as tens of microseconds, typically 25 μs . This feature will help load circuitry move in and out of standby mode in real time, eventually extend battery life for mobile phones and other portable devices.

Fast Transient Response

Fast transient response LDOs can also extend battery life. TDMA-based cell phone protocols such as Global System for Mobile Communications (GSM) have a transmit/receive duty factor of only 12.5 percent, enabling power savings by putting much of the baseband circuitry into standby mode in between transmit cycles. In baseband circuits, the load often transitions virtually instantaneously from 100 μA to 100 mA. To meet this load requirement, the LDO must react very quickly without a large voltage drop or overshoot — a requirement that cannot be met with conventional, general-purpose LDOs.

The LTP33xx's fast transient response from 0 to 300 mA provides stable voltage supply for fast DSP and GSM chipset with fast changing load.

Low Quiescent Current

Cellular phone baseband internal digital circuits typically operate all the time. That requires LDO stays on at all times. However, in the standby mode, the microprocessor consumes only around 100 ~ 300 μ A. Since the phone stays in standby for the longest percentage of time, using a 40 μ A quiescent current LDO, instead of 100 μ A, saves 60 μ A and can substantially extends the battery standby time.

The LTP33xx, consuming only around 40 μ A for all input range and output loading, provides great power saving in portable and low power applications.

Current Limit Protection

When output current at the OUT pin is higher than current limit threshold or the OUT pin, the current limit protection will be triggered and clamp the output current to approximately 500 mA to prevent over-current and to protect the regulator from damage due to overheating.

Thermal Shutdown Protection

Thermal protection disables the output when the junction temperature rises to approximately +155° C, allowing the device to cool down. When the junction temperature reduces to approximately +130° C the output circuitry is enabled again. Depending on power dissipation, thermal resistance, and ambient temperature, the thermal protection circuit may cycle on and off. This cycling limits the heat dissipation of the regulator, protecting it from damage due to overheating.

FUNCTIONAL DESCRIPTION

Parameter	Rating	Unit
IN Voltage	-0.3 to 6.5	V
Other Pin Voltage	-0.3 to $V_{IN} + 0.3$	V
Maximum Load Current	500	mA
Junction to Ambient Thermal Resistance (θ_{JA}), SOT23-5	220	°C/W
Operating Junction Temperature	-40 to 125	°C
Storage Temperature	-65 to 150	°C
Lead Temperature (Soldering, 10 sec)	300	°C

NOTE: Stresses beyond those listed under "Absolute Maximum Ratings" may cause permanent damage to the device. These are stress ratings only, and functional operation of the device at these or any other conditions beyond those indicated in the operational sections of the specifications is not implied. Exposure to absolute maximum rating conditions for extended periods may affect device reliability.

CAUTION:

This integrated circuit can be damaged by ESD if you don't pay attention to ESD protection. LINEARIN recommends that all integrated circuits be handled with appropriate precautions. Failure to observe proper handling and installation procedures can cause damage. ESD damage can range from subtle performance degradation to complete device failure. Precision integrated circuits may be more susceptible to damage because very small parametric changes could cause the device not to meet its published specifications.

LINEARIN reserves the right to make any change in circuit design, specification or other related things if necessary without notice at any time. Please contact LINEARIN sales office to get the latest datasheet.

ELECTRICAL CHARACTERISTICS

(V_{IN} = V_{EN} = 3.6 V, T_A = 25 °C unless otherwise noted)

Parameter	Symbol	Test Conditions	Min.	Typ.	Max.	Unit
Input Voltage Operation Range	V _{IN}		2.5		6.0	V
Dropout Voltage	V _{DROP}	V _{OUT} ≥ 2.8 V, I _{OUT} = 300 mA		190	280	mV
DC Supply Quiescent Current	I _{Q_ON}	Active mode: V _{EN} = V _{IN}		40	70	μA
DC Supply Shutdown Current	I _{Q_OFF}	V _{EN} = 0V		0.01	1	μA
Regulated Output Voltage	V _{OUT}	I _{OUT} = 1 mA, -40°C ≤ T _A ≤ 85°C	-2		2	%
Output Voltage Line Regulation		V _{IN} = V _{OUT} + 1 V to 5.5 V, I _{OUT} = 10 mA		0.03	0.2	%
Output Voltage Load Regulation		I _{OUT} from 0 mA to 300 mA		0.1	0.4	%
Soft-start Time		from Enable to Power On		25		μs
Current Limit		R _{LOAD} = 1 Ω	300			mA
Power Supply Rejection Ratio	PSRR	f = 1 kHz, C _{OUT} = 1 μF, I _{OUT} = 20 mA		70		dB
		f = 10 kHz, C _{OUT} = 1 μF, I _{OUT} = 30 mA		52		
Output Noise		10 Hz to 100 kHz, I _{OUT} = 200 mA, V _{OUT} = 2.8 V, C _{OUT} = 1 μF		70		μV _{RMS}
		10 Hz to 100 kHz, I _{OUT} = 200 mA, V _{OUT} = 1.2 V, C _{OUT} = 1 μF		45		
EN Low Threshold					0.4	V
EN High Threshold			1.4			V
EN Pin Input Current	I _{EN}			0	0.1	μA
Over-temperature Shutdown Threshold				155		°C
Over-temperature Shutdown Hysteresis				20		°C

Note: Production test at + 25°C. Specifications over the temperature range are guaranteed by design and characterization.

TYPICAL PERFORMANCE CURVES

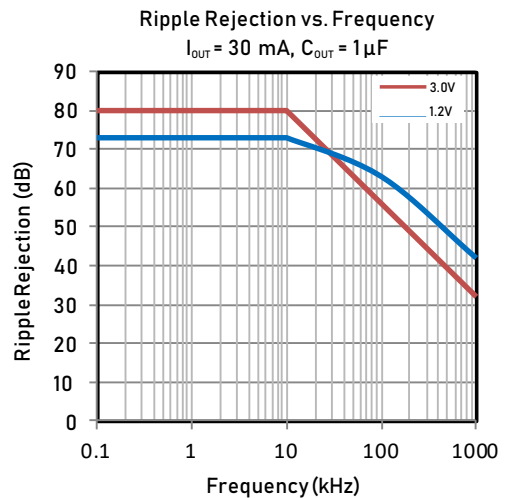
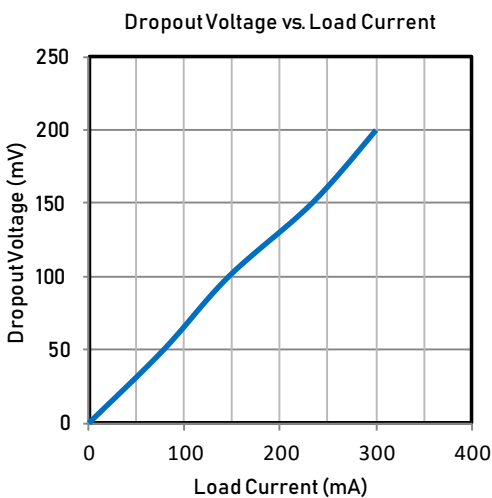
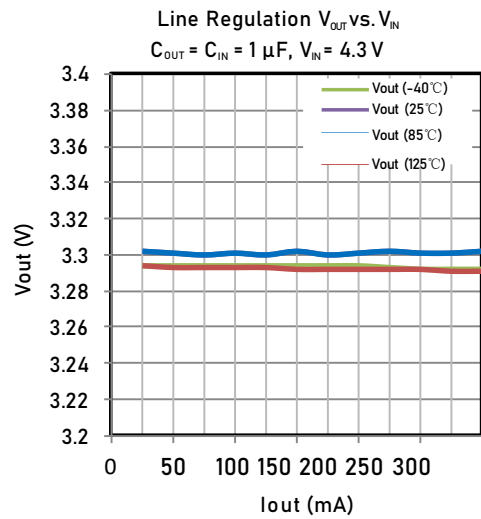
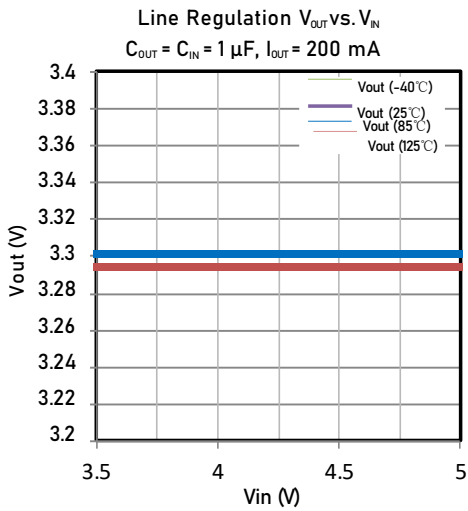
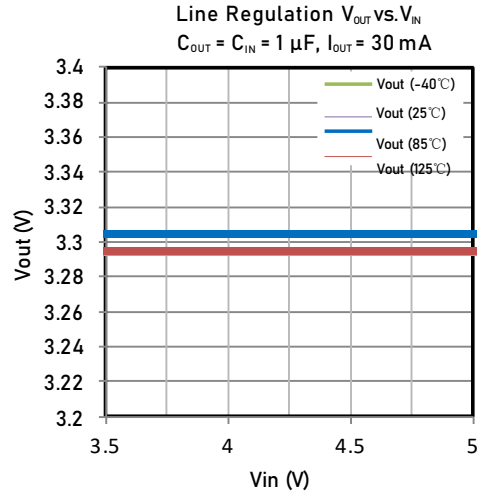
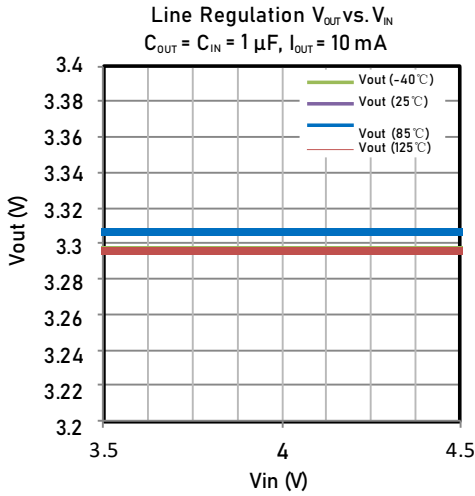

TYPICAL PERFORMANCE CHARACTERISTICS

Load Transient Response

$V_{IN} = 4.2\text{ V}$, $V_{OUT} = 3.3\text{ V}$, $C_{IN} = C_{OUT} = 1\ \mu\text{F}$,
 $I_{OUT} = 10\text{ mA}$ to 310 mA to 10 mA

(Rise/Fall time = 500 ns)

CH1: V_{OUT} , 50 mV/Div, DC Offset = 3.3 V

CH2: I_{OUT} , 100 mA/Div DC

TIME: 10 ms/Div



Load Transient Response

$V_{IN} = 4.2\text{ V}$, $V_{OUT} = 3.3\text{ V}$, $C_{IN} = C_{OUT} = 1\ \mu\text{F}$,
 $I_{OUT} = 10\text{ mA}$ to 160 mA to 10 mA

(Rise/Fall time = 500 ns)

CH1: V_{OUT} , 50 mV/Div, DC Offset = 3.3V

CH2: I_{OUT} , 50 mA/Div DC

TIME: 20 ms/Div

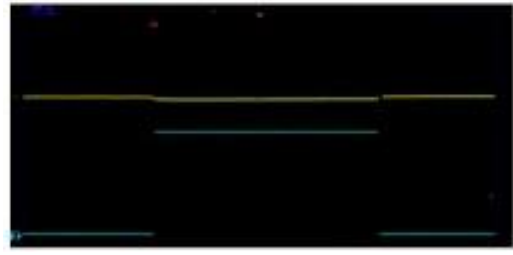

Load Transient Response

$V_{IN} = 4.2\text{ V}$, $V_{OUT} = 3.3\text{ V}$, $C_{IN} = C_{OUT} = 1\ \mu\text{F}$,
 $I_{OUT} = 10\text{ mA}$ to 80 mA to 10 mA

(Rise/Fall time = 500 ns)

CH1: V_{OUT} , 100 mV/Div, DC Offset = 3.3 V

CH2: I_{OUT} , 25 mA/Div DC

TIME: 10ms/Di



Line Transient Response

$V_{IN} = 3.8\text{ V}$ to 4.8 V to 3.8 V

(Rise/Fall time = 500 ns)

$V_{OUT} = 3.3\text{ V}$, $C_{IN} = C_{OUT} = 1\ \mu\text{F}$, $I_{OUT} = 100\text{ mA}$

CH2: V_{OUT} , 20 mV/Div, DC Offset = 3.3 V

CH1: V_{IN} , 2V/Div DC Offset = 3.8 V

TIME: 20 ms/Div



Line Transient Response

$V_{IN} = 3.8\text{ V}$ to 4.8 V to 3.8 V

(Rise/Fall time = 500 ns)

$V_{OUT} = 3.3\text{ V}$, $C_{IN} = C_{OUT} = 1\ \mu\text{F}$, $I_{OUT} = 50\text{ mA}$

CH2: V_{OUT} , 20 mV/Div, DC Offset = 3.3 V

CH1: V_{IN} , 2 V/Div DC Offset = 3.8 V



Line Transient Response

$V_{IN} = 3.8\text{ V}$ to 4.8 V to 3.8 V

(Rise/Fall time = 500 ns)

$V_{OUT} = 3.3\text{ V}$, $C_{IN} = C_{OUT} = 1\ \mu\text{F}$, $I_{OUT} = 10\text{ mA}$

CH2: V_{OUT} , 20 mV/Div, DC Offset = 3.3 V

CH1: V_{IN} , 2 V/Div DC Offset = 3.8 V



Exiting Shutdown

$V_{IN} = 4.2\text{ V}$, $V_{OUT} = 3.3\text{ V}$, $C_{IN} = C_{OUT} = 1\text{ }\mu\text{F}$,

$I_{OUT} = 10\text{ mA}$

CH1: EN, 5 V/Die, DC CH2:

V_{OUT} , 1 V/Die DC

TIME: 40 $\mu\text{s/Div}$

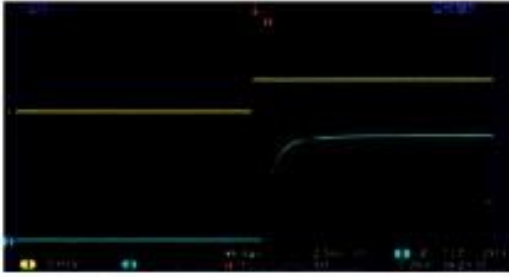

Entering Shutdown

$V_{IN} = 4.2\text{ V}$, $V_{OUT} = 3.3\text{ V}$, $C_{IN} = C_{OUT} = 1\text{ }\mu\text{F}$,

$I_{OUT} = 10\text{ mA}$

CH1: EN, 5 V/Die, DC CH2:

V_{OUT} , 1 V/Die DC

TIME: 40 $\mu\text{s/Div}$

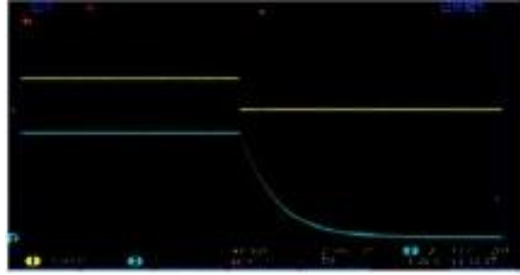

APPLICATION CIRCUITS

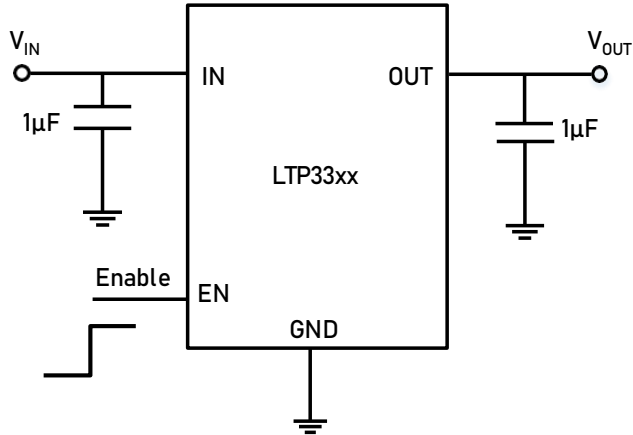

CAUTION: These devices are sensitive to electrostatic discharge; follow proper IC Handling Procedures.

Linearin and designs are registered trademarks of Linearin Technology Corporation.

© Copyright Linearin Technology Corporation. All Rights Reserved.

All other trademarks mentioned are the property of their respective owners. Downloaded From [Oneyac.com](http://www.Oneyac.com)

PACKAGE DIMENSION

UTDFN1.0×1.0-4L

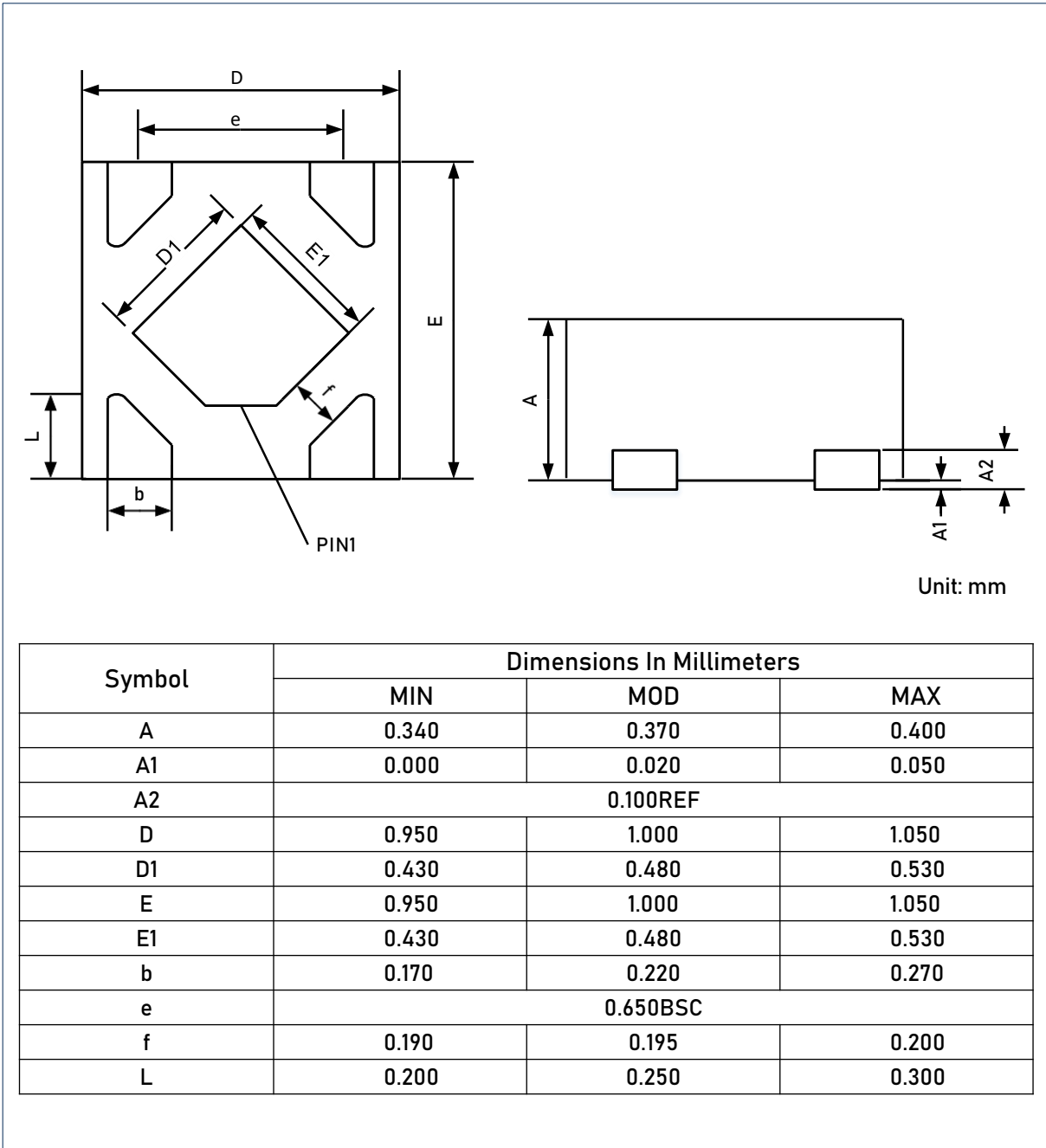

CAUTION: These devices are sensitive to electrostatic discharge; follow proper IC Handling Procedures.

Linearin and designs are registered trademarks of Linearin Technology Corporation.

© Copyright Linearin Technology Corporation. All Rights Reserved.

All other trademarks mentioned are the property of their respective owners. Downloaded From [Oneyac.com](https://www.oneyac.com)

PACKAGE DIMENSION

DFN1.0×1.0-4L

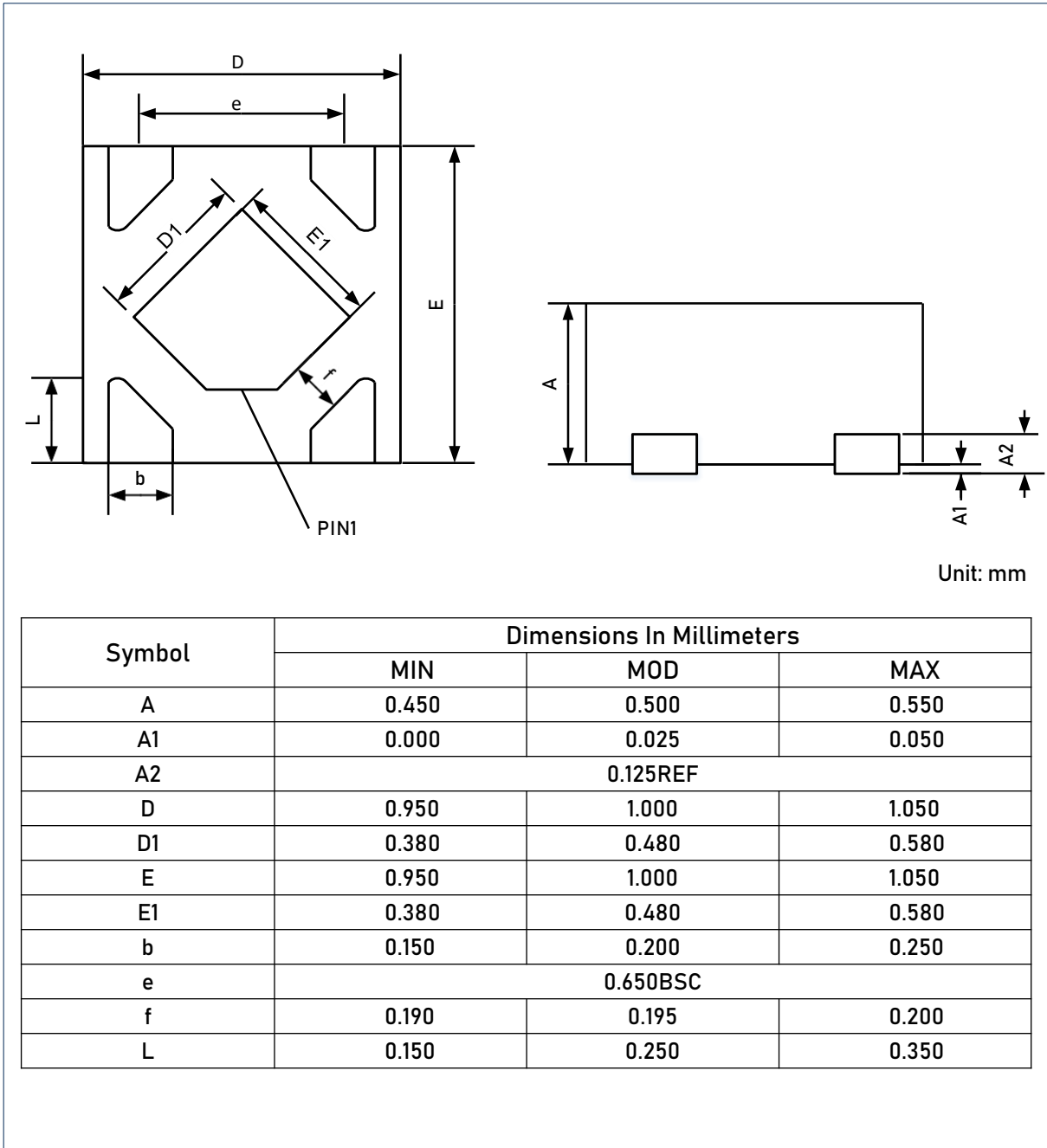

CAUTION: These devices are sensitive to electrostatic discharge; follow proper IC Handling Procedures.

Linearin and designs are registered trademarks of Linearin Technology Corporation.

© Copyright Linearin Technology Corporation. All Rights Reserved.

All other trademarks mentioned are the property of their respective owners. Downloaded From [Oneyac.com](http://www.Oneyac.com)

PACKAGE DIMENSION

SC70-5L

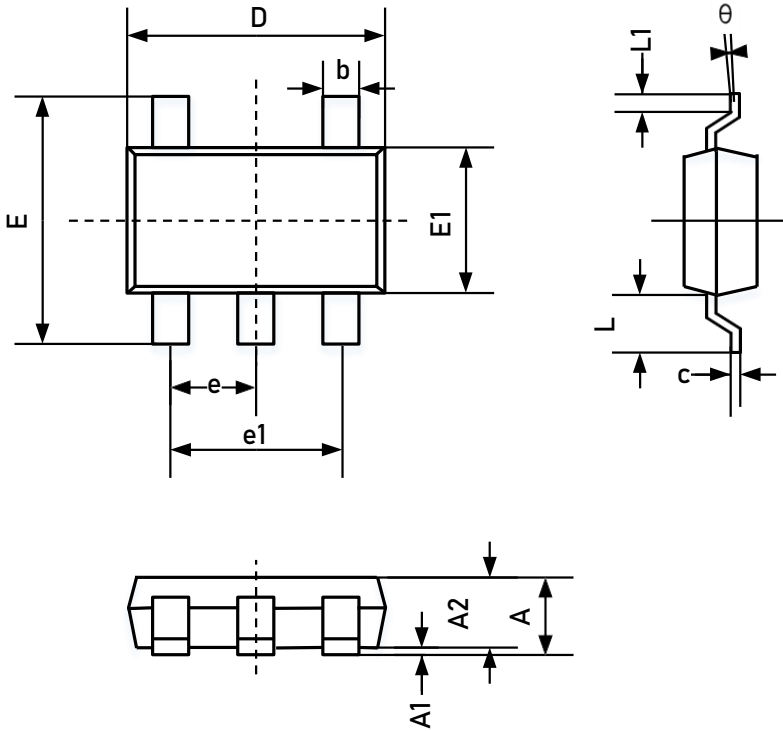

Unit: mm

Symbol	Dimensions In Millimeters	
	MIN	MAX
A	0.900	1.100
A1	0.000	0.100
A2	0.900	1.000
b	0.150	0.350
c	0.080	0.150
D	2.000	2.200
E	2.150	2.450
E1	1.150	1.350
e	0.650BSC	
e1	1.200	1.400
L	0.525REF	
L1	0.260	0.460
theta	0°	8°

CAUTION: These devices are sensitive to electrostatic discharge; follow proper IC Handling Procedures.

Linearin and designs are registered trademarks of Linearin Technology Corporation.

© Copyright Linearin Technology Corporation. All Rights Reserved.

All other trademarks mentioned are the property of their respective owners. Downloaded From [Onyac.com](https://www.onyac.com)

PACKAGE DIMENSION

SOT23-3L

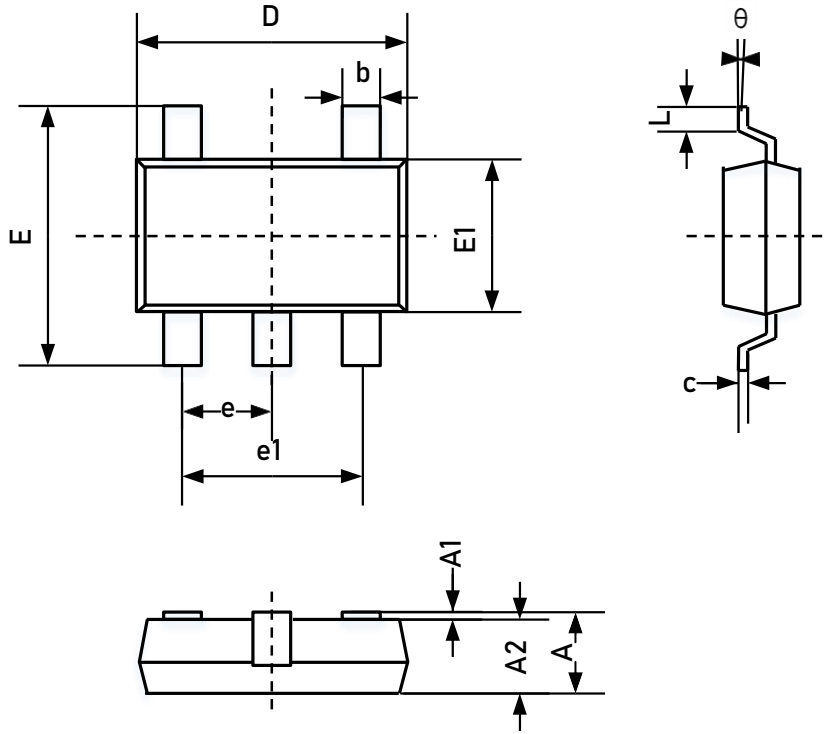

Unit: mm

Symbol	Dimensions In Millimeters	
	MIN	MAX
A	1.050	1.250
A1	0.000	0.100
A2	1.000	1.150
b	0.300	0.400
c	0.100	0.200
D	2.820	3.020
E	2.650	2.950
E1	1.500	1.700
e	0.950BSC	
e1	1.800	2.000
L	0.300	0.600
θ	0°	8°

PACKAGE DIMENSION

SOT23-5L

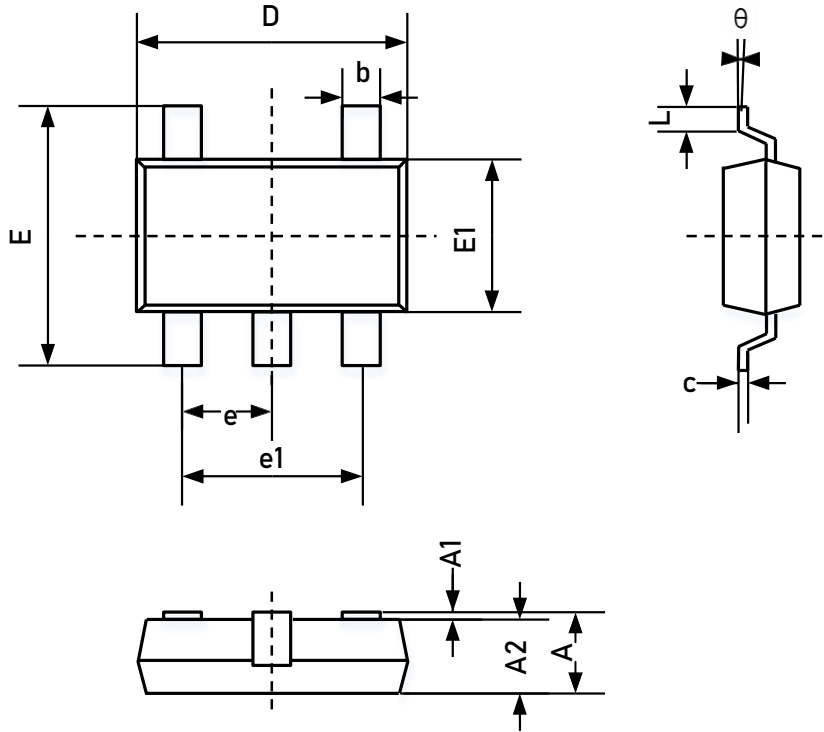

Unit: mm

Symbol	Dimensions In Millimeters	
	MIN	MAX
A	0.700	1.250
A1	0.000	0.100
A2	1.050	1.150
b	0.350	0.500
c	0.080	0.200
D	2.820	3.020
E	2.650	2.950
E1	1.600	1.700
e	0.950BSC	
E1	1.800	2.000
L	0.300	0.600
θ	0°	8°

PACKAGE DIMENSION

SOT-89

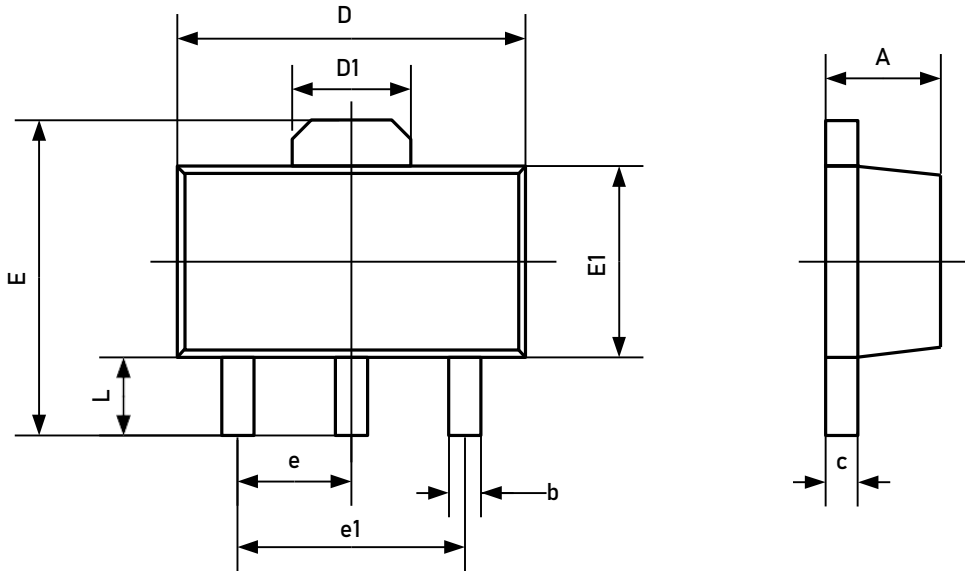

Unit: mm

Symbol	Dimensions In Millimeters	
	MIN	MAX
A	1.400	1.600
b	0.320	0.520
c	0.350	0.440
D	4.400	4.600
D1	1.55REF	
E	3.940	4.250
E1	2.300	2.600
e	1.500BSC	
e1	3.000BSC	
L	0.900	1.200

CAUTION: These devices are sensitive to electrostatic discharge; follow proper IC Handling Procedures.

Linearin and designs are registered trademarks of Linearin Technology Corporation.

© Copyright Linearin Technology Corporation. All Rights Reserved.

All other trademarks mentioned are the property of their respective owners. Downloaded From Oneyac.com

单击下面可查看定价，库存，交付和生命周期等信息

[>>Linearin\(先积\)](#)