

Description

The 1.0SMB series is designed specifically to protect sensitive electronic equipment from voltage transients induced by lightning and other transient voltage events. For surface mounted applications in order to optimize board space.

Features

- Halogen free and RoHS compliant
- Low profile package
- Built-in strain relief design
- Low inductance
- Excellent clamping capability
- 1000W peak pulse power capability at 10/1000μs waveform, repetition rate (duty cycle): 0.01%
- Fast response time
- Typical I_R less than 1μA above 12V devices
- Peak 260°C high temperature Reflow Soldering withstanding
- Meet MSL level1, per J-STD-020
- IEC-61000-4-2 ESD 30kV(Air), 30kV (Contact)
- Unit Weight: 0.10g

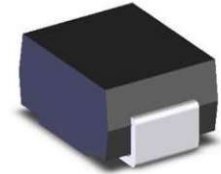

Applications

TVS components are ideal for the protection of I/O Interfaces, VCC bus and other vulnerable circuits used in telecom, computer, Industrial and consumer electronic applications.

Maximum Ratings and Characteristics ($T_A=25^\circ\text{C}$)

Rating	Symbol	Value
Peak pulse power dissipation at 10/1000μs waveform (Note1, Note2, Fig.1)	P_{PPM}	1000W
Peak pulse current of at 10/1000μs waveform (Note 1, Fig.3)	I_{PPM}	See Table(A)
Steady state power dissipation at $T_A=50^\circ\text{C}$ (Fig.5)	$P_{M(AV)}$	5.0W
Maximum Instantaneous Forward Voltage at 50A for Unidirectional Only	V_F	3.5V
Peak forward surge current, 8.3ms single half sine-wave superimposed on rated load, (JEDEC Method) (Note3, Fig.6)	I_{FSM}	100A
Operating junction and Storage Temperature Ranges	T_J, T_{STG}	-55°C to $+150^\circ\text{C}$
Typical thermal resistance junction to lead	$R_{\theta JL}$	20°C/W
Typical thermal resistance junction to ambient	$R_{\theta JA}$	100°C/W

Notes:1. Non-repetitive current pulse, per Fig.3 and derating above $T_A=25^\circ\text{C}$ per Fig.2.

2. Each terminal is surface Mounted on the 5.0mm × 5.0mm (0.03mm thick) copper pads.

3. 8.3ms single half sine-wave or equivalent square wave, duty cycle=4 pulses per minutes maximum.

Electrical Characteristics (T_A=25°C)

Part Number		Device Marking Code		Reverse Stand-Off Voltage	Breakdown Voltage @I _T		Test Current	Maximum Clamping Voltage @I _{PP}	Peak Pulse Current	Reverse Leakage @V _R
Uni.	Bi.	Uni.	Bi.	V _R (V)	V _{B Min.} (V)	V _{B Max.} (V)	I _T (mA)	V _C (V)	I _{PP} (A)	I _R (μA)
1.0SMB6.8A	1.0SMB6.8CA	6V8A •	6V8C •	5.80	6.45	7.14	10	10.5	96.8	1000
1.0SMB7.5A	1.0SMB7.5CA	7V5A •	7V5C •	6.40	7.13	7.88	10	11.3	90.0	500
1.0SMB8.2A	1.0SMB8.2CA	8V2A •	8V2C •	7.02	7.79	8.61	10	12.1	84.0	200
1.0SMB9.1A	1.0SMB9.1CA	9V1A •	9V1C •	7.78	8.65	9.55	1	13.4	75.8	50
1.0SMB10A	1.0SMB10CA	10A •	10C •	8.55	9.50	10.50	1	14.5	70.2	10
1.0SMB11A	1.0SMB11CA	11A •	11C •	9.40	10.50	11.60	1	15.6	65.2	5
1.0SMB12A	1.0SMB12CA	12A •	12C •	10.20	11.40	12.60	1	16.7	60.8	5
1.0SMB13A	1.0SMB13CA	13A •	13C •	11.10	12.40	13.70	1	18.2	55.8	1
1.0SMB15A	1.0SMB15CA	15A •	15C •	12.80	14.30	15.80	1	21.2	48.0	1
1.0SMB16A	1.0SMB16CA	16A •	16C •	13.60	15.20	16.80	1	22.5	45.2	1
1.0SMB18A	1.0SMB18CA	18A •	18C •	15.30	17.10	18.90	1	25.2	40.3	1
1.0SMB20A	1.0SMB20CA	20A •	20C •	17.10	19.00	21.00	1	27.7	36.7	1
1.0SMB22A	1.0SMB22CA	22A •	22C •	18.80	20.90	23.10	1	30.6	33.2	1
1.0SMB24A	1.0SMB24CA	24A •	24C •	20.50	22.80	25.20	1	33.2	30.7	1
1.0SMB27A	1.0SMB27CA	27A •	27C •	23.10	25.70	28.40	1	37.5	27.2	1
1.0SMB30A	1.0SMB30CA	30A •	30C •	25.60	28.50	31.50	1	41.4	24.5	1
1.0SMB33A	1.0SMB33CA	33A •	33C •	28.20	31.40	34.70	1	45.7	22.2	1
1.0SMB36A	1.0SMB36CA	36A •	36C •	30.80	34.20	37.80	1	49.9	20.3	1
1.0SMB39A	1.0SMB39CA	39A •	39C •	33.30	37.10	41.00	1	53.9	18.8	1
1.0SMB43A	1.0SMB43CA	43A •	43C •	36.80	40.90	45.20	1	59.3	17.2	1
1.0SMB47A	1.0SMB47CA	47A •	47C •	40.20	44.70	49.40	1	64.8	15.7	1
1.0SMB51A	1.0SMB51CA	51A •	51C •	43.60	48.50	53.60	1	70.1	14.5	1
1.0SMB56A	1.0SMB56CA	56A •	56C •	47.80	53.20	58.80	1	77.0	13.2	1
1.0SMB62A	1.0SMB62CA	62A •	62C •	53.00	58.90	65.10	1	85.0	12.0	1
1.0SMB68A	1.0SMB68CA	68A •	68C •	58.10	64.60	71.40	1	92.0	11.0	1

Ratings and Characteristic Curves ($T_A=25^\circ\text{C}$)

Figure 1. Peak Pulse Power Rating Curve

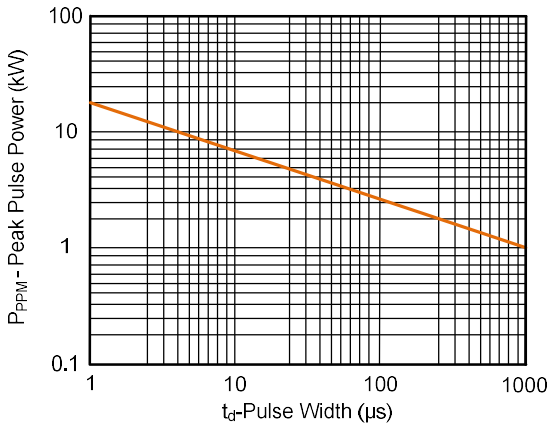

Figure 2. Pulse Derating Curve

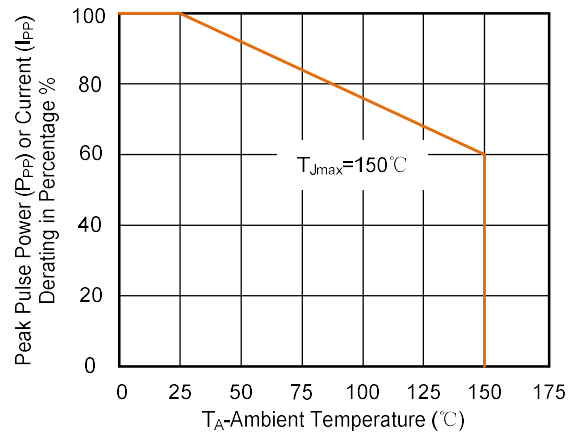

Figure 3. Pulse Waveform

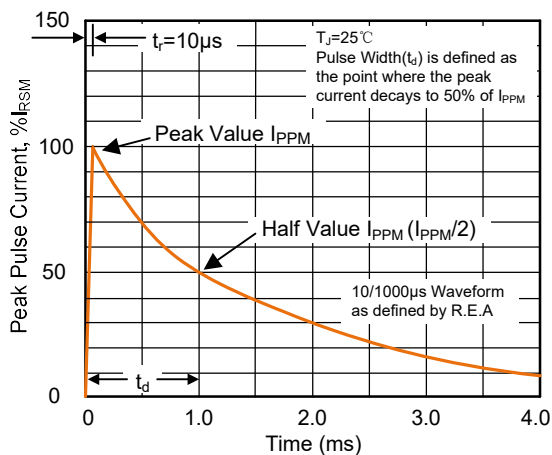

Figure 4. Typical Junction Capacitance

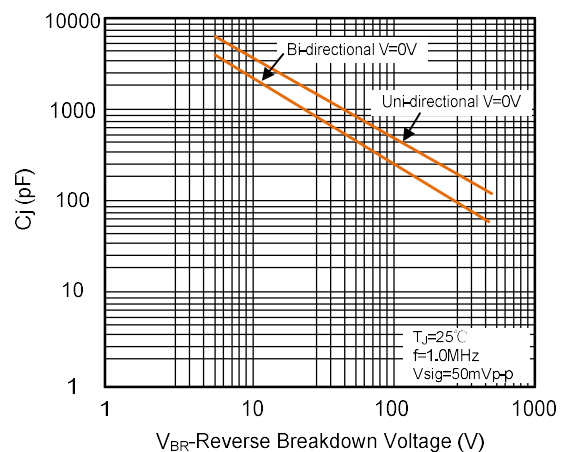

Figure 5. Steady State Power Dissipation Derating Curve

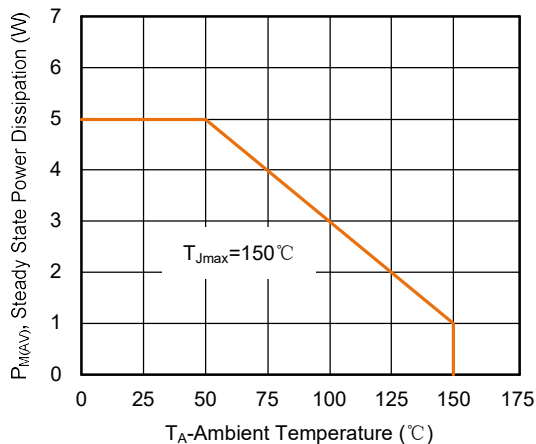
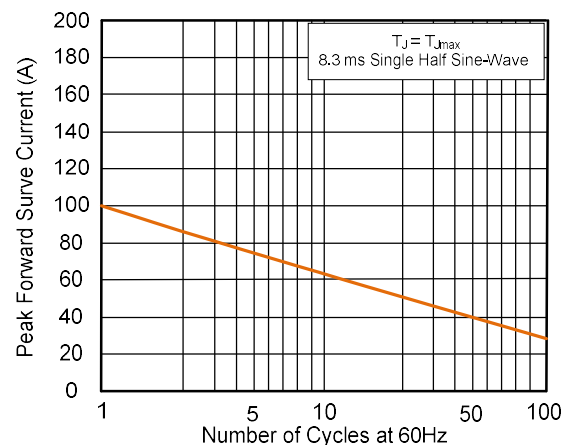
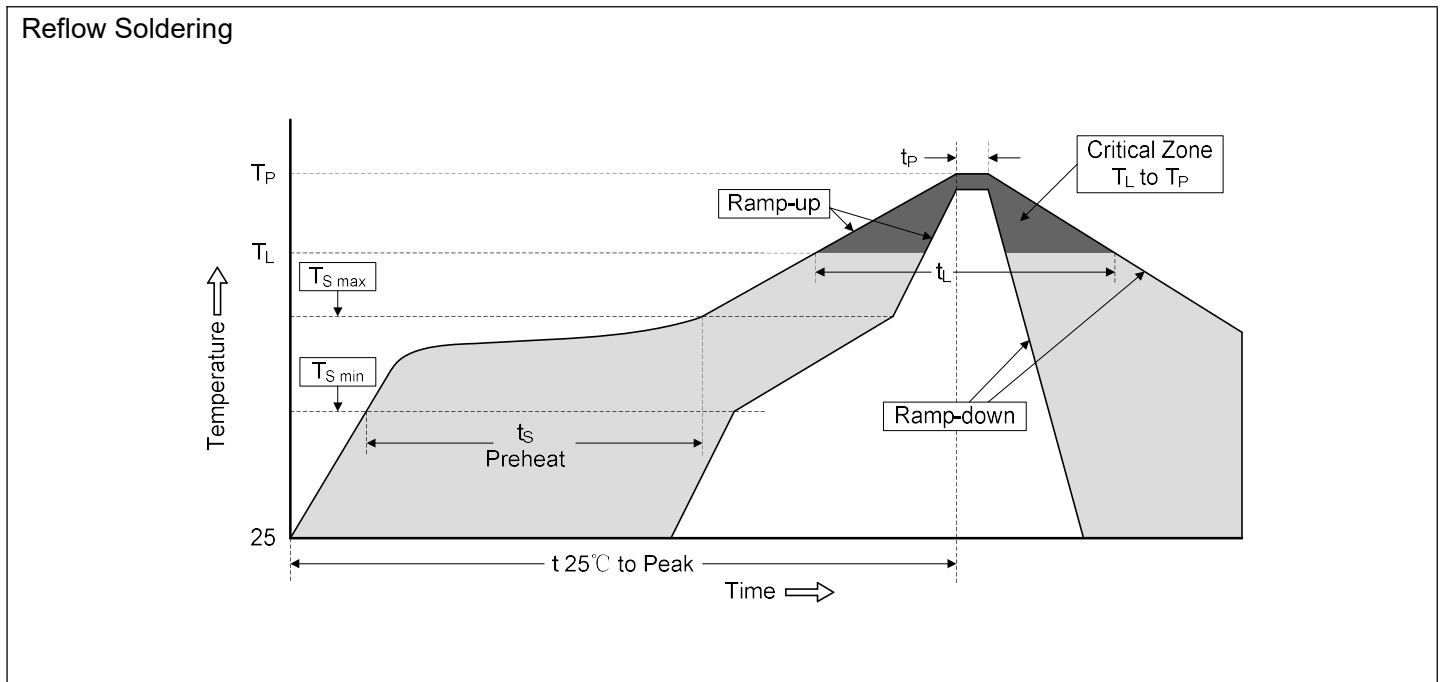

Figure 6. Maximum Non-Repetitive Forward Surge Current Uni-Directional Only



Soldering Parameters



Profile Feature	Pb-Free Assembly
Average ramp-up rate (T_L to T_P)	3°C/second max.
Preheat -Temperature Min ($T_{S\ min}$) -Temperature Max ($T_{S\ max}$) -Time (min to max) (t_s)	150°C 200°C 60-180 seconds
$T_{S\ max}$ to T_L -Ramp-up Rate	3°C/second max.
Time maintained above: -Temperature (T_L) -Time (t_L)	217°C 60-150 seconds
Peak Temperature (T_P)	260°C
Time within 5°C of actual Peak Temperature (t_p)	20-40 seconds
Ramp-down Rate	6°C/second max.
Time 25°C to Peak Temperature	8 minutes max.

Part Number Code and Marking Code

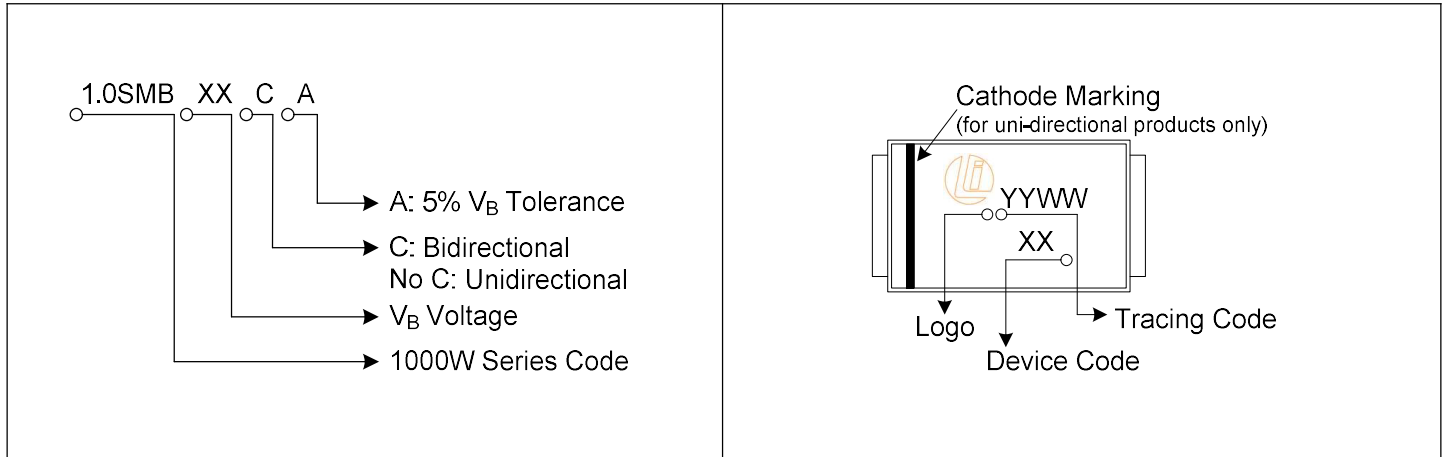

Dimensions (SMB/DO-214AA)

Symbol	Millimeters		Inches	
	Min.	Max.	Min.	Max.
A	1.930	2.200	0.076	0.086
B	4.060	4.750	0.160	0.187
C	3.300	3.940	0.130	0.155
D	2.160	2.650	0.085	0.104
E	0.760	1.520	0.030	0.060
F	-	0.203	-	0.008
G	5.210	5.590	0.205	0.220
H	0.152	0.305	0.006	0.012
I	2.260	-	0.089	-
J	2.160	-	0.085	-
K	-	2.740	-	0.107

Packaging Specification

Tape

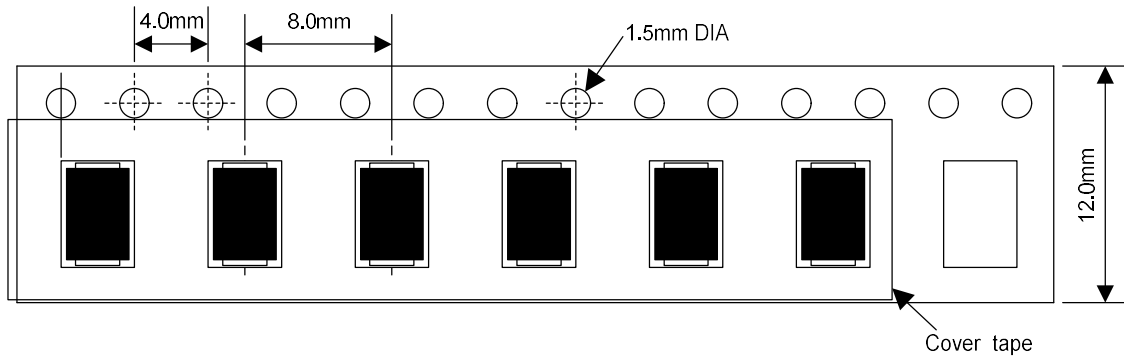

For Uni-Devices

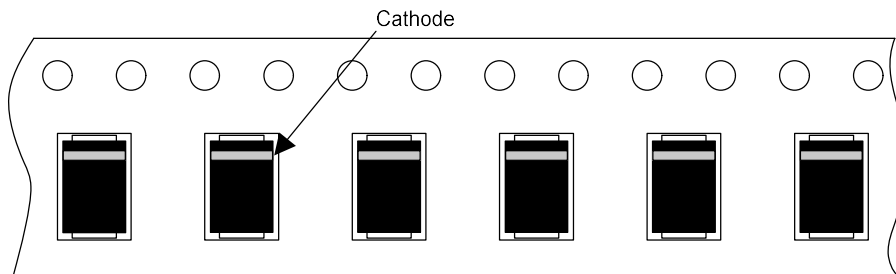

13 Inches Reel

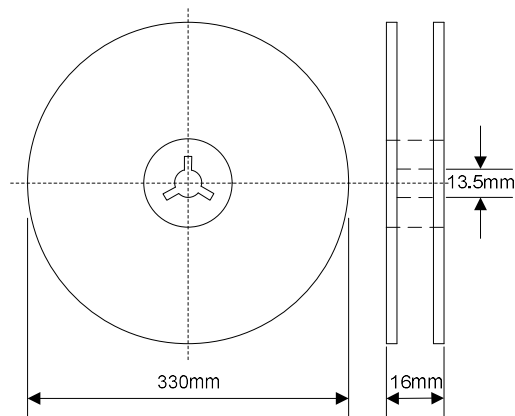

Quantity: 3000pcs/reel

单击下面可查看定价，库存，交付和生命周期等信息

[>>Liown\(里阳半导体\)](#)