

Features

- Approximately zero leaking current before clamping voltage
- Less decay at on/off state
- High capability to withstand repeated lightning strikes
- Low electrode capacitance($\leq 0.8\text{pF}$) and high isolation($\geq 100\text{M}\Omega$)
- Bilateral symmetrical
- Temperature, humidity and lightness insensitive
- RoHS compliant
- Meets MSL level 1, per J-STD-020
- Operating temperature: $-40^{\circ}\text{C} \sim +85^{\circ}\text{C}$
- Storage temperature: $-40^{\circ}\text{C} \sim +125^{\circ}\text{C}$



Applications

- Power Supplies
- Motor sparks eliminating
- Relay switching spark absorbing
- Data line pulse guarding
- Telephone/Fax/Modem
- High frequency signal transmitters/receivers
- Satellite antenna
- Radio amplifiers
- Alarm systems
- Cathode ray tubes in Monitors/TVs

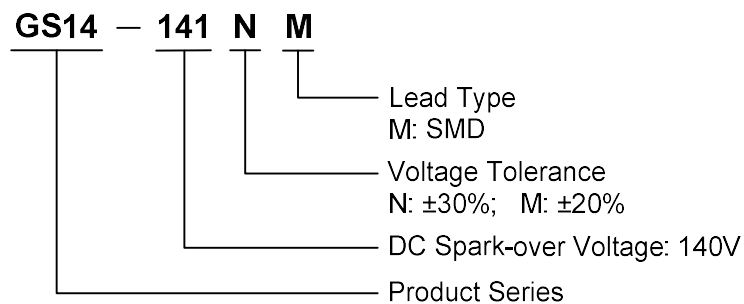
Part Number Code

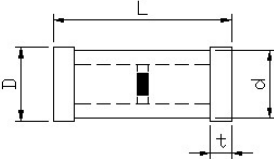

Dimensions

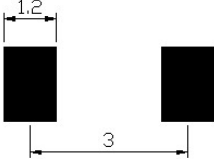
Recommended Pad Layout		Symbol	Dimensions(mm)
		L	3.4 ± 0.5
		D	1.4 ± 0.5
		d	1.3 ± 0.5
		t	0.4 ± 0.2

Electrical Characteristics (T_A=25°C)

Part Number	DC Spark-over Voltage	Minimum Insulation Resistance		Maximum Capacitance (1KHz-6V _{MAX})	Surge Current Capacity
	V _s	Test Voltage	I _{ROHM}	C	@8/20μs
GS14-141NM	140V±30%	50V	100MΩ	0.8pF	300A
GS14-201MM	200V±20%	100V	100MΩ	0.8pF	300A
GS14-301MM	300V±20%	100V	100MΩ	0.8pF	300A

Test Methods and Results

Items	Test Method	Standard
DC Spark-over Voltage	the DC spark-over voltage ascend up within 500V/s. Test current is 0.5mA max.	Meet specified value
Minimum Insulation Resistance	across the terminal at regular voltage. But the test voltage doesn't over the DC spark-over voltage.	Meet specified value
Maximum Capacitance	by applying a voltage of less than 6V (at 1KHz) between terminals.	Meet specified value
Surge Current Capacity	1.2/50μs & 8/20μs,300A, ±5 times, interval 60s.	No crack and no failures
Cold Resistance	-40±3°C(1000hrs) / room temp., normal humidity(4hrs) , measure the properties.	Features are conformed to rated spec.
Heat Resistance	125±2°C(1000hrs) / room temp., normal humidity(4hrs) , measure the properties.	Features are conformed to rated spec.
Humidity Resistance	After 85±2°C, 85% RH (1000hrs)/room temp., normal humidity(4hrs) cycle, measure the properties.	Features are conformed to rated spec.
Temperature Cycle	25 times repetition of cycle -40±3°C(30Min.), room temp., (4 Min.), 125±2°C(30 Min.), room temp., normal humidity (4hrs) .	Features are conformed to rated spec.

Recommended Soldering Conditions

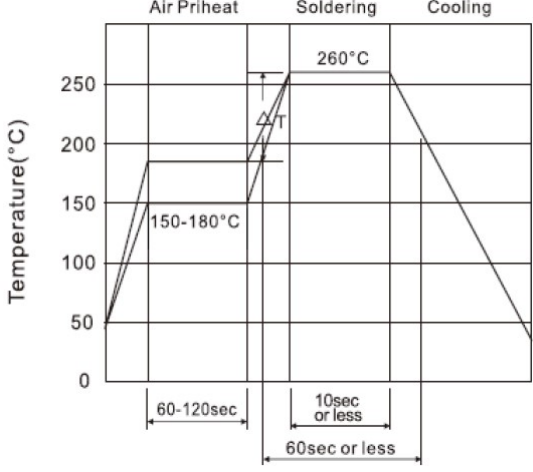
Reflow Soldering	Hand Soldering
 <p>The graph shows a temperature profile for reflow soldering. The y-axis is Temperature (°C) from 0 to 250. The x-axis is time. The profile is divided into three phases: Air Preheat (60-120sec), Soldering (10sec or less), and Cooling (60sec or less). The temperature rises to 150-180°C during preheat, then to 260°C during soldering. A temperature difference ΔT is indicated between the preheat and soldering phases.</p>	<p>Solder iron temperature: 350±5°C Heating time: 3 seconds max.</p> <p>General attention to soldering</p> <ul style="list-style-type: none"> • High soldering temperatures and long soldering times can cause leaching of the termination, decrease in adherence strength, and the change of characteristic may occur. • For soldering, please refer to the soldering curves above. However, please keep exposures to temperatures exceeding 200°C to fewer than 50 seconds. • Please use a mild flux (containing less than 0.2wt% Cl). Also, if the flux is water soluble, be sure to wash thoroughly to remove any residue from the underside of components that could affect resistance.
<p>1) Time shown in the above figures is measured from the point when chip surface reaches temperature. 2) Temperature difference in high temperature part should be within 110°C. 3) After soldering, do not force cool, allow the parts to cool gradually.</p>	
<p>Cleaning</p> <p>When using ultrasonic cleaning, the board may resonate if the output power is too high. Since this vibration can cause cracking or a decrease in the adherence of the termination, we recommend that you use the conditions below.</p> <p>Frequency: 40kHz max. Output power: 20W/liter Cleaning time: 5 minutes max.</p>	

Packaging Specification

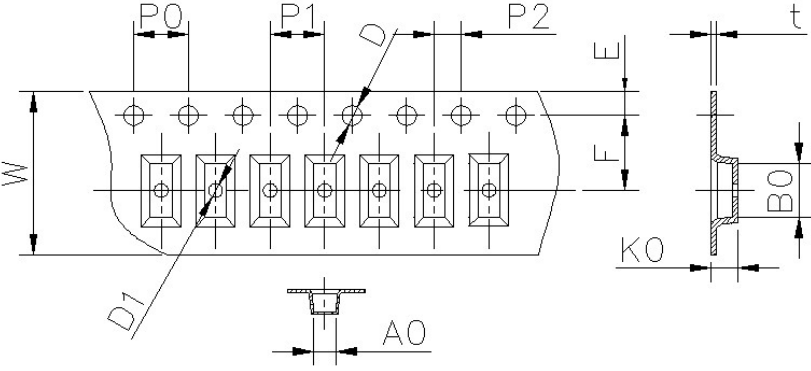
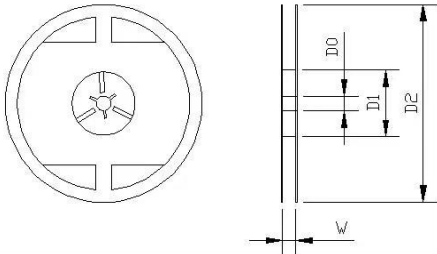
Tape		Symbol		Dimension (mm)			
		W	8.0±0.2	P0	4.0±0.2		
		P1	4.0±0.1	P2	2.0±0.1		
		D	Φ1.55±0.1	D1	Φ1.0±0.1		
		E	1.75±0.1	F	3.5±0.1		
		A0	1.6±0.1	B0	4.0±0.1		
		K0	1.6±0.1	t	0.2±0.1		
		<p data-bbox="87 1131 151 1160">Reel</p> 		D0	13.0±1.0	D1	60.0±1.0
				D2	178.0±2.0	W	8.5±0.2
				Quantity: 3000pcs			

单击下面可查看定价，库存，交付和生命周期等信息

[>>Liown\(里阳半导体\)](#)