

Description

The 5KP series is designed specifically to protect sensitive electronic equipment from voltage transients induced by lightning and other transient voltage events.

Features

- Halogen free and RoHS compliant
- Glass passivated junction
- Low incremental surge resistance
- Excellent clamping capability
- 5000W peak pulse power capability at 10/1000 μ s waveform, repetition rate (duty cycle): 0.05%
- Fast response time
- Typical I_R less than 2 μ A above 10V devices
- High Temperature soldering guaranteed: 265 $^{\circ}$ C/10 seconds/.375", (9.5mm) lead length, 5lbs (2.3kg) tension
- Plastic package has underwriters laboratory flammability 94V-0
- Meet MSL level1, per J-STD-020
- IEC-61000-4-2 ESD 30kV(Air), 30kV (Contact)
- Unit Weight: 2.1g



Applications

TVS components are ideal for the protection of I/O Interfaces, VCC bus and other vulnerable circuits used in telecom, computer, Industrial and consumer electronic applications.

Maximum Ratings and Characteristics ($T_A=25^{\circ}$ C)

Rating	Symbol	Value
Peak pulse power dissipation at 10/1000 μ s waveform (Note1, Fig.1)	P_{PPM}	5000W
Peak pulse current of at 10/1000 μ s waveform (Note 1, Fig.3)	I_{PPM}	See Table(A)
Steady state power dissipation at $T_L=75^{\circ}$ C (Fig.5)	$P_{M(AV)}$	8.0W
Peak forward surge current, 8.3ms single half sine-wave superimposed on rated load, (JEDEC Method) (Note2, Fig.6)	I_{FSM}	400A
Operating junction and Storage Temperature Ranges	T_J, T_{STG}	-55 $^{\circ}$ C to +150 $^{\circ}$ C
Typical thermal resistance junction to lead	$R_{\theta JL}$	8 $^{\circ}$ C/W
Typical thermal resistance junction to ambient	$R_{\theta JA}$	40 $^{\circ}$ C/W

Notes:1. Non-repetitive current pulse, per Fig.3 and derating above $T_A=25^{\circ}$ C per Fig.2.

2. 8.3ms single half sine-wave or equivalent square wave, duty cycle=4 pulses per minutes maximum.

Electrical Characteristics (T_A=25°C)

Part Number		Reverse Stand-Off Voltage	Breakdown Voltage @I _T		Test Current	Maximum Clamping Voltage @I _{PP}	Peak Pulse Current	Reverse Leakage @V _R
Uni.	Bi.	V _R (V)	V _{B Min.} (V)	V _{B Max.} (V)	I _T (mA)	V _C (V)	I _{PP} (A)	I _R (μA)
5KP5.0A	5KP5.0CA	5.0	6.40	7.00	50	9.2	554.3	3000
5KP6.0A	5KP6.0CA	6.0	6.67	7.37	50	10.3	495.1	2000
5KP6.5A	5KP6.5CA	6.5	7.22	7.98	50	11.2	455.4	1000
5KP7.0A	5KP7.0CA	7.0	7.78	8.60	50	12.0	425.0	800
5KP7.5A	5KP7.5CA	7.5	8.33	9.21	5	12.9	395.3	250
5KP8.0A	5KP8.0CA	8.0	8.89	9.83	5	13.6	375.0	150
5KP8.5A	5KP8.5CA	8.5	9.44	10.40	5	14.4	354.2	50
5KP9.0A	5KP9.0CA	9.0	10.00	11.10	5	15.4	331.2	20
5KP10A	5KP10CA	10.0	11.10	12.30	5	17.0	300.0	10
5KP11A	5KP11CA	11.0	12.20	13.50	5	18.2	280.2	2
5KP12A	5KP12CA	12.0	13.30	14.70	5	19.9	256.3	2
5KP13A	5KP13CA	13.0	14.40	15.90	5	21.5	237.2	2
5KP14A	5KP14CA	14.0	15.60	17.20	5	23.2	219.8	2
5KP15A	5KP15CA	15.0	16.70	18.50	5	24.4	209.0	2
5KP16A	5KP16CA	16.0	17.80	19.70	5	26.0	196.2	2
5KP17A	5KP17CA	17.0	18.90	20.90	5	27.6	184.8	2
5KP18A	5KP18CA	18.0	20.00	22.10	5	29.2	174.7	2
5KP20A	5KP20CA	20.0	22.20	24.50	5	32.4	157.4	2
5KP22A	5KP22CA	22.0	24.40	26.90	5	35.5	143.7	2
5KP24A	5KP24CA	24.0	26.70	29.50	5	38.9	131.1	2
5KP26A	5KP26CA	26.0	28.90	28.90	5	42.1	121.1	2
5KP28A	5KP28CA	28.0	31.10	34.40	5	45.4	112.3	2
5KP30A	5KP30CA	30.0	33.30	36.80	5	48.4	105.4	2
5KP33A	5KP33CA	33.0	36.70	40.60	5	53.3	95.7	2
5KP36A	5KP36CA	36.0	40.00	44.20	5	58.1	87.8	2
5KP40A	5KP40CA	40.0	44.40	49.10	5	64.5	79.1	2

Electrical Characteristics (T_A=25°C)

Part Number		Reverse Stand-Off Voltage	Breakdown Voltage @I _T		Test Current	Maximum Clamping Voltage @I _{PP}	Peak Pulse Current	Reverse Leakage @V _R
Uni.	Bi.	V _R (V)	V _{B Min.} (V)	V _{B Max.} (V)	I _T (mA)	V _C (V)	I _{PP} (A)	I _R (μA)
5KP43A	5KP43CA	43.0	47.80	52.80	5	69.4	73.5	2
5KP45A	5KP45CA	45.0	50.00	55.30	5	72.7	70.2	2
5KP48A	5KP48CA	48.0	53.30	58.90	5	77.4	65.9	2
5KP51A	5KP51CA	51.0	56.70	62.70	5	82.4	61.9	2
5KP54A	5KP54CA	54.0	60.00	66.30	5	87.1	58.6	2
5KP58A	5KP58CA	58.0	64.40	71.20	5	93.6	54.5	2
5KP60A	5KP60CA	60.0	66.70	73.70	5	96.8	52.7	2
5KP64A	5KP64CA	64.0	71.10	78.60	5	103.0	49.5	2
5KP70A	5KP70CA	70.0	77.80	86.00	5	113.0	45.1	2
5KP75A	5KP75CA	75.0	83.30	92.10	5	121.0	42.1	2
5KP78A	5KP78CA	78.0	86.70	95.80	5	126.0	40.5	2
5KP85A	5KP85CA	85.0	94.40	104.0	5	137.0	37.2	2
5KP90A	5KP90CA	90.0	100.0	111.0	5	146.0	34.9	2
5KP100A	5KP100CA	100.0	110.0	123.0	5	162.0	31.5	2
5KP110A	5KP110CA	110.0	122.0	135.0	5	177.0	28.8	2
5KP120A	5KP120CA	120.0	133.0	147.0	5	193.0	26.4	2
5KP130A	5KP130CA	130.0	144.0	159.0	5	209.0	24.4	2
5KP150A	5KP150CA	150.0	167.0	185.0	5	243.0	21.0	2
5KP160A	5KP160CA	160.0	178.0	197.0	5	259.0	19.7	2
5KP170A	5KP170CA	170.0	189.0	209.0	5	275.0	18.5	2
5KP180A	5KP180CA	180.0	201.0	222.0	5	292.0	17.5	2
5KP190A	5KP190CA	190.0	211.0	233.0	5	310.0	16.5	2
5KP200A	5KP200CA	200.0	224.0	247.0	5	329.2	15.5	2
5KP210A	5KP210CA	210.0	237.0	263.0	5	349.5	14.6	2
5KP220A	5KP220CA	220.0	246.0	272.0	5	371.1	13.7	2
5KP250A	5KP250CA	250.0	277.0	306.0	5	425.0	12.0	2

Ratings and Characteristic Curves ($T_A=25^\circ\text{C}$)

Figure 1. Peak Pulse Power Rating Curve

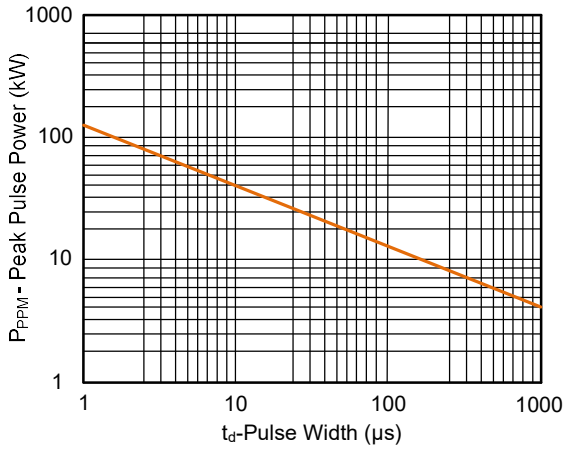

Figure 2. Pulse Derating Curve

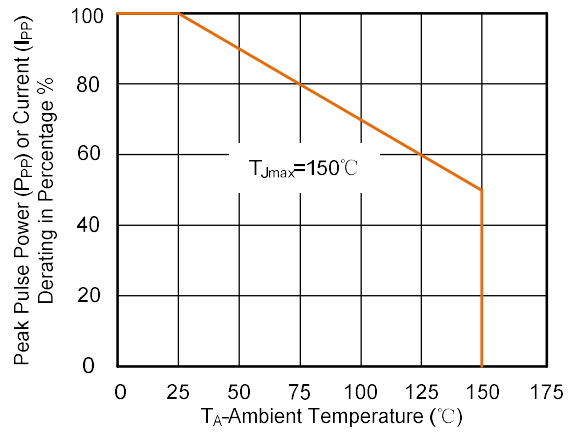

Figure 3. Pulse Waveform

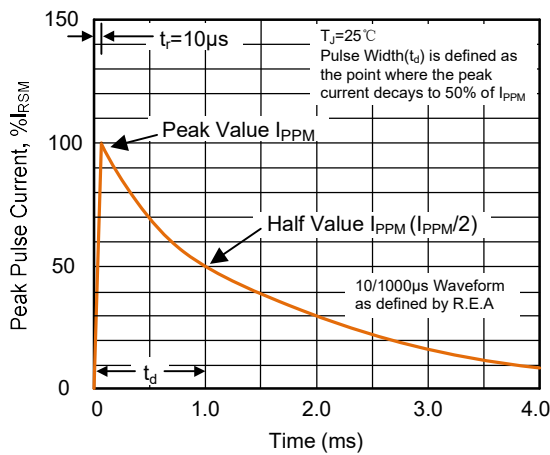

Figure 4. Typical Junction Capacitance

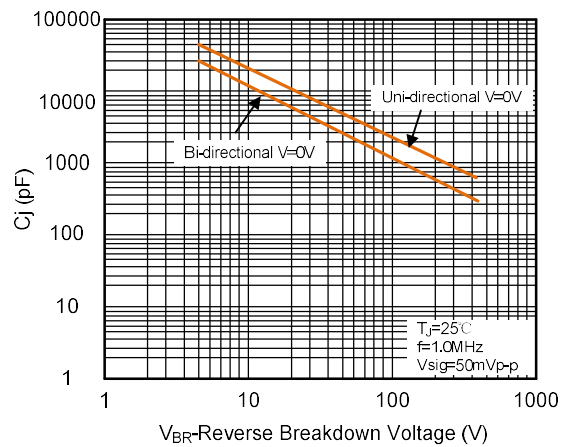

Figure 5. Steady State Power Dissipation Derating Curve

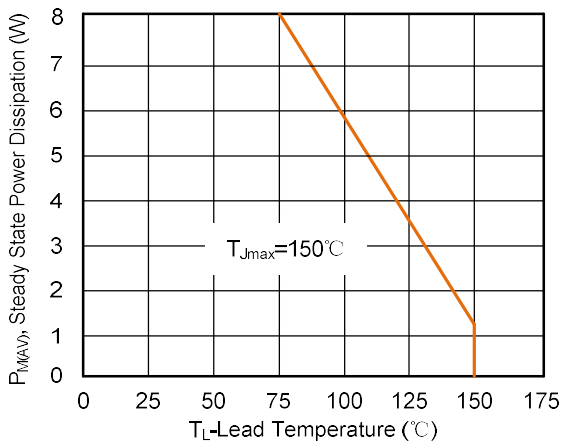
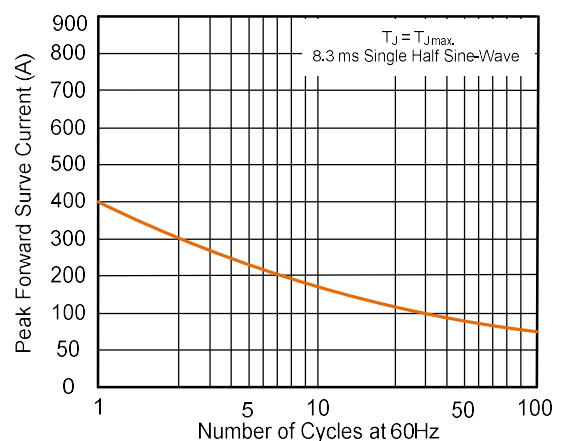
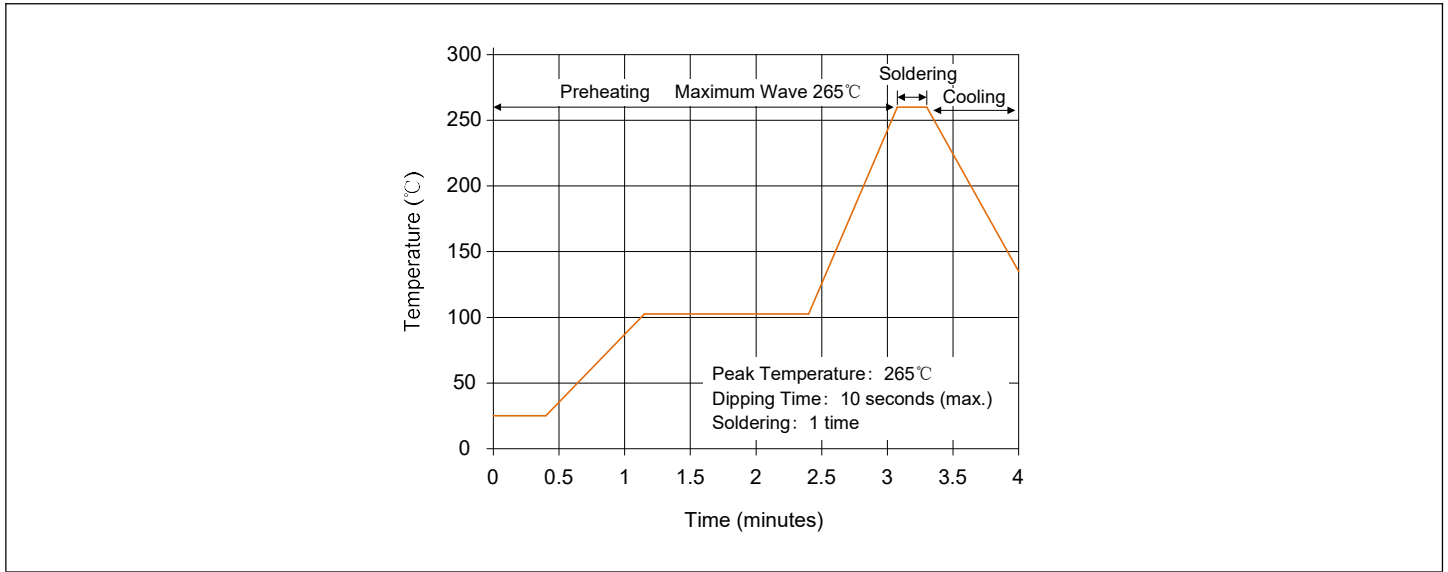

Figure 6. Maximum Non-Repetitive Forward Surge Current Uni-Directional Only



Wave Soldering



Part Number Code and Marking Code

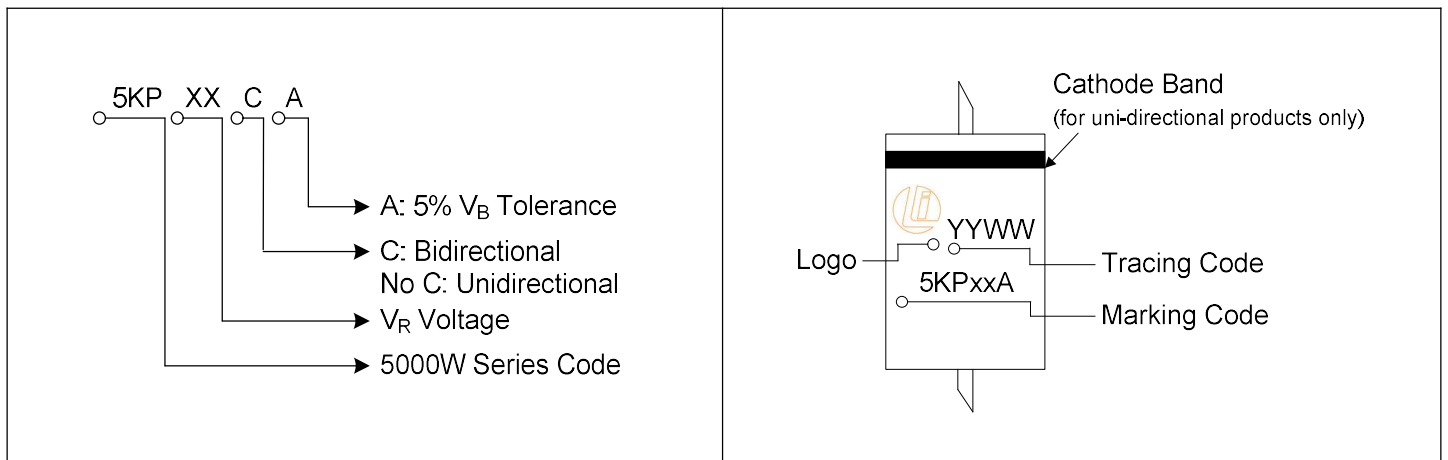

Dimensions (P600)

The diagram shows the dimensions of the TVS diode. A is the length of the leads, B is the width of the body, C is the height of the body, and d is the thickness of the leads.

Symbol	Millimeters		Inches	
	Min.	Max.	Min.	Max.
A	25.40	-	1.000	-
B	8.60	9.10	0.340	0.360
C	8.60	9.10	0.340	0.360
d	1.19	1.35	0.047	0.053

Packaging Specification

Tape

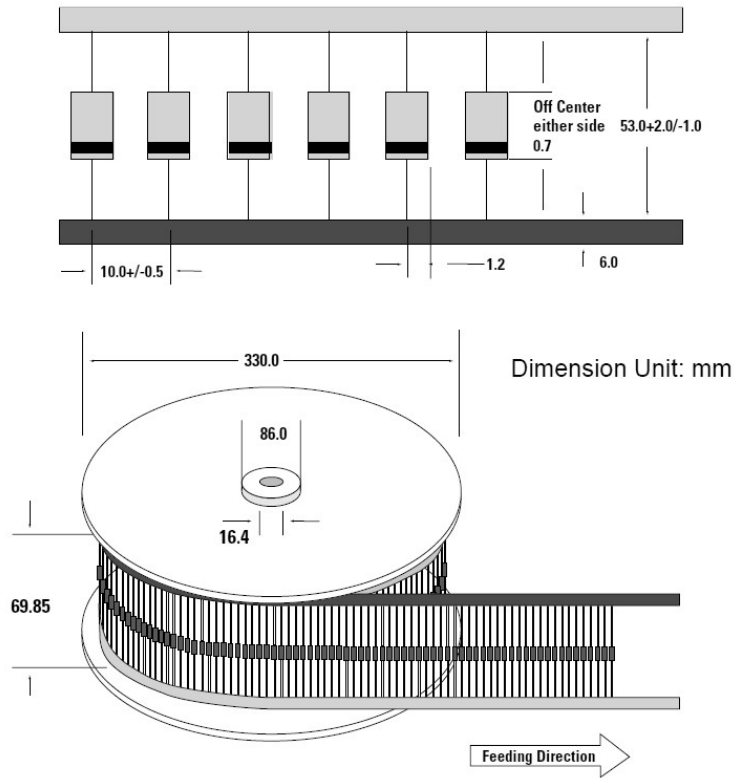

Quantity: 800pcs/reel

Box

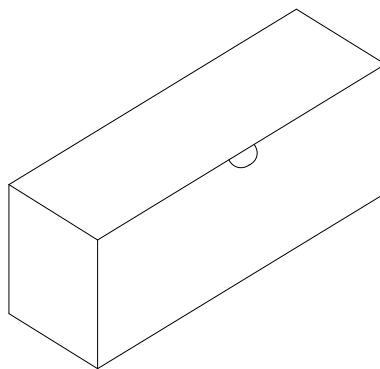

Quantity: 300pcs/box

单击下面可查看定价，库存，交付和生命周期等信息

[>>Liown\(里阳半导体\)](#)