

## Description

The 1.5SMC series is designed specifically to protect sensitive electronic equipment from voltage transients induced by lightning and other transient voltage events. For surface mounted applications in order to optimize board space.

## Features

- Halogen free and RoHS compliant
- Low profile package
- Built-in strain relief design
- Low inductance
- Excellent clamping capability
- 1500W peak pulse power capability at 10/1000μs waveform, repetition rate (duty cycle): 0.01%
- Fast response time
- Typical  $I_R$  less than 1μA above 12V devices
- Peak 260°C high temperature Reflow Soldering withstanding
- Meet MSL level1, per J-STD-020
- IEC-61000-4-2 ESD 30kV(Air), 30kV (Contact)
- Unit Weight: 0.26g

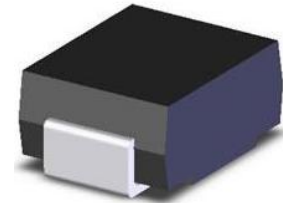

## Applications

TVS components are ideal for the protection of I/O Interfaces, VCC bus and other vulnerable circuits used in telecom, computer, Industrial and consumer electronic applications.

## Maximum Ratings and Characteristics ( $T_A=25^\circ\text{C}$ )

Rating	Symbol	Value
Peak pulse power dissipation at 10/1000μs waveform (Note1, Note2, Fig.1)	$P_{PPM}$	1500W
Peak pulse current of at 10/1000μs waveform (Note 1, Fig.3)	$I_{PPM}$	See Table(A)
Steady state power dissipation at $T_A=50^\circ\text{C}$ (Fig.5)	$P_{M(AV)}$	6.5W
Maximum Instantaneous Forward Voltage at 100A for Unidirectional Only	$V_F$	3.5V
Peak forward surge current, 8.3ms single half sine-wave superimposed on rated load, (JEDEC Method) (Note3, Fig.6)	$I_{FSM}$	200A
Operating junction and Storage Temperature Ranges	$T_J, T_{STG}$	$-55^\circ\text{C}$ to $+150^\circ\text{C}$
Typical thermal resistance junction to lead	$R_{\theta JL}$	$15^\circ\text{C/W}$
Typical thermal resistance junction to ambient	$R_{\theta JA}$	$75^\circ\text{C/W}$

Notes:1. Non-repetitive current pulse, per Fig.3 and derating above  $T_A=25^\circ\text{C}$  per Fig.2.

2. Each terminal is surface Mounted on the 8.0mm×8.0mm copper pads.

3. 8.3ms single half sine-wave or equivalent square wave, duty cycle=4 pulses per minutes maximum.

**Electrical Characteristics (T<sub>A</sub>=25°C)**

Part Number		Device Marking Code		Reverse Stand-Off Voltage	Breakdown Voltage @I <sub>T</sub>		Test Current	Maximum Clamping Voltage @I <sub>PP</sub>	Peak Pulse Current	Reverse Leakage @V <sub>R</sub>
Uni.	Bi.	Uni.	Bi.	V <sub>R</sub> (V)	V <sub>B Min.</sub> (V)	V <sub>B Max.</sub> (V)	I <sub>T</sub> (mA)	V <sub>C</sub> (V)	I <sub>PP</sub> (A)	I <sub>R</sub> (μA)
1.5SMC6.8A	1.5SMC6.8CA	6V8A	6V8C	5.80	6.45	7.14	10	10.5	144.8	1000
1.5SMC7.5A	1.5SMC7.5CA	7V5A	7V5C	6.40	7.13	7.88	10	11.3	134.5	500
1.5SMC8.2A	1.5SMC8.2CA	8V2A	8V2C	7.02	7.79	8.61	10	12.1	125.6	200
1.5SMC9.1A	1.5SMC9.1CA	9V1A	9V1C	7.78	8.65	9.55	1	13.4	113.4	50
1.5SMC10A	1.5SMC10CA	10A	10C	8.55	9.50	10.50	1	14.5	104.8	10
1.5SMC11A	1.5SMC11CA	11A	11C	9.40	10.50	11.60	1	15.6	97.4	5
1.5SMC12A	1.5SMC12CA	12A	12C	10.20	11.40	12.60	1	16.7	91.0	5
1.5SMC13A	1.5SMC13CA	13A	13C	11.10	12.40	13.70	1	18.2	83.5	1
1.5SMC15A	1.5SMC15CA	15A	15C	12.80	14.30	15.80	1	21.2	71.7	1
1.5SMC16A	1.5SMC16CA	16A	16C	13.60	15.20	16.80	1	22.5	67.6	1
1.5SMC18A	1.5SMC18CA	18A	18C	15.30	17.10	18.90	1	25.2	60.3	1
1.5SMC20A	1.5SMC20CA	20A	20C	17.10	19.00	21.00	1	27.7	54.9	1
1.5SMC22A	1.5SMC22CA	22A	22C	18.80	20.90	23.10	1	30.6	49.7	1
1.5SMC24A	1.5SMC24CA	24A	24C	20.50	22.80	25.20	1	33.2	45.8	1
1.5SMC27A	1.5SMC27CA	27A	27C	23.10	25.70	28.40	1	37.5	40.5	1
1.5SMC30A	1.5SMC30CA	30A	30C	25.60	28.50	31.50	1	41.4	36.7	1
1.5SMC33A	1.5SMC33CA	33A	33C	28.20	31.4	34.7	1	45.7	33.3	1
1.5SMC36A	1.5SMC36CA	36A	36C	30.80	34.2	37.8	1	49.9	30.5	1
1.5SMC39A	1.5SMC39CA	39A	39C	33.30	37.1	41.0	1	53.9	28.2	1
1.5SMC43A	1.5SMC43CA	43A	43C	36.80	40.9	45.2	1	59.3	25.6	1
1.5SMC47A	1.5SMC47CA	47A	47C	40.20	44.7	49.4	1	64.8	23.5	1
1.5SMC51A	1.5SMC51CA	51A	51C	43.60	48.5	53.6	1	70.1	21.7	1
1.5SMC56A	1.5SMC56CA	56A	56C	47.80	53.2	58.8	1	77.0	19.7	1
1.5SMC62A	1.5SMC62CA	62A	62C	53.00	58.9	65.1	1	85.0	17.9	1
1.5SMC68A	1.5SMC68CA	68A	68C	58.10	64.6	71.4	1	92.0	16.5	1

**Electrical Characteristics (T<sub>A</sub>=25°C)**

Part Number		Device Marking Code		Reverse Stand-Off Voltage	Breakdown Voltage @I <sub>T</sub>		Test Current	Maximum Clamping Voltage @I <sub>PP</sub>	Peak Pulse Current	Reverse Leakage @V <sub>R</sub>
Uni.	Bi.	Uni.	Bi.	V <sub>R</sub> (V)	V <sub>B Min.</sub> (V)	V <sub>B Max.</sub> (V)	I <sub>T</sub> (mA)	V <sub>C</sub> (V)	I <sub>PP</sub> (A)	I <sub>R</sub> (μA)
1.5SMC75A	1.5SMC75CA	75A	75C	64.10	71.3	78.8	1	103.0	14.8	1
1.5SMC82A	1.5SMC82CA	82A	82C	70.10	77.9	86.1	1	113.0	13.5	1
1.5SMC91A	1.5SMC91CA	91A	91C	77.80	86.5	95.5	1	125.0	12.2	1
1.5SMC100A	1.5SMC100CA	100A	100C	85.50	95.00	105.0	1	137.0	11.1	1
1.5SMC110A	1.5SMC110CA	110A	110C	94.00	105.00	116.0	1	152.0	10.0	1
1.5SMC120A	1.5SMC120CA	120A	120C	102.00	114.0	126.0	1	165.0	9.2	1
1.5SMC130A	1.5SMC130CA	130A	130C	111.00	124.0	137.0	1	179.0	8.5	1
1.5SMC150A	1.5SMC150CA	150A	150C	128.00	143.0	158.0	1	207.0	7.3	1
1.5SMC160A	1.5SMC160CA	160A	160C	136.00	152.0	168.0	1	219.0	6.9	1
1.5SMC170A	1.5SMC170CA	170A	170C	145.00	162.0	179.0	1	234.0	6.5	1
1.5SMC180A	1.5SMC180CA	180A	180C	154.00	171.0	189.0	1	246.0	6.2	1
1.5SMC200A	1.5SMC200CA	200A	200C	171.00	190.0	210.0	1	274.0	5.5	1
1.5SMC220A	1.5SMC220CA	220A	220C	185.00	209.0	231.0	1	328.0	4.6	1
1.5SMC250A	1.5SMC250CA	250A	250C	214.00	237.0	263.0	1	344.0	4.4	1
1.5SMC300A	1.5SMC300CA	300A	300C	256.00	285.0	315.0	1	414.0	3.7	1
1.5SMC350A	1.5SMC350CA	350A	350C	300.00	332.0	368.0	1	482.0	3.2	1
1.5SMC400A	1.5SMC400CA	400A	400C	342.00	380.0	420.0	1	548.0	2.8	1
1.5SMC440A	1.5SMC440CA	440A	440C	376.00	418.0	462.0	1	602.0	2.5	1
1.5SMC480A	1.5SMC480CA	480A	480C	408.00	456.0	504.0	1	658.0	2.3	1
1.5SMC510A	1.5SMC510CA	510A	510C	434.00	485.0	535.0	1	698.0	2.1	1
1.5SMC530A	1.5SMC530CA	530A	530C	450.00	503.5	556.5	1	725.0	2.1	1
1.5SMC540A	1.5SMC540CA	540A	540C	459.00	513.0	567.0	1	740.0	2.0	1
1.5SMC550A	1.5SMC550CA	550A	550C	467.00	522.5	577.5	1	760.0	2.0	1
1.5SMC600A	1.5SMC600CA	600A	600C	510.00	575.2	628.4	1	828.0	1.8	1

**Ratings and Characteristic Curves ( $T_A=25^\circ\text{C}$ )**

Figure 1. Peak Pulse Power Rating Curve

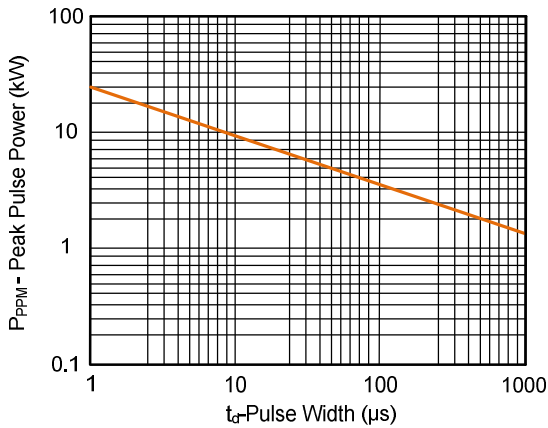

Figure 2. Pulse Derating Curve

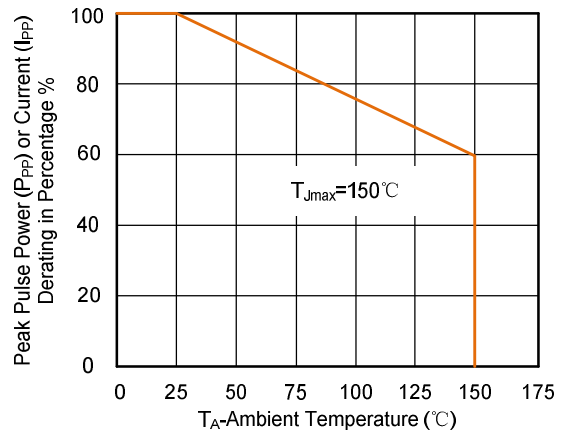

Figure 3. Pulse Waveform

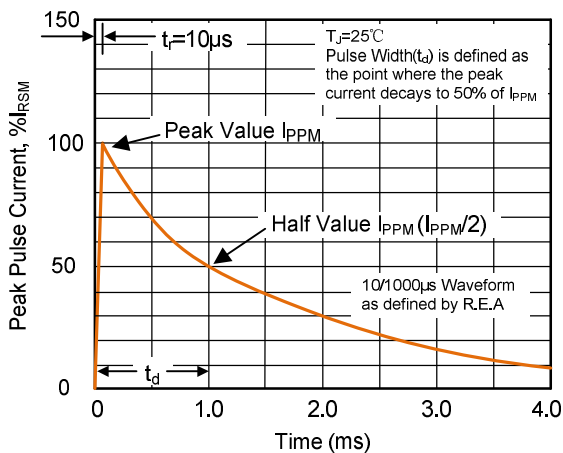

Figure 4. Typical Junction Capacitance

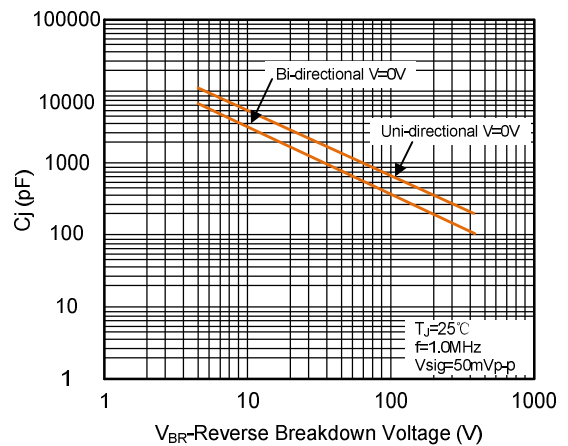

Figure 5. Steady State Power Dissipation Derating Curve

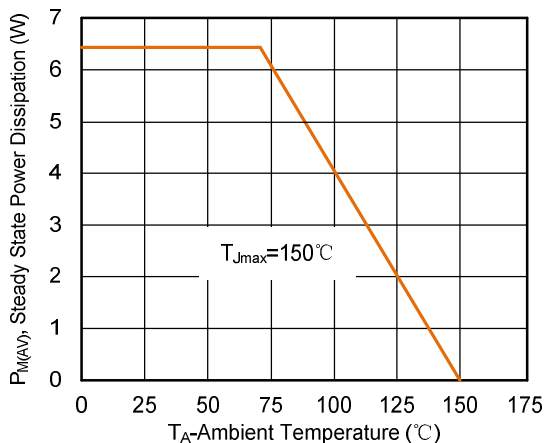
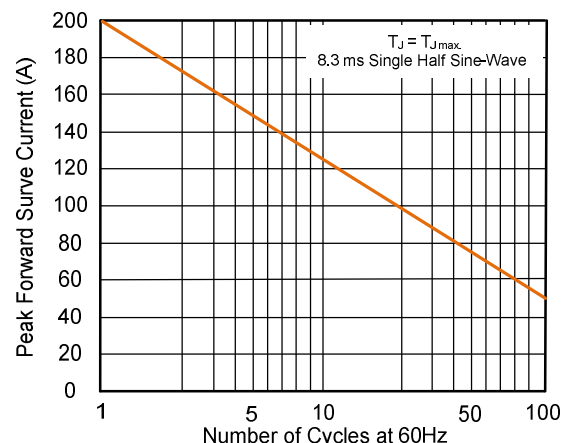
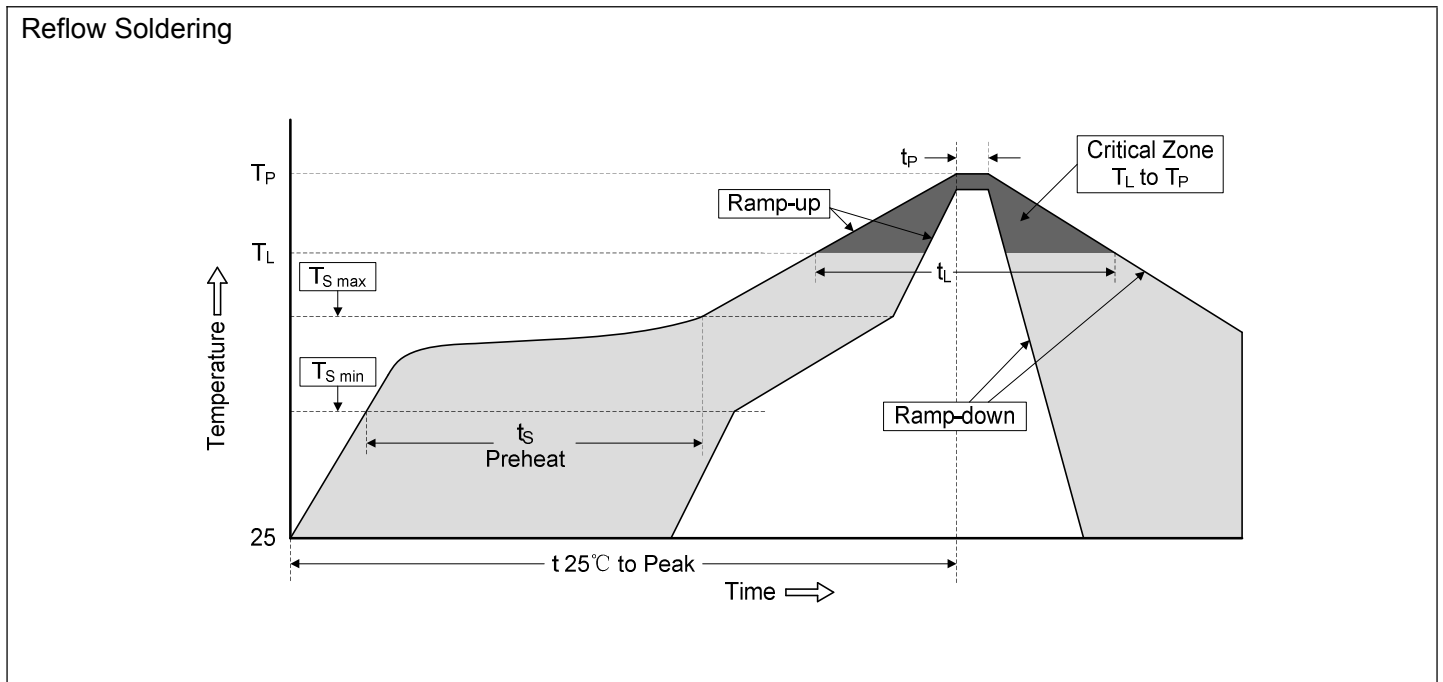

Figure 6. Maximum Non-Repetitive Forward Surge Current Uni-Directional Only



## Soldering Parameters



Profile Feature	Pb-Free Assembly
Average ramp-up rate ( $T_L$ to $T_P$ )	3°C/second max.
Preheat -Temperature Min ( $T_{S\ min}$ ) -Temperature Max ( $T_{S\ max}$ ) -Time (min to max) ( $t_s$ )	150°C 200°C 60-180 seconds
$T_{S\ max}$ to $T_L$ -Ramp-up Rate	3°C/second max.
Time maintained above: -Temperature ( $T_L$ ) -Time ( $t_L$ )	217°C 60-150 seconds
Peak Temperature ( $T_P$ )	260°C
Time within 5°C of actual Peak Temperature ( $t_p$ )	20-40 seconds
Ramp-down Rate	6°C/second max.
Time 25°C to Peak Temperature	8 minutes max.

### Part Number Code and Marking Code

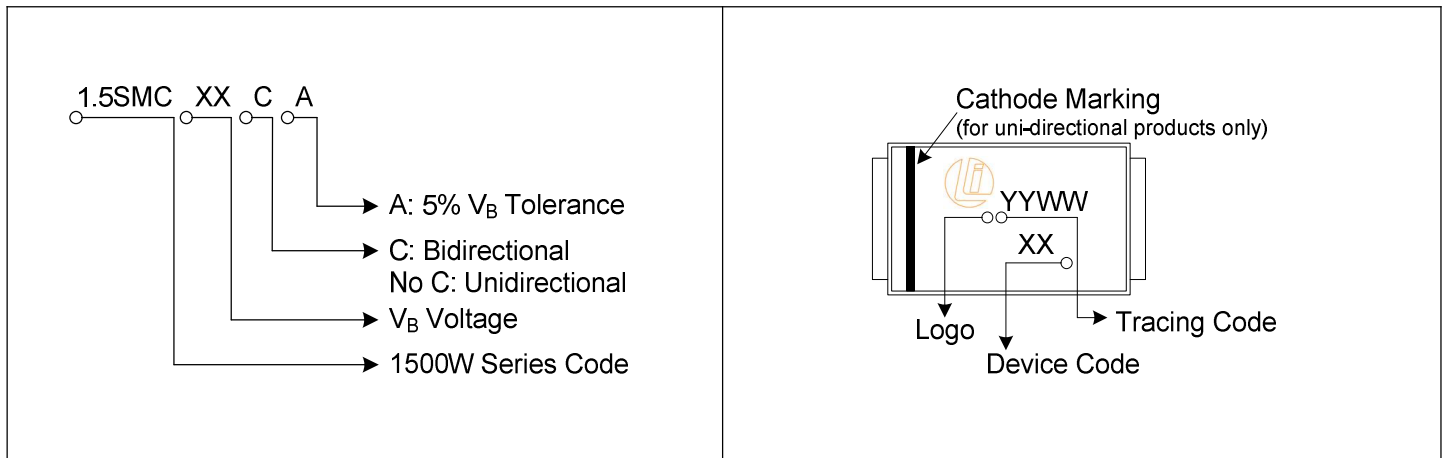

### Dimensions (SMC/DO-214AB)

Cathode Band  
(for uni-directional products only)

Symbol	Millimeters		Inches	
	Min.	Max.	Min.	Max.
A	2.900	3.200	0.114	0.126
B	6.600	7.110	0.260	0.280
C	5.590	6.220	0.220	0.245
D	2.060	2.620	0.079	0.103
E	0.760	1.520	0.030	0.060
F	-	0.203	-	0.008
G	7.750	8.130	0.305	0.320
H	0.152	0.305	0.006	0.012
T	2.200	2.750	0.087	0.108
I	3.300	-	0.129	-
J	2.400	-	0.094	-
K	-	4.200	-	0.165

## Packaging Specification

### Tape

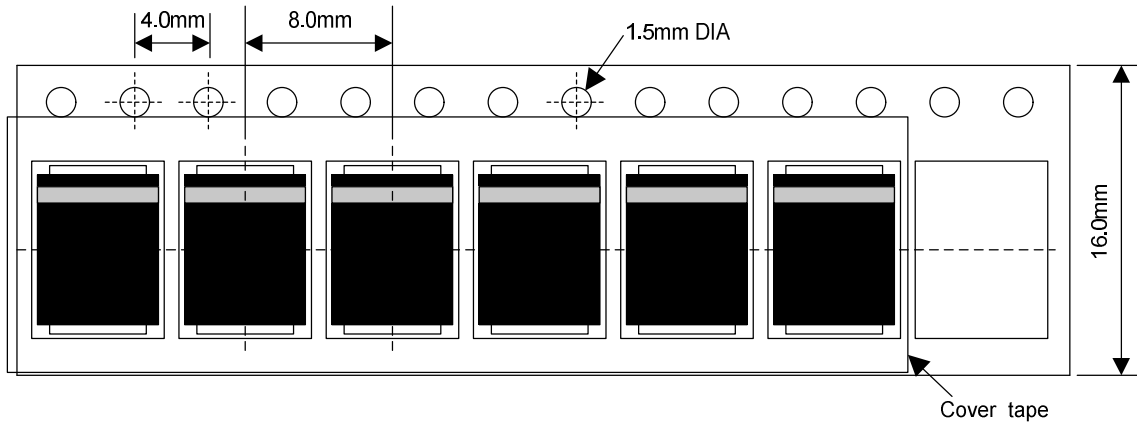

### For Uni-Devices

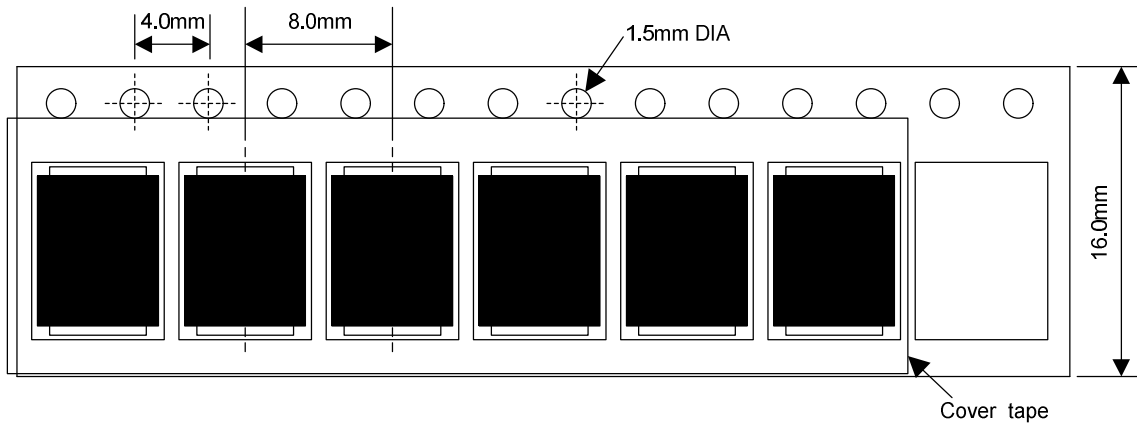

### 13 Inches Reel

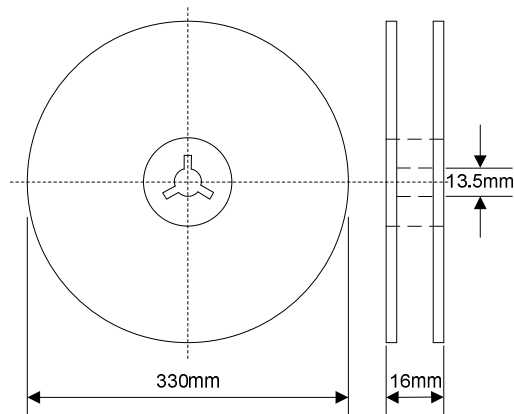

Quantity: 3000pcs/reel

单击下面可查看定价，库存，交付和生命周期等信息

[>>Liown\(里阳半导体\)](#)