



Photocoupler  
Product Data Sheet  
LTV-214

Spec No. :DS70-2010-0066  
Effective Date: 12/27/2018  
Revision: B

**LITE-ON DCC**

**RELEASE**

**BNS-OD-FC001/A4**

## Photocoupler LTV-2X4 series

### 1. DESCRIPTION

#### 1.1 Features

- Current transfer ratio (CTR) : MIN. 20% at  $I_F = \pm 1\text{mA}$ ,  $V_{CE} = 5\text{V}$
- High input-output isolation voltage. ( $V_{iso}=3,750\text{Vrms}$ )
- Employs double transfer mold technology
- Safety approval:
  - UL 1577
  - VDE DIN EN60747-5-5 (VDE 0884-5) ,
  - CSA CA5A
  - DEMKO/FIMKO/SEMKO/NEMKO
  - CQC GB4943.1-2011/ GB8898-2011
- RoHS Compliance: All materials be used in device are followed EU RoHS directive (No.2002/95/EC, 2011/65/EU, and 2015/863).
- ESD pass HBM 6000V/MM2000V
- MSL class1

#### 1.2 Applications

- Hybrid substrates that require high density mounting.
- Programmable controllers
- System appliances, measuring instruments

## Photocoupler LTV-2X4 series

### 2. PACKAGE DIMENSIONS

#### 2.1 LTV-214

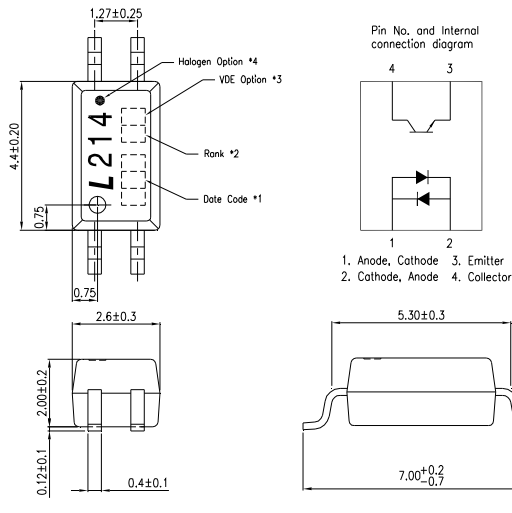

#### 2.2 LTV-224

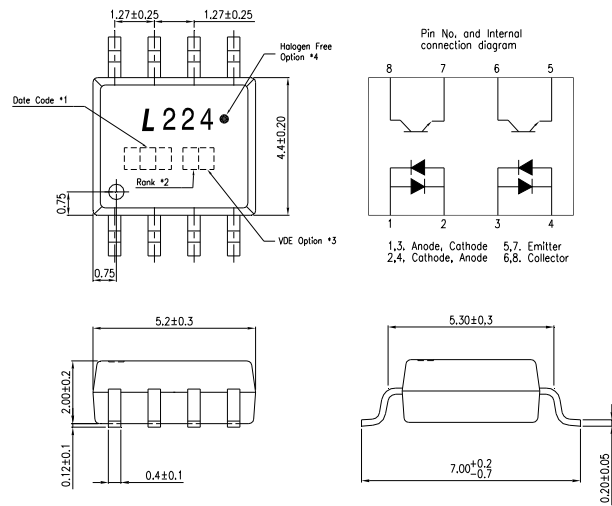

#### 2.3 LTV-244

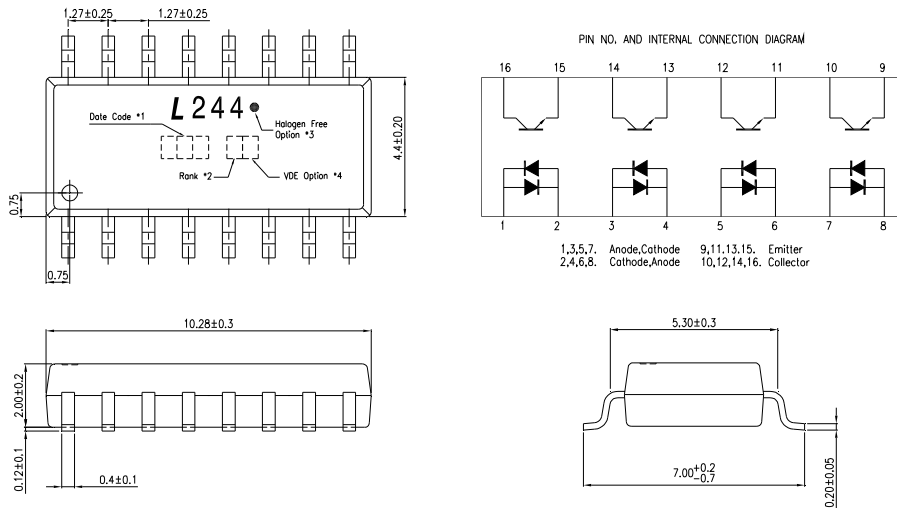

#### Notes :

- 1-digit year code, Example : 2010 = A  
2-digit work week ranging from '01' to '53'
- Rank shall be or shall not be marked.
- “●” for halogen free option.
- VDE mark only appears on devices ordered “V” option.

\* Dimensions are in Millimeters.

## Photocoupler LTV-2X4 series

### 3. TAPING DIMENSIONS

#### 3.1 LTV-214

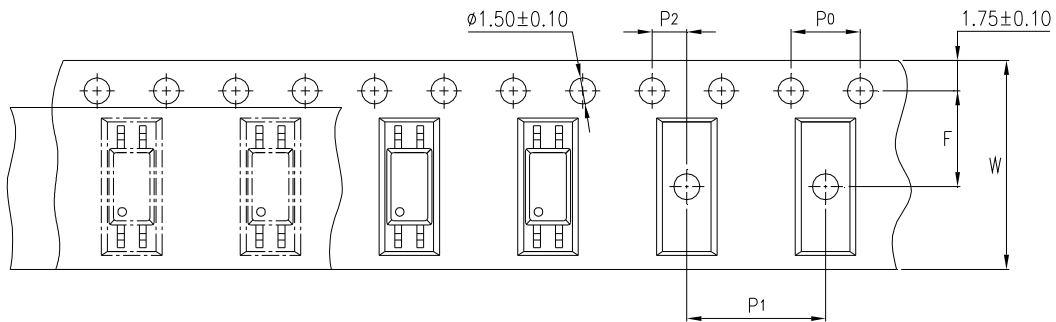

#### 3.2 LTV-214-TP1

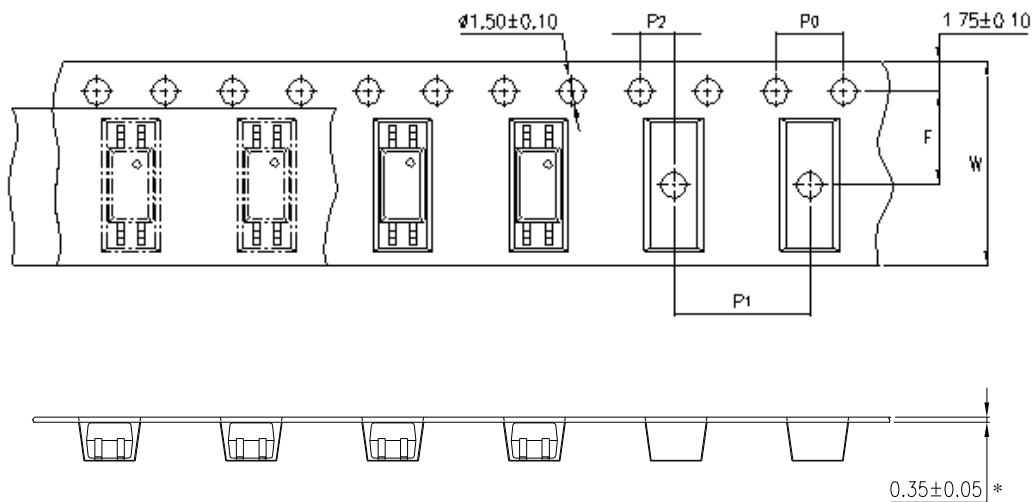

Description	Symbol	Dimension in mm (inch)
Tape wide	W	$12 \pm 0.3$ (0.47)
Pitch of sprocket holes	$P_0$	$4 \pm 0.1$ (0.15)
Distance of compartment	F	$5.5 \pm 0.1$ (0.217)
	$P_2$	$2 \pm 0.1$ (0.079)
Distance of compartment to compartment	$P_1$	$8 \pm 0.1$ (0.315)

## Photocoupler LTV-2X4 series

### 3.3 LTV-224

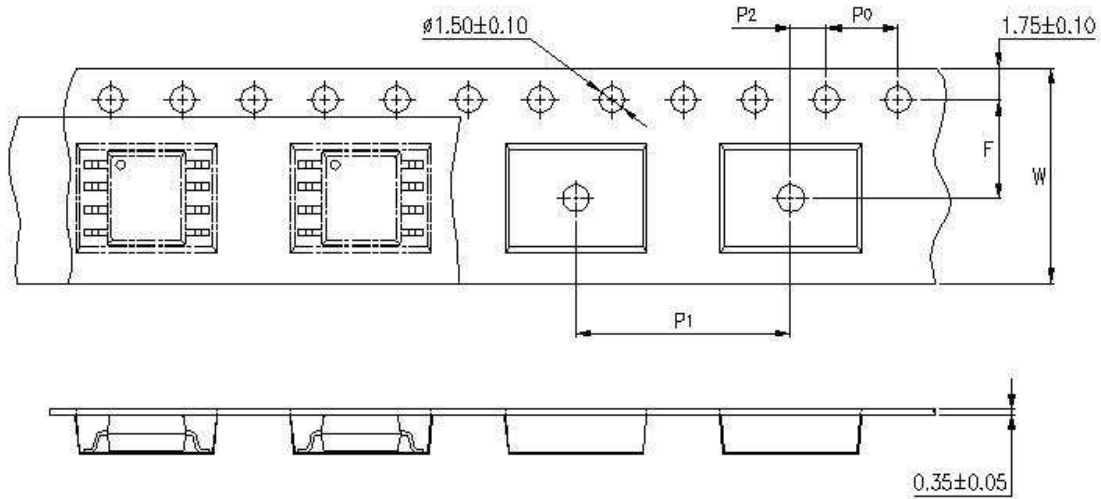

Description	Symbol	Dimension in mm (inch)
Tape wide	W	$12 \pm 0.3$ (0.47)
Pitch of sprocket holes	$P_0$	$4 \pm 0.1$ (0.15)
Distance of compartment	F	$5.5 \pm 0.1$ (0.217)
	$P_2$	$2 \pm 0.1$ (0.079)
Distance of compartment to compartment	$P_1$	$12 \pm 0.1$ (0.472)

## Photocoupler LTV-2X4 series

### 3.4 LTV-244

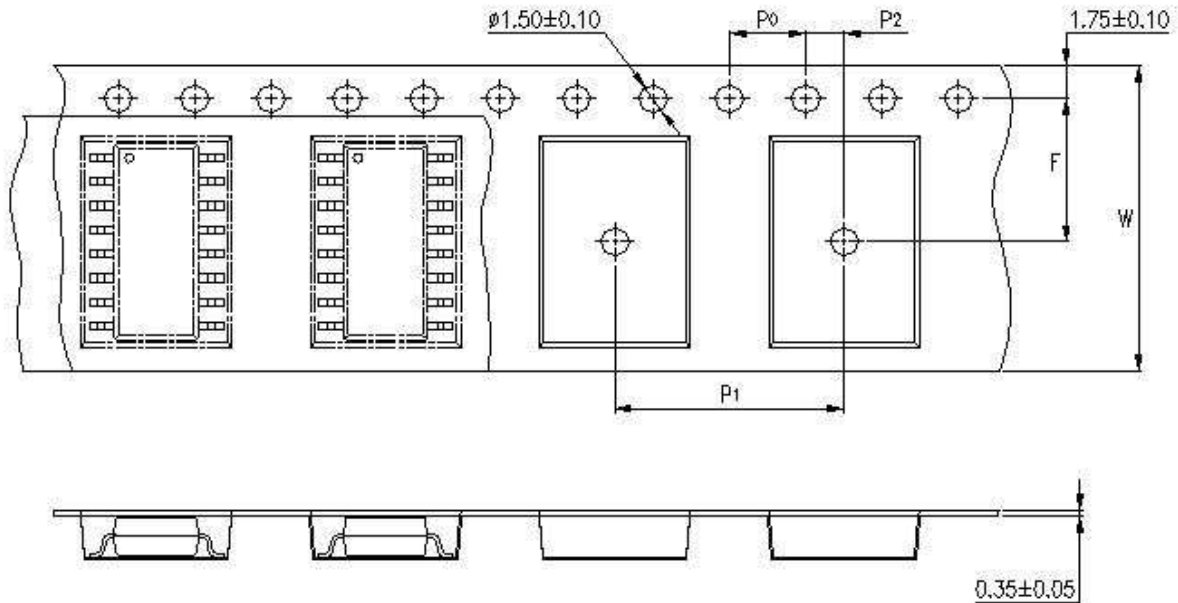

Description	Symbol	Dimension in mm (inch)
Tape wide	W	16±0.3 (0.63)
Pitch of sprocket holes	$P_0$	4±0.1 (0.15)
Distance of compartment	F	7.5±0.1 (0.295)
	$P_2$	2±0.1 (0.079)
Distance of compartment to compartment	$P_1$	12±0.1 (0.472)

### 3.5 Quantities per Reel

Package Type	LTV-214	LTV-224	LTV-244
Quantities (pcs)	3000	2000	2000

## Photocoupler LTV-2X4 series

### 4. RATING AND CHARACTERISTICS

#### 4.1 Absolute Maximum Ratings at Ta=25°C

	Parameter	Symbol	Rating			Unit
			214	224	244	
Input	Forward Current	$I_F$	±50			mA
	Power Dissipation	P	65			mW
	Pulse Forward Current	$I_{FSM}$	±1			A
	Junction Temperature	$T_J$	125			°C
Output	Collector - Emitter Voltage	$V_{CEO}$	80			V
	Emitter - Collector Voltage	$V_{ECO}$	7			V
	Collector Current	$I_C$	50			mA
	Collector Power Dissipation	$P_C$	150	100		mW
	Junction Temperature	$T_J$	125			°C
	Total Power Dissipation	$P_{tot}$	200	170		mW
1.	Isolation Voltage	$V_{iso}$	3750			$V_{rms}$
	Operating Temperature	$T_{opr}$	-55 ~ +110			°C
	Storage Temperature	$T_{stg}$	-55 ~ +150			°C
	Soldering Temperature	$T_{sol}$	260(10s)			°C

1. AC For 1 Minute, R.H. = 40 ~ 60%

Isolation voltage shall be measured using the following method.

- (1) Short between anode and cathode on the primary side and between collector and emitter on the secondary side.
- (2) The isolation voltage tester with zero-cross circuit shall be used.
- (3) The waveform of applied voltage shall be a sine wave.

## Photocoupler LTV-2X4 series

### 4.2 ELECTRICAL OPTICAL CHARACTERISTICS at Ta=25°C

Parameter		Symbol	Min.	Typ.	Max.	Unit	Test Condition
Input	Forward Voltage	$V_F$	—	1.2	1.4	V	$I_F=\pm 20\text{mA}$
	Terminal Capacitance	$C_t$	—	60	—	pF	$V=0, f=1\text{KHz}$
Output	Collector Dark Current	$I_{CEO}$	—	—	100	nA	$V_{CE}=20\text{V}, I_F=0$
	Collector-Emitter Breakdown Voltage	$BV_{CEO}$	80	—	—	V	$I_C=0.1\text{mA}, I_F=0$
	Emitter-Collector Breakdown Voltage	$BV_{ECO}$	7	—	—	V	$I_E=10\mu\text{A}, I_F=0$
TRANSFER CHARACTERISTICS	Collector-Emitter Saturation Voltage	$V_{CE(sat)}$	—	—	0.4	V	$I_F\pm 8\text{mA}, I_C=2.4\text{mA}$
	Isolation Resistance	$R_{iso}$	$5\times 10^{10}$	$1\times 10^{11}$	—	$\Omega$	DC500V, 40 ~ 60% R.H.
	Floating Capacitance	$C_f$	—	0.8	1	pF	$V=0, f=1\text{MHz}$
	Response Time (Rise)	$t_r$	—	3	18	$\mu\text{s}$	$V_{CC}=2\text{V}, I_C=\pm 2\text{mA}$
	Response Time (Fall)	$t_f$	—	4	18	$\mu\text{s}$	$R_L=100\Omega, f=100\text{Hz}$



## Photocoupler LTV-2X4 series

### 5. RANK TABLE OF CURRENT TRANSFER RATIO

Model No.	CTR Rank	Min	Max	Condition
LTV-214	0	20	400	$I_F = \pm 1\text{mA}$ , $V_{CE} = 5\text{V}$ , $T_a = 25^\circ\text{C}$
	A	50	250	
	AK	100	200	
	B	100	400	
	GR	100	300	$I_F = \pm 5\text{mA}$ , $V_{CE} = 5\text{V}$ , $T_a = 25^\circ\text{C}$
LTV-224 LTV-244	0	20	400	$I_F = \pm 1\text{mA}$ , $V_{CE} = 5\text{V}$ , $T_a = 25^\circ\text{C}$
	A5	100	300	
	GB	100	400	$I_F = \pm 5\text{mA}$ , $V_{CE} = 5\text{V}$ , $T_a = 25^\circ\text{C}$

$$\text{CTR} = \frac{I_C}{I_F} \times 100\%$$

## Photocoupler LTV-2X4 series

### 6. CHARACTERISTICS CURVES

Figure 1. Collector Power Dissipation vs. Ambient Temperature

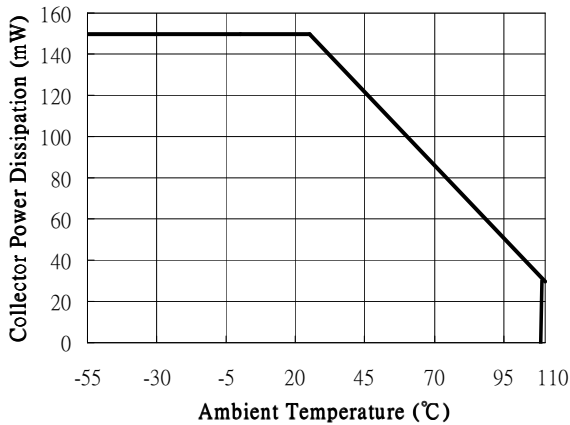

Figure 2. Forward Current vs. Ambient Temperature

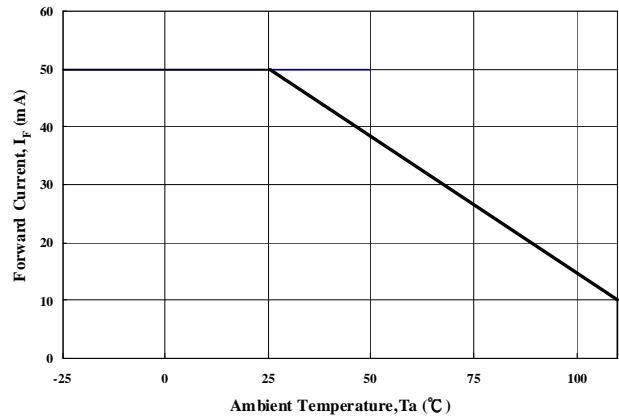

Figure 3. Forward Current vs. Forward Voltage

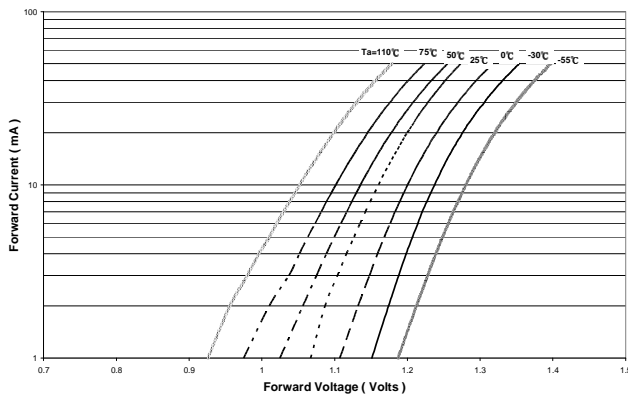

Figure 4. Forward Voltage Temperature Coefficient vs.

Forward Current

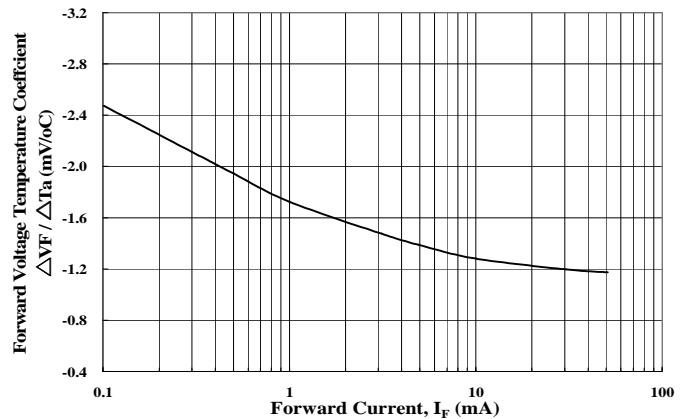

Figure 5. Pulse Forward Current vs. Duty Cycle Ratio

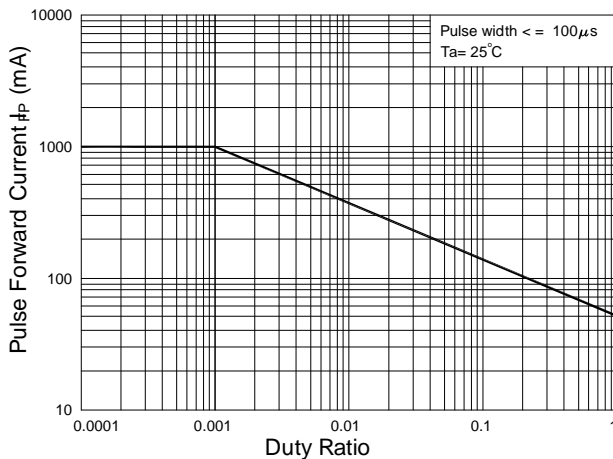
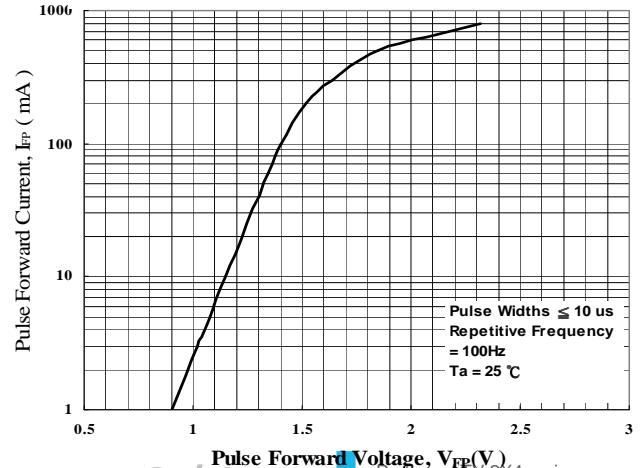

Figure 6. Pulse Forward Current vs. Pulse Forward



Part no.: LTV-2X4 series  
BNC-OD-FC002/A4  
Rev.: B

## Photocoupler LTV-2X4 series

Figure 7. Collector-Emitter Saturation Voltage vs. Forward Current

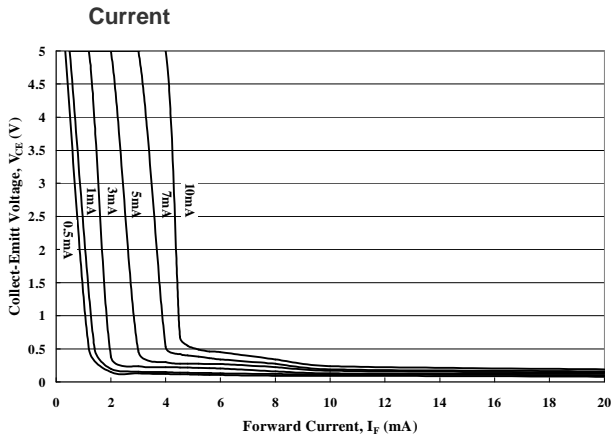

Figure 8. Collector Current vs. Collector-Emitter

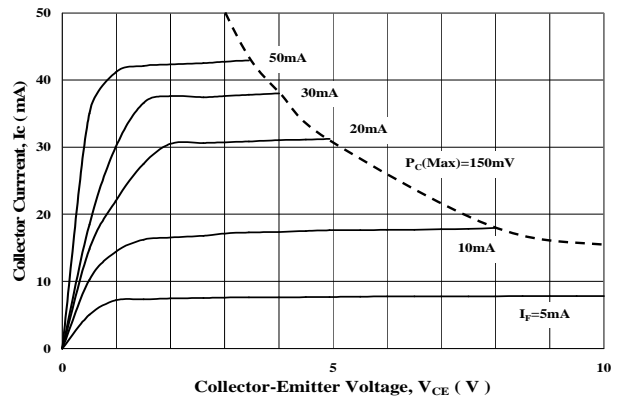

Figure 9. Collector Current vs. Small Collector-Emitter Voltage

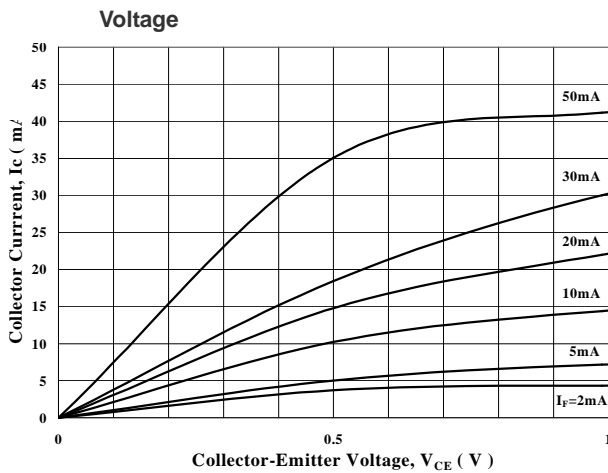

Figure 10. Collector Current vs. Forward Current

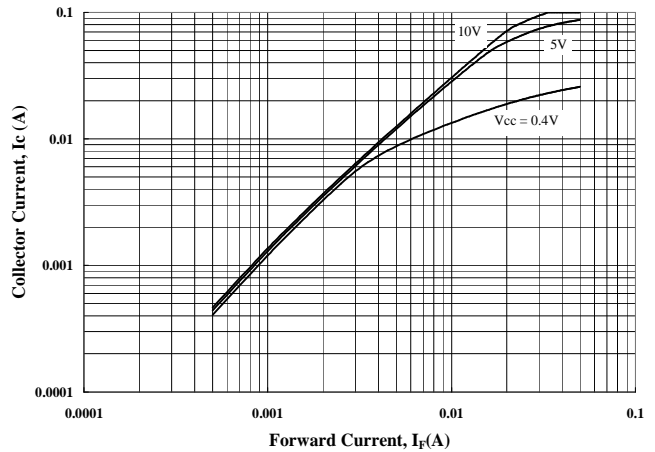

Figure 11. Collector Dark Current vs. Ambient Temperature

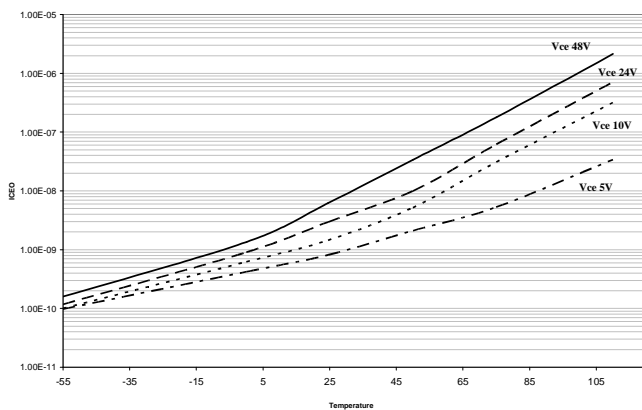
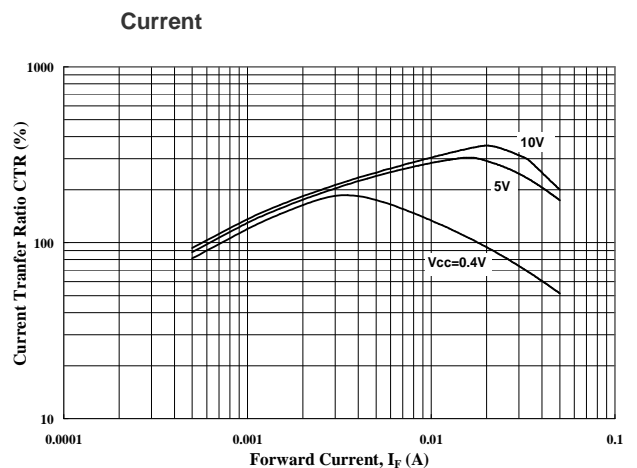

Figure 12. Current Transfer Ratio vs. Forward Current



## Photocoupler LTV-2X4 series

Figure 13. Collector-Emitter Saturation Voltage vs. Ambient Temperature

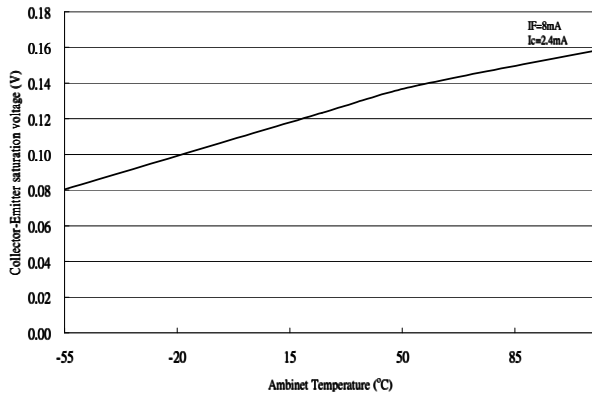

Figure 14. Collector Current vs. Ambient Temperature

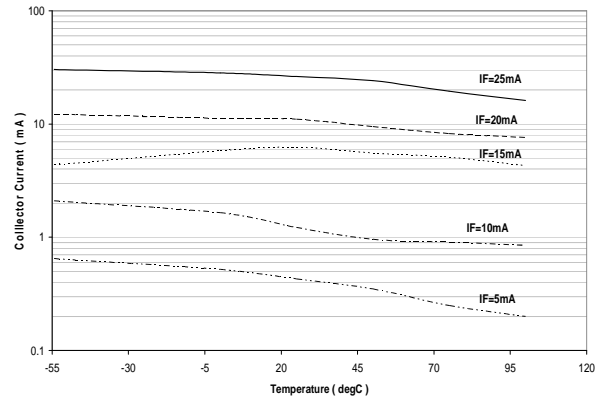

Figure 15. Switching Time vs. Load Resistance

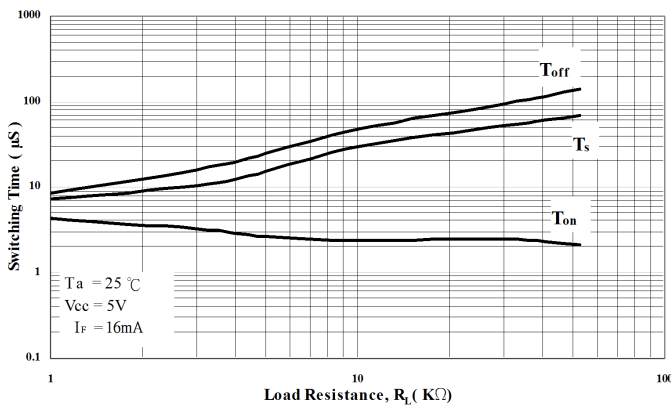

Figure 16. Switching Time vs. Ambient Temperature

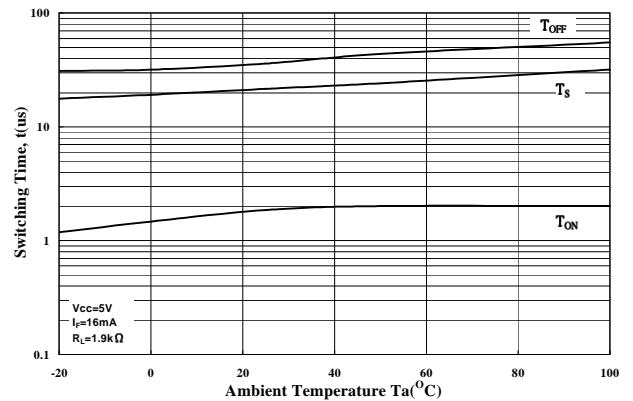
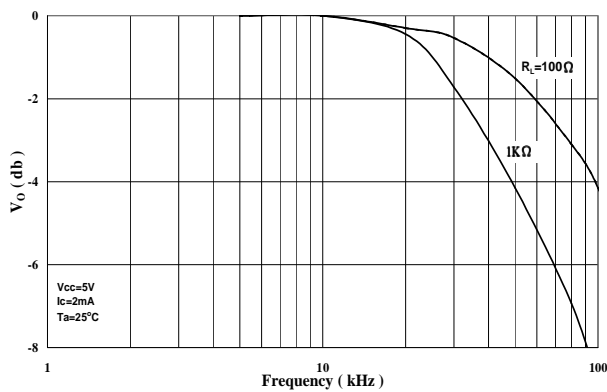
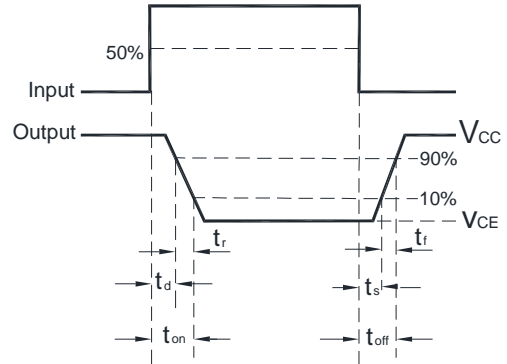
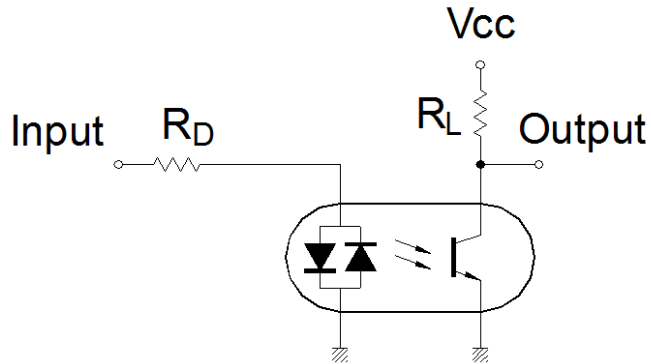

Figure 17. Frequency Response



## Photocoupler LTV-2X4 series

### 7. SWITCHING TIME TEST CIRCUIT



### 8. TEMPERATURE PROFILE OF SOLDERING

#### 8.1 IR Reflow soldering (JEDEC-STD-020C compliant)

One time soldering reflow is recommended within the condition of temperature and time profile shown below. Do not solder more than three times.

Profile item	Conditions
Preheat	
- Temperature Min ( $T_{Smin}$ )	150°C
- Temperature Max ( $T_{Smax}$ )	200°C
- Time (min to max) (ts)	90±30 sec
Soldering zone	
- Temperature ( $T_L$ )	217°C
- Time ( $t_L$ )	60 ~ 100 sec
Peak Temperature ( $T_P$ )	260°C
Ramp-up rate	3°C / sec max.
Ramp-down rate	3~6°C / sec



**Photocoupler  
LTV-2X4 series**

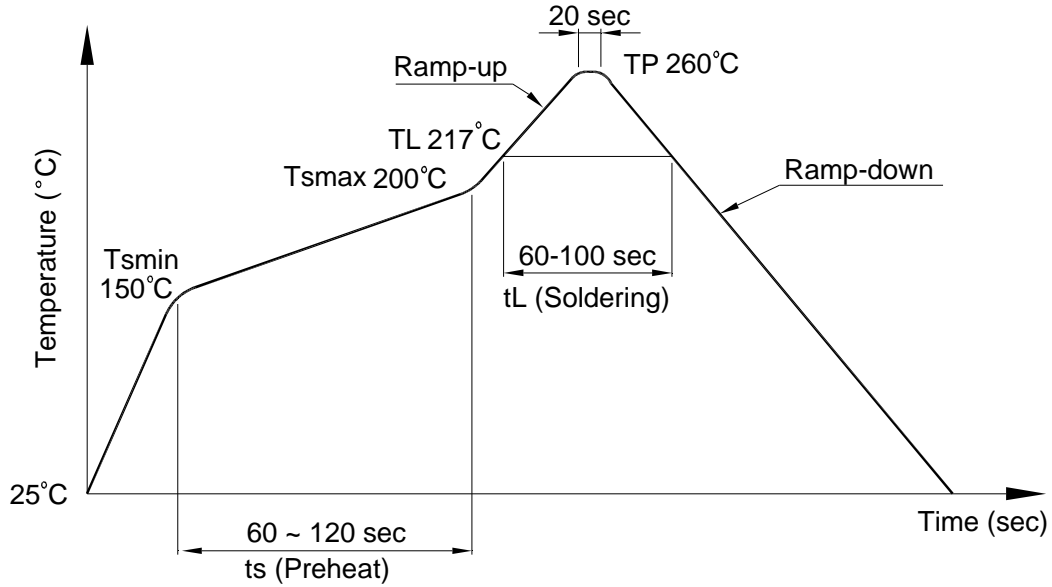

**8.2 Wave soldering (JEDEC22A111 compliant)**

One time soldering is recommended within the condition of temperature.

Temperature:  $260 \pm 0/-5^\circ\text{C}$

Time: 10 sec.

Preheat temperature: 25 to  $140^\circ\text{C}$

Preheat time: 30 to 80 sec.

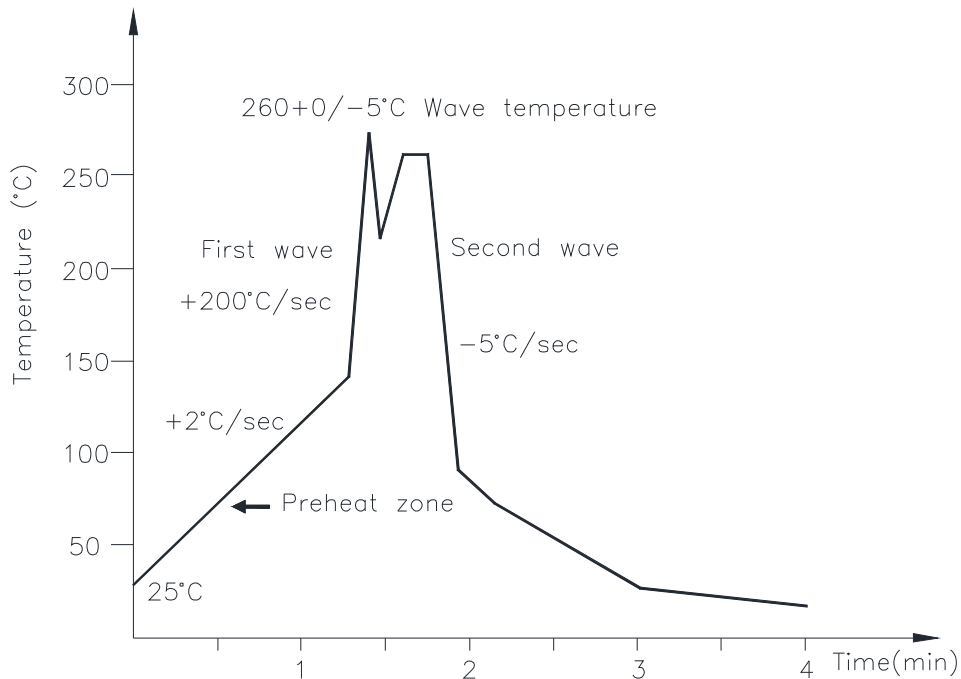

## Photocoupler LTV-2X4 series

### 8.3 Hand soldering by soldering iron

Allow single lead soldering in every single process. One time soldering is recommended.

Temperature: 380+0/-5°C

Time: 3 sec max.

## 9. RECOMMENDED FOOT PRINT PATTERNS (MOUNT PAD)

Unit: mm

### 9.1 LTV-214

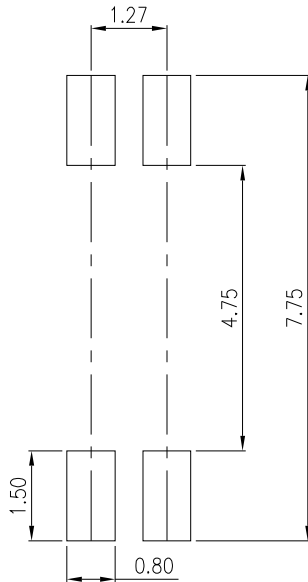

### 9.2 LTV-224

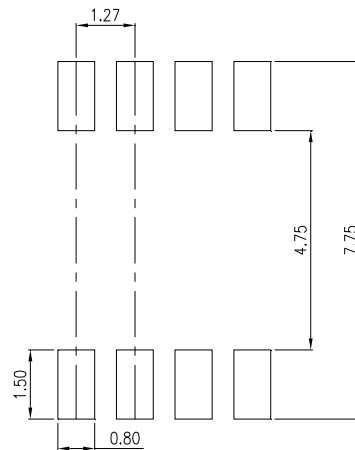

### 9.3 LTV-244

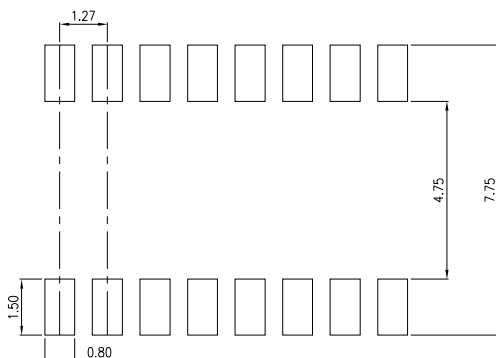

**Photocoupler  
LTV-2X4 series**

**10. NAMING RULE**

**LTV-2X4-(1)-(2)-G**

DEVICE PART NUMBER

(1) TAPING TYPE (TP1 or no suffix)

Please refer to orientation of taping on Page P3-P5

(2) CTR RANK

Please refer to the CTR table on Page P8

(3) Halogen free option

Example : LTV-214-TP1-A-G

**LTV2X4(1)(2)-V-G**

DEVICE PART NUMBER

(1) TAPING TYPE (TP1 or no suffix)

Please refer to orientation of taping on Page P3-P5

(2) CTR RANK

Please refer to the CTR table on Page P8

(3) VDE order option

(4) Halogen free option

Example : LTV214TP1A-V-G

**11. NOTES**

- LiteOn is continually improving the quality, reliability, function or design and LiteOn reserves the right to make changes without further notices.
- The products shown in this publication are designed for the general use in electronic applications such as office automation equipment, communications devices, audio/visual equipment, electrical application and instrumentation.
- For equipment/devices where high reliability or safety is required, such as space applications, nuclear power control equipment, medical equipment, etc, please contact our sales representatives.
- When requiring a device for any "specific" application, please contact our sales in advice.
- If there are any questions about the contents of this publication, please contact us at your convenience.
- The contents described herein are subject to change without prior notice.
- Immerge unit's body in solder paste is not recommended.



单击下面可查看定价，库存，交付和生命周期等信息

[>>Lite-On\(光宝\)](#)