



Photocopier Product Data Sheet LTV-100X-G series datasheet

Spec No. :DS70-2013-0012

Effective Date: 10/04/2018

Revision: 1.1

LITE-ON DCC

RELEASE

BNS-OD-FC001/A4

Photocoupler LTV-10XX-G series

1. DESCRIPTION

1.1 Features

- Current transfer ratio (CTR : MIN. 50% at $I_F = 5\text{mA}$, $V_{CE} = 5\text{V}$, $T_a = 25^\circ\text{C}$)
- High input-output isolation voltage ($V_{iso} = 5,000\text{Vrms}$)
- High collector-emitter voltage ($V_{CEO} = 70\text{V}$)
- Temperature range -55°C to 110°C
- Creepage distance $> 8\text{mm}$
- Employs double transfer mold technology
- Long Mini-flat package: LTV-10XX series
- Halogen Free
- Pb Free
- Safety approval
 - UL 1577
 - Cul CA5A
 - VDE DIN EN60747-5-5 (VDE 0884-5) Maximum transient isolation voltage (VIOTM) 8,000V
 - CQC GB4943.1-2011/ GB8898-2011 (meet Altitude up to 5000m)
 - Nordic Safety (FIMKO/NEMKO/SEMKO/DEMKO)
- RoHS Compliance
 - All materials be used in device are followed EU RoHS directive (No.2002/95/EC, 2011/65/EU, and 2015/863).

1.2 Applications

- Hybrid substrates that require high density mounting.
- Programmable controllers

Photocoupler LTV-10XX-G series

2. PACKAGE DIMENSIONS

2.1 LTV-10XX-G series

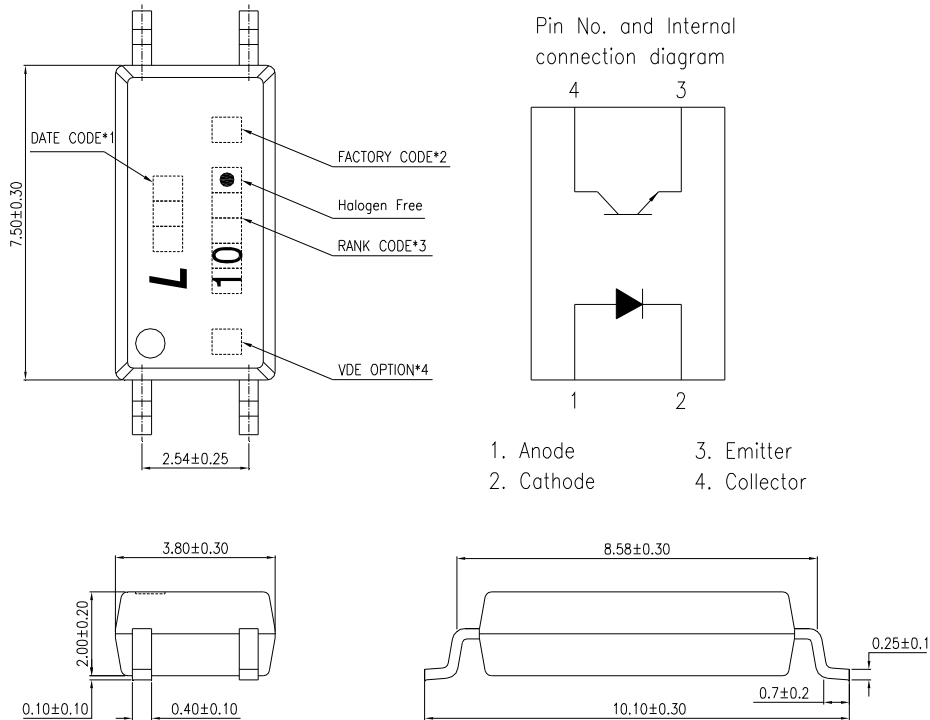

Notes :

1. 1-digit year code, Example : 2010 = A
2-digit work week ranging from '01' to '53'
2. Factory identification mark shall be marked. (W : China-CZ, X: China -TJ)
3. CTR rank.
4. "V" for VDE option.

*All dimensions in millimeters.

Photocoupler LTV-10XX-G series

3. TAPING DIMENSIONS

3.1 LTV-10XX-TP

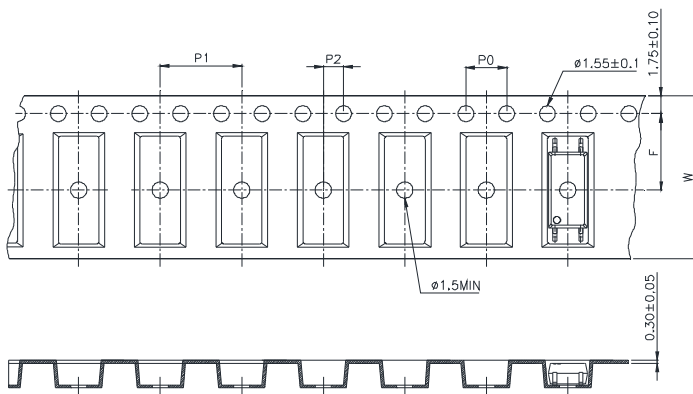

3.2 LTV-10XX-TP1

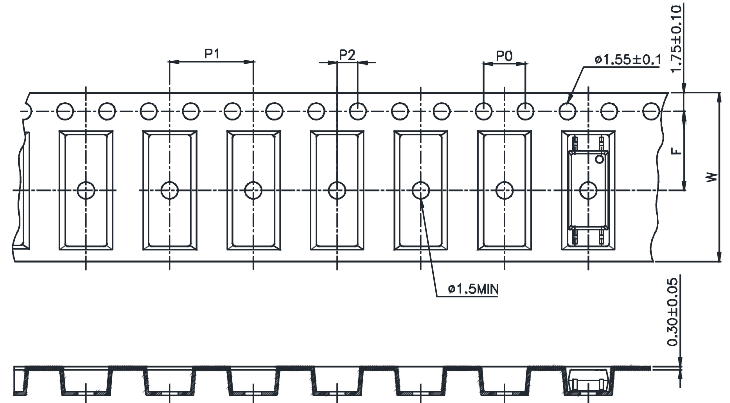

Description	Symbol	Dimension in mm (inch)
Tape wide	W	16±0.3 (.63)
Pitch of sprocket holes	P ₀	4±0.1 (.15)
Distance of compartment	F	7.5±0.1 (.295)
	P ₂	2±0.1 (.079)
Distance of compartment to compartment	P ₁	8±0.1 (.315)

3.3 Quantities Per Reel

Package Type	LTV-10XX series
Quantities (pcs)	3000

Photocoupler LTV-10XX-G series

4. RATING AND CHARACTERISTICS

4.1 Absolute Maximum Ratings at Ta=25°C

	Parameter	Symbol	Rating	Unit
Input	Forward Current	I_F	60	mA
	Reverse Voltage	V_R	6	V
	Power Dissipation	P	100	mW
	Junction Temperature	T_J	125	°C
	Thermal Resistance Junction to Ambient	R_{thJ-A}	250	°C/W
	Thermal Resistance Junction to Case	R_{thJ-C}	180	°C/W
Output	Collector - Emitter Voltage	V_{CEO}	70	V
	Emitter - Collector Voltage	V_{ECO}	7	V
	Collector Current	I_C	50	mA
	Collector Power Dissipation	P_C	150	mW
	Junction Temperature	T_J	125	°C
	Total Power Dissipation	P_{tot}	250	mW
1.	Isolation Voltage	V_{iso}	5000	V_{rms}
	Operating Temperature	T_{opr}	-55 ~ +110	°C
	Storage Temperature	T_{stg}	-55 ~ +150	°C
2.	Soldering Temperature	T_{sol}	260	°C

1. AC For 1 Minute, R.H. = 40 ~ 60%

Isolation voltage shall be measured using the following method.

- (1) Short between anode and cathode on the primary side and between collector and emitter on the secondary side.
- (2) The isolation voltage tester with zero-cross circuit shall be used.
- (3) The waveform of applied voltage shall be a sine wave.

2. For 10 Seconds

Photocoupler LTV-10XX-G series

4.2 ELECTRICAL OPTICAL CHARACTERISTICS at Ta=25°C

Parameter		Symbol	Min.	Typ.	Max.	Unit	Test Condition
Input	Forward Voltage	V_F	—	1.25	1.6	V	$I_F=50\text{mA}$
	Reverse Current	I_R	—	—	10	μA	$V_R=4\text{V}$
	Terminal Capacitance	C_t	—	50	—	pF	$V=0, f=1\text{MHz}$
Output	Collector Dark Current	I_{CEO}	—	10	100	nA	$V_{CE}=20\text{V},$ $I_F=0\text{mA}$
	Collector- Emitter Breakdown Voltage	BV_{CEO}	70	—	—	V	$I_C=1\text{mA } I_F=0\text{mA}$
	Emitter-Collector Breakdown Voltage	BV_{ECO}	7	—	—	V	$I_E=100\mu\text{A},$ $I_F=0\text{mA}$
TRANSFER CHARACTERISTICS	Collector Current	I_C	2.5	—	30	mA	$I_F=5\text{mA}$
	1. Current Transfer Ratio	CTR	50	—	600	%	$V_{CE}=5\text{V}$
	Collector-Emitter Saturation Voltage	$V_{CE(sat)}$	—	—	0.3	V	$I_F=10\text{mA}$ $I_C=1\text{mA}$
	Isolation Resistance	R_{iso}	1×10^{12}	—	—	Ω	DC500V, 40 ~ 60% R.H.
	Floating Capacitance	C_f	—	0.3	—	pF	$V=0, f=1\text{MHz}$
	Response Time (Rise)	t_r	—	3	18	μs	$V_{CC}=5\text{V},$ $I_C=2\text{mA}$
	Response Time (Fall)	t_f	—	4.7	18	μs	$R_L=100\Omega,$

$$1. \text{CTR} = \frac{I_C}{I_F} \times 100\%$$

**Photocoupler
LTV-10XX-G series**

5. RANK TABLE OF CURRENT TRANSFER RATIO CTR

CTR Rank	Min.	Typ.	Max.	Unit	Condition
LTV-1000	50	—	600	%	$I_F=5\text{mA}, V_{CE}=5\text{V}, T_a=25^\circ\text{C}$
LTV-1001	100	—	160		
LTV-1004	100	—	200		
LTV-1005	50	—	150		
LTV-1006	100	—	300		
LTV-1007	80	—	160		
LTV-1008	130	—	260		
LTV-1009	200	—	400		
LTV-1010	150	—	300		
LTV-1019	250	—	500		
LTV-1002	22	—	—	%	$I_F=1\text{mA}, V_{CE}=5\text{V}, T_a=25^\circ\text{C}$
LTV-1003	34	—	—		
LTV-1014	56	—	—		
LTV-1015	63	—	125		
LTV-1018	100	—	200	%	$I_F=10\text{mA}, V_{CE}=5\text{V}, T_a=25^\circ\text{C}$
LTV-1002	63	—	125		
LTV-1003	100	—	200		
LTV-1014	160	—	320		

Photocoupler LTV-10XX-G series

6. CHARACTERISTICS CURVES (TYPICAL PERFORMANCE)

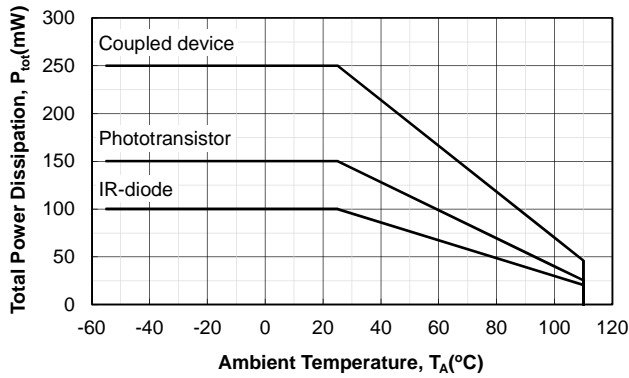

Figure 1. P_{tot} vs. T_A

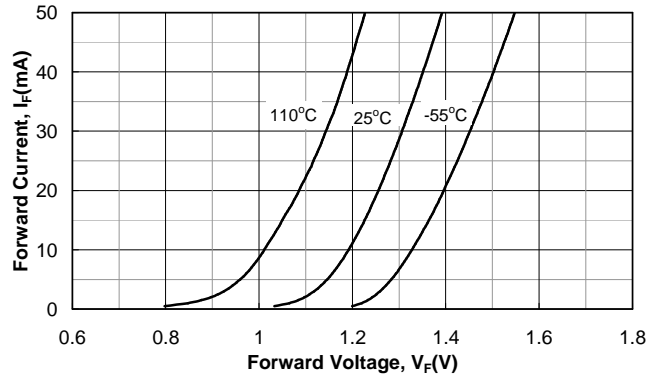

Figure 4. I_F vs. V_F

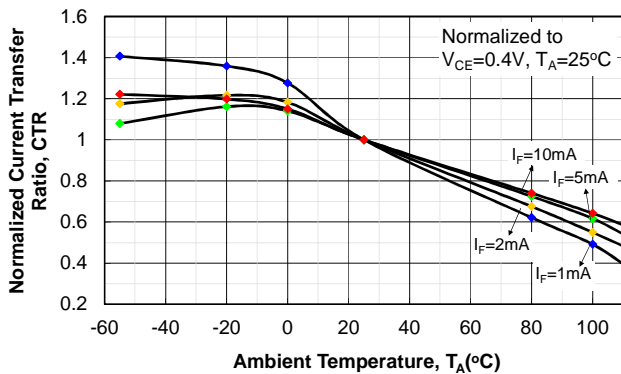

Figure 2. Saturated Normalized CTR vs. T_A

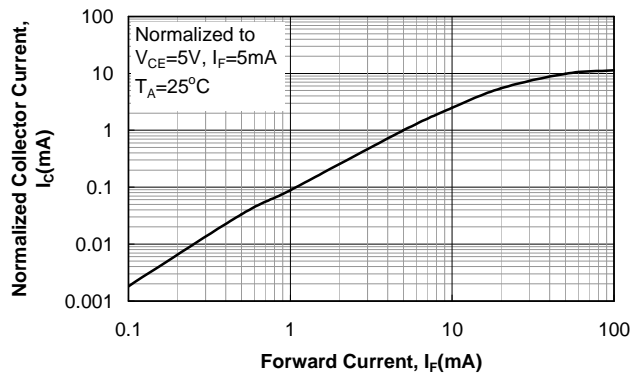

Figure 5. Normalized I_C vs. I_F

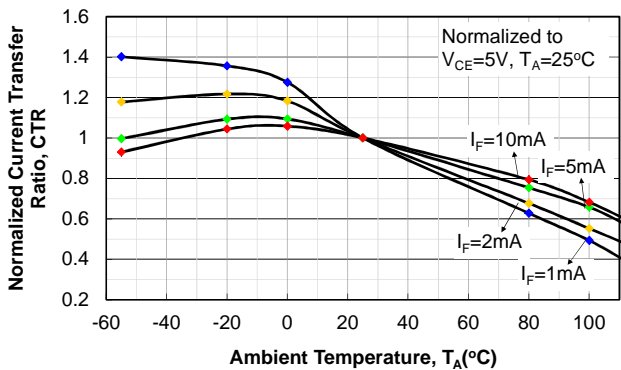

Figure 3. Non-saturated Normalized CTR vs. T_A

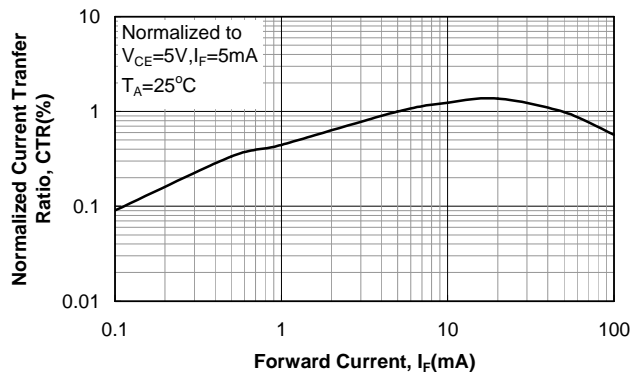

Figure 6. Normalized CTR vs. I_F

Photocoupler LTV-10XX-G series

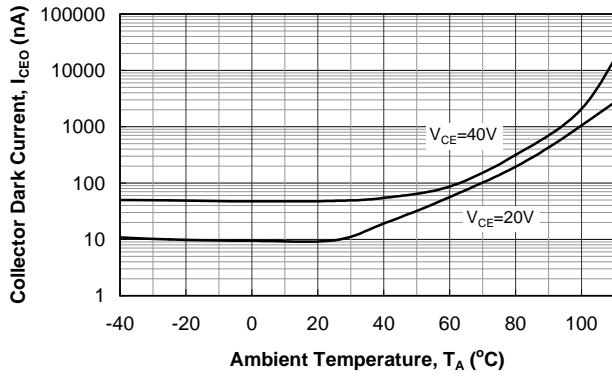

Figure 7. I_{CEO} vs. T_A

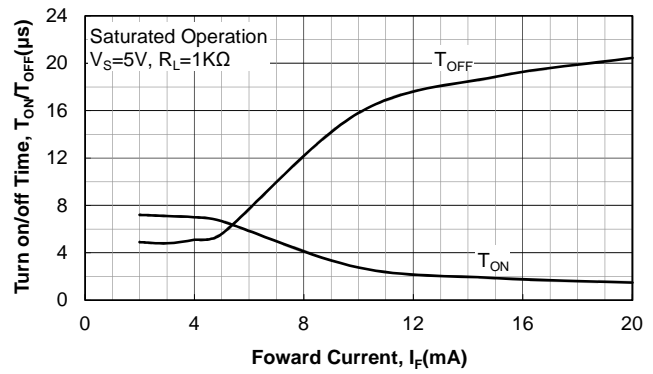

Figure 10. T_{ON} / T_{OFF} vs. I_F

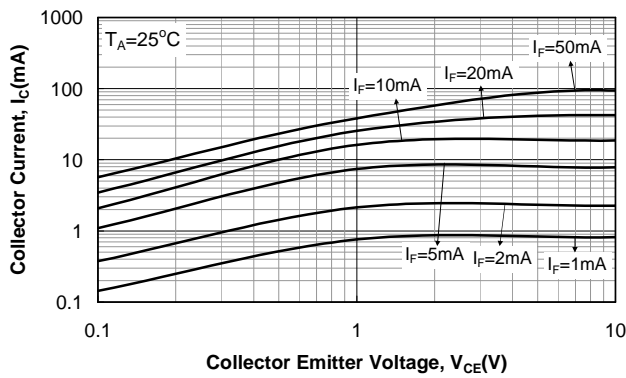

Figure 8. I_C vs. V_{CE}

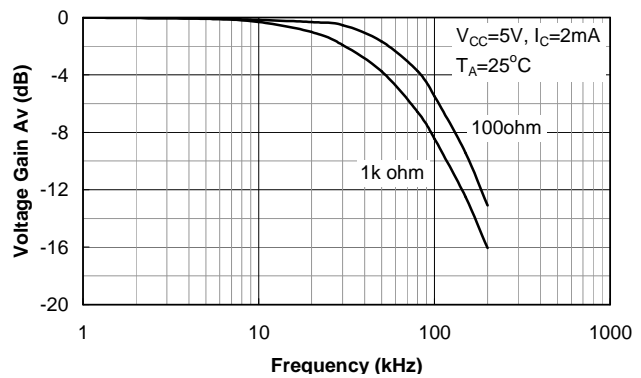

Figure 11. Frequency Response

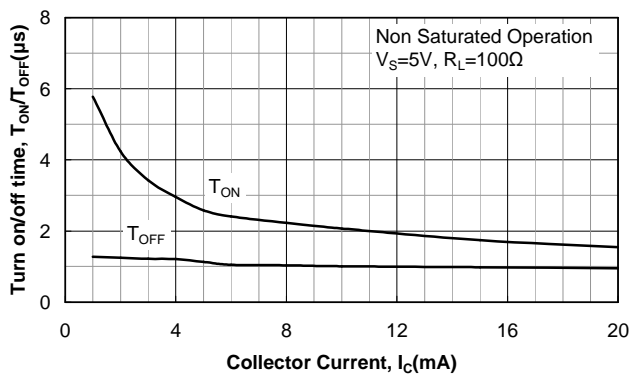

Figure 9. T_{ON} / T_{OFF} vs. I_C

Photocoupler
LTV-10XX-G series

7. TEMPERATURE PROFILE OF SOLDERING

7.1 IR Reflow soldering (JEDEC-STD-020C compliant)

One time soldering reflow is recommended within the condition of temperature and time profile shown below. Do not solder more than three times.

Profile item	Conditions
Preheat	
- Temperature Min (T_{Smin})	150°C
- Temperature Max (T_{Smax})	200°C
- Time (min to max) (ts)	90±30 sec
Soldering zone	
- Temperature (T_L)	217°C
- Time (t_L)	60 sec
Peak Temperature (T_P)	260°C
Ramp-up rate	3°C / sec max.
Ramp-down rate	3~6°C / sec

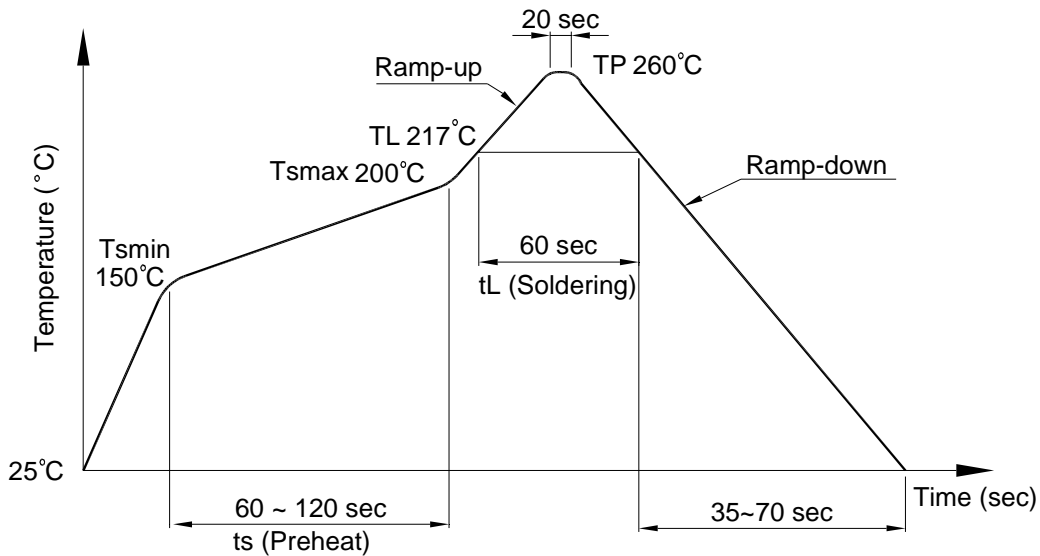

**Photocoupler
LTV-10XX-G series**

7.2 Wave soldering (JEDEC22A111 compliant)

One time soldering is recommended within the condition of temperature.

Temperature: $260 \pm 0 / -5^{\circ}\text{C}$

Time: 10 sec.

Preheat temperature: 25 to 140°C

Preheat time: 30 to 80 sec.

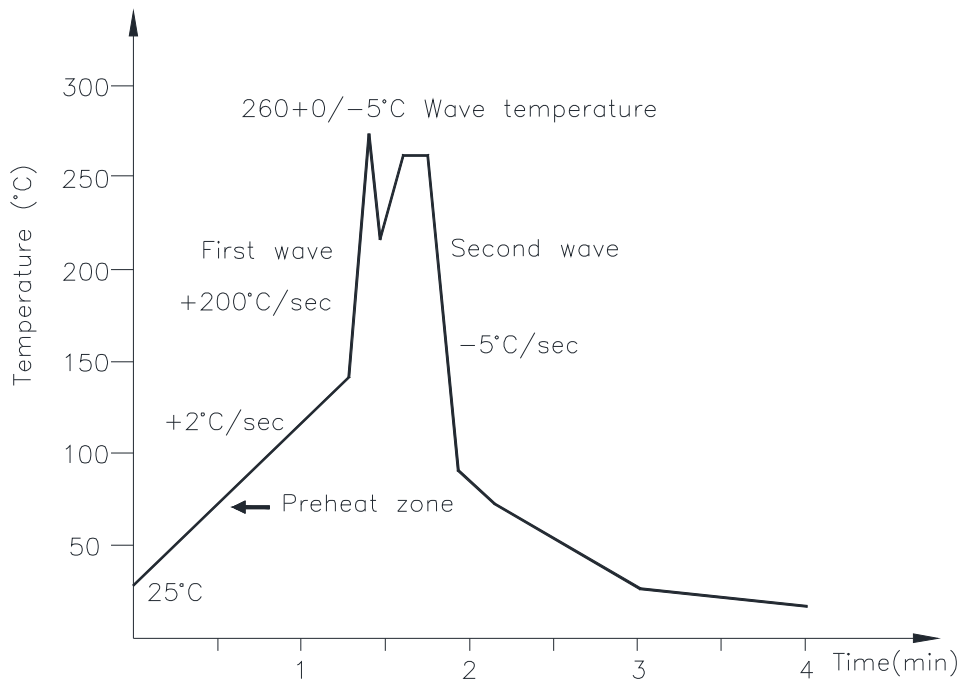

7.3 Hand soldering by soldering iron

Allow single lead soldering in every single process. One time soldering is recommended.

Temperature: $380 \pm 0 / -5^{\circ}\text{C}$

Time: 3 sec max.

**Photocoupler
LTV-10XX-G series**

8. RECOMMENDED FOOT PRINT PATTERNS (MOUNT PAD)

Unit: mm

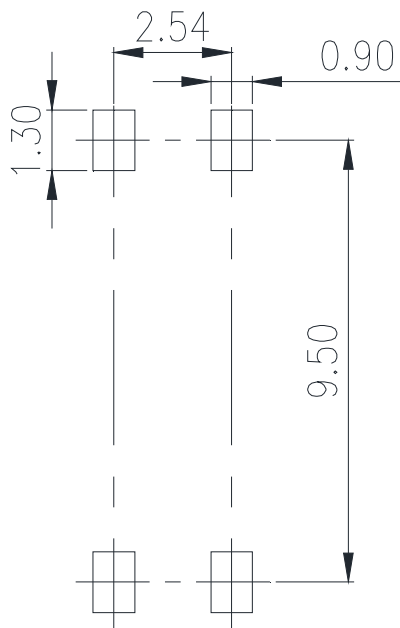

**Photocoupler
LTV-10XX-G series**

9. NAMING RULE

LTV-10XX-(2)-G

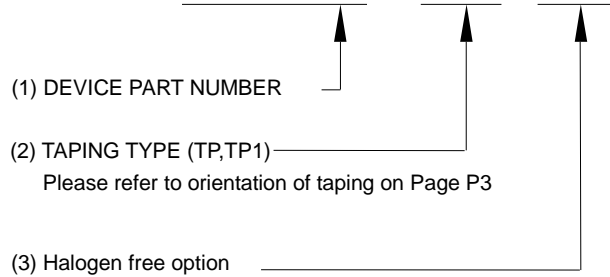

Example : LTV-1008-TP-G

LTV 10XX (2) -V-G

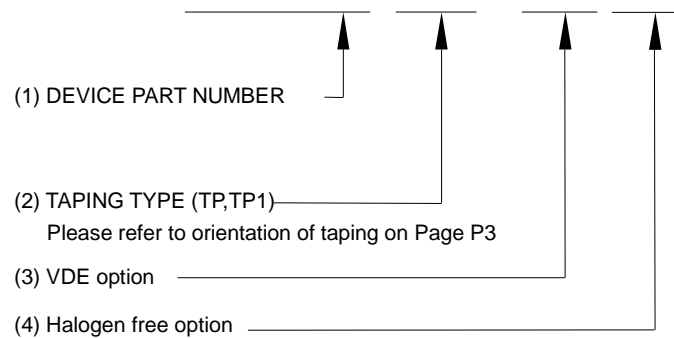

Example : LTV1008TP-V-G

10. NOTES

- LiteOn is continually improving the quality, reliability, function or design and LiteOn reserves the right to make changes without further notices.
- The products shown in this publication are designed for the general use in electronic applications such as office automation equipment, communications devices, audio/visual equipment, electrical application and instrumentation.
- For equipment/devices where high reliability or safety is required, such as space applications, nuclear power control equipment, medical equipment, etc, please contact our sales representatives.
- When requiring a device for any "specific" application, please contact our sales in advice.
- If there are any questions about the contents of this publication, please contact us at your convenience.
- The contents described herein are subject to change without prior notice.
- Immerge unit's body in solder paste is not recommended.

单击下面可查看定价，库存，交付和生命周期等信息

[>>Lite-On\(光宝\)](#)