



Photocoupler
Product Data Sheet
LTV-172G

Spec No. :DS70-2019-0238
Effective Date: 12/10/2019
Revision: -

LITE-ON DCC

RELEASE

BNS-OD-FC001/A4

Photocoupler LTV-172G series

1. DESCRIPTION

The LITEON LTV-172G consists of an aluminum gallium arsenide infrared emitting diode optically coupled to a photo-MOSFET in a SOP4 package, which is suitable for surface mount assembly. The LTV-172G is suitable for the battery management systems which require space savings.

1.1 Features

- Normally open (1-form-A)
- Operating temperature range: 110°C(max)
- Trigger LED current: 3 mA (max)
- Isolation voltage: 3750 Vrms (min)
- OFF-state output terminal voltage : 350V (min)
- ON-state current : 110mA (max)
- ON-state resistance : 35Ω (max)
- Safety standards
 - UL1577
 - CUL CA5A
 - VDE DIN EN60747-5-5 (VDE 0884-5)

1.2 Functional Diagram

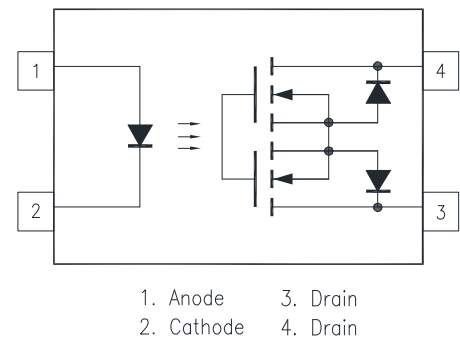

1.3 Applications

- Battery Management System (BMS)
- Factory Automation (FA)
- Security Systems
- Measuring Instruments
- Smart Meters
- Mechanical relay replacements

Photocoupler LTV-172G series

2. PACKAGE DIMENSIONS

2.1 LTV-172G series

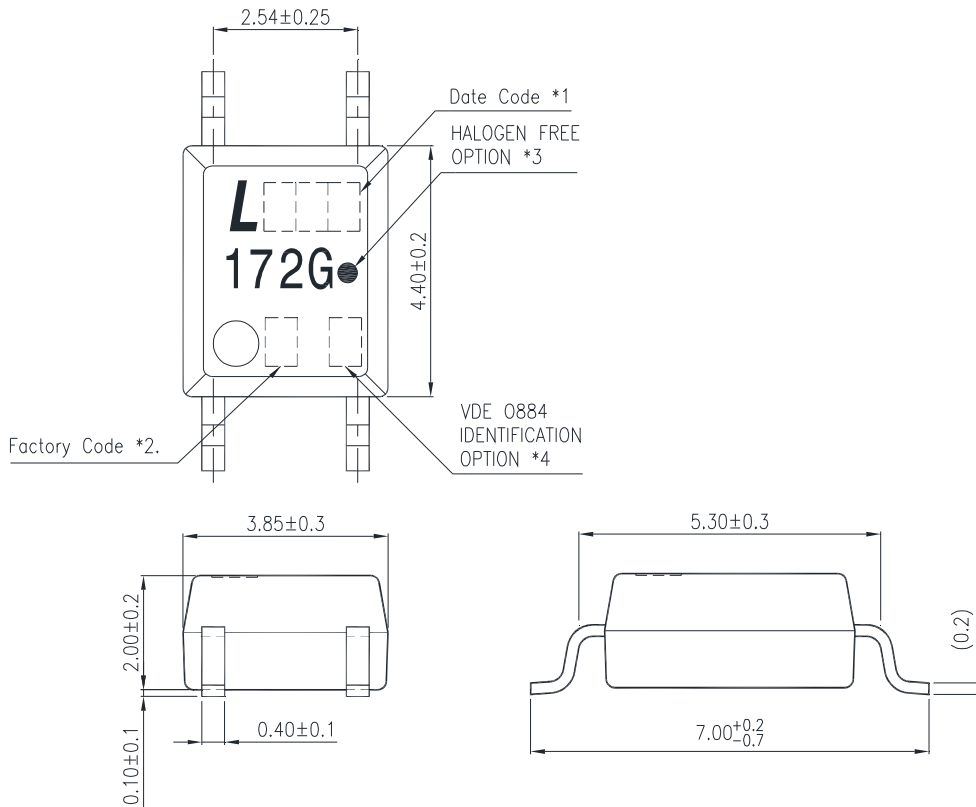

Notes:

- 1-digit year code, Example : 2010 = A
2-digit work week ranging from '01' to '53'
- Factory identification mark shall be marked (W: China -CZ, X: China -TJ)
- "●" indicates halogen free option.
- "4" or "V" for VDE option.

**Photocoupler
LTV-172G series**

3. TAPING DIMENSIONS

3.1 LTV-172G-TP

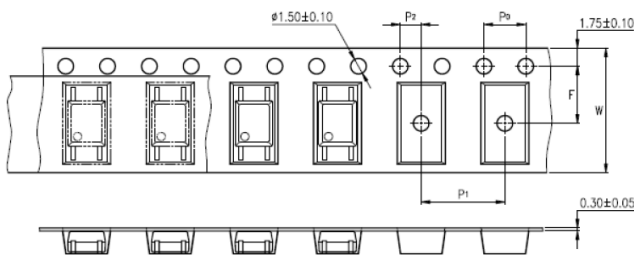

3.2 LTV-172G

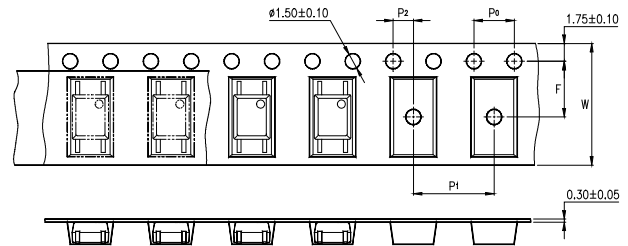

Description	Symbol	Dimension in mm (inch)
Tape wide	W	12±0.3 (0.472)
Pitch of sprocket holes	P ₀	4±0.1 (0.157)
Distance of compartment	F	5.5±0.1 (0.217)
	P ₂	2±0.1 (0.079)
Distance of compartment to compartment	P ₁	8±0.1 (0.315)

3.3 Quantities Per Reel

Package Type	LTV-172G Series
Quantities (pcs)	3000

Photocoupler LTV-172G series

4. RATING AND CHARACTERISTICS

4.1 Absolute Maximum Ratings at Ta=25°C

Parameter		Symbol	Rating	Unit
Input	Forward Current	I_F	50	mA
	Forward Current Derating ($T_A \geq 25^\circ\text{C}$)	$\Delta I_F/^\circ\text{C}$	-0.5	mA/°C
	Peak Forward Current (100 μs pulse, 100pps)	I_{FP}	1	A
	Reverse Voltage	V_R	6	V
	Input Power Dissipation	P_D	70	mW
	Junction Temperature	T_J	125	°C
Output	OFF-State Output Terminal Voltage	V_{OFF}	350	V
	ON-State Current	I_{ON}	110	mA
	ON-State Current Derating ($T_A \geq 25^\circ\text{C}$)	$\Delta I_{ON}/^\circ\text{C}$	-1.1	mA/°C
	ON-State Current (pulsed) ($t=100\text{ms}$, Duty=1/10)	I_{ONP}	0.33	A
	Output Power dissipation	P_O	300	mW
Isolation Voltage (Note 1.)	V_{iso}	3750	V	
Operating Temperature	T_{opr}	-40 ~ +110	°C	
Storage Temperature	T_{stg}	-55 ~ +125	°C	
Soldering Temperature	T_{sol}	260 (For 10 seconds)	°C	

4.2 RECOMMENDED OPERATING CONDITIONS (Note)

Characteristics	Symbol	Min.	Typ.	Max.	Unit
Supply Voltage	V_{DD}	-	-	280	V
Forward Current	I_F	5	7.5	25	mA
On-state Current	I_{ON}	-	-	110	
Operating Temperature	T_{opr}	-20	-	100	°C

Note : The recommended operating conditions are given as a design guide necessary to obtain the intended performance of the device. Each parameter is an independent value. When creating a system design using this device, the electrical characteristics specified in this datasheet should also be considered.

4.3 ELECTRICAL OPTICAL CHARACTERISTICS at Ta=25°C

Photocoupler LTV-172G series

Note :

Parameter		Sym bol	Min.	Typ.	Max.	Unit	Test Condition
Input	Forward Voltage	V_F	1.0	1.18	1.3	V	$I_F=10\text{mA}$
	Reverse Current	I_R	-	-	10	μA	$V_R=5\text{V}$
Out -put	OFF-State Current	I_{OFF}	-	-	100	nA	$V_{OFF}=350\text{V}$
Coupled	Trigger LED Current	I_{FT}	-	0.8	3	mA	$I_{ON}=110\text{mA}$
	Return LED Current	I_{FC}	0.1	0.6	-	mA	$I_{OFF}=100\mu\text{A}$
	On Resistance	R_{on}	-	25	35	Ω	$I_F=5\text{mA}, I_{ON}=110\text{mA}, t<1\text{s}$
-			35	50	Ω	$I_F=5\text{mA}, I_{ON}=110\text{mA}$	
Transfer characteristics	Turn on time (Note 2.)	T_{on}	-	0.15	1	ms	$R_L=200\Omega, V_{DD}=20\text{V}$ $I_F=5\text{mA}$
	Turn off time (Note 2.)	T_{off}	-	0.1	0.5	ms	
	Isolation Resistance	R_{iso}	5×10^{10}	-	-	Ω	DC500V, R.H.40 ~ 60%

- AC For 1 Minute, R.H. = 40 ~ 60%. Isolation voltage shall be measured using the following method.
 - Short between anode and cathode on the primary side and between collector and emitter on the secondary side.
 - The isolation voltage tester with zero-cross circuit shall be used.
 - The waveform of applied voltage shall be a sine wave.
- Turn on / turn off time

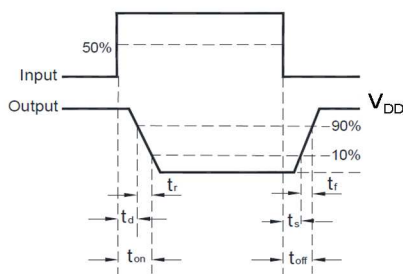

5. CHARACTERISTICS CURVES

Photocoupler LTV-172G series

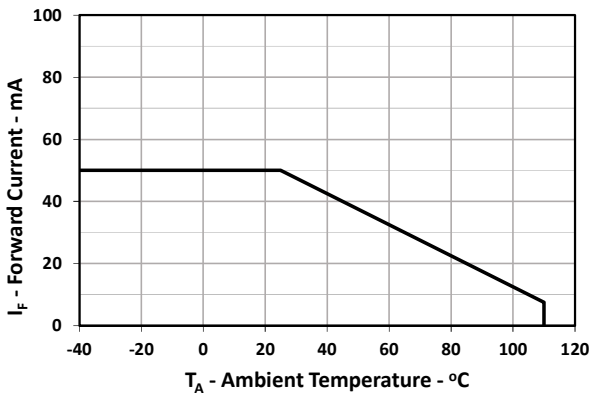

Fig. 1-1 Forward Current vs. Ambient Temperature

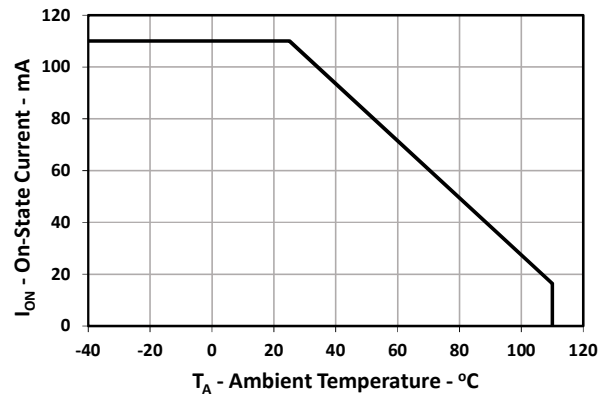

Fig. 1-2 On-State Current vs. Ambient Temperature

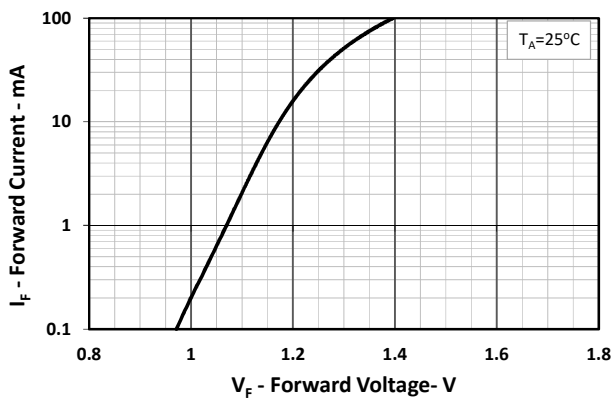

Fig. 2 Forward Current vs. Forward Voltage

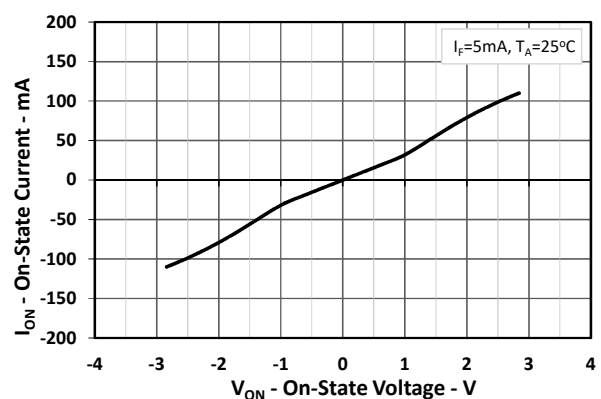

Fig. 3 On-State Current vs. On-State Voltage

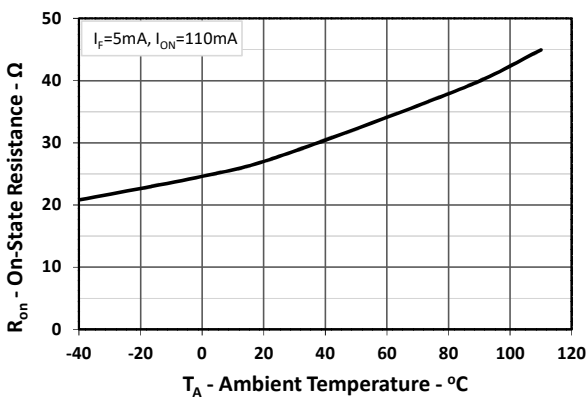

Fig. 4 On-State Resistance vs. Ambient Temperature

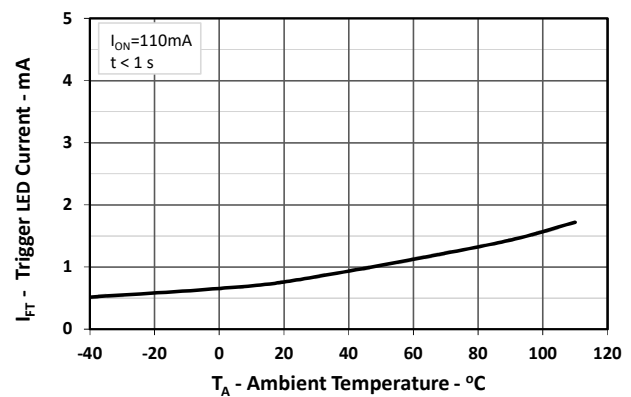

Fig. 5 Trigger LED Current vs. Ambient Temperature

Photocoupler
LTV-172G series

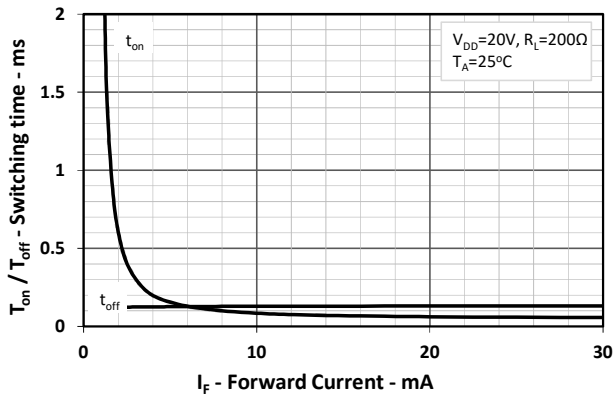

Fig. 6 Switching time vs. Forward Current

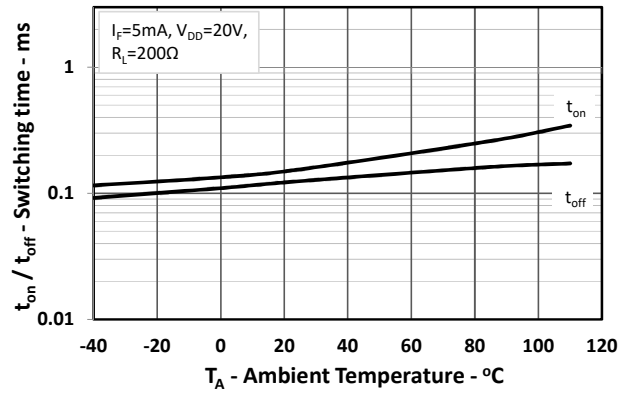

Fig. 7 Switching time vs. Ambient Temperature

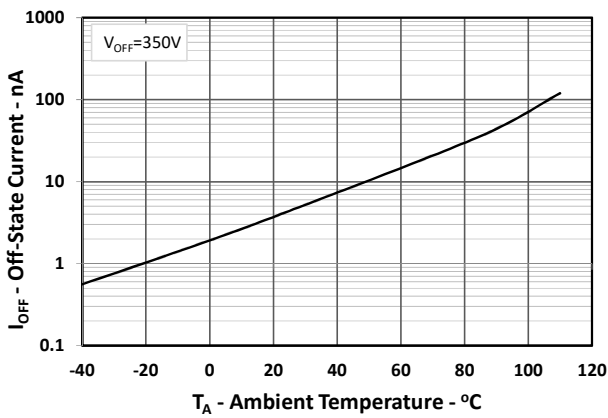

Fig. 8 Off-State Current vs. Ambient Temperature

Photocoupler LTV-172G series

6. TEMPERATURE PROFILE OF SOLDERING

6.1 IR Reflow soldering (JEDEC-STD-020E compliant)

One time soldering reflow is recommended within the condition of temperature and time profile shown below. Do not solder more than twice

Profile item	Conditions
Preheat	
- Temperature Min (T_{Smin})	150°C
- Temperature Max (T_{Smax})	200°C
- Time (min to max) (ts)	90±30 sec
Soldering zone	
- Temperature (T_L)	217°C
- Time (t_L)	60 sec
Peak Temperature (T_P)	260°C
Ramp-up rate	3°C / sec max.
Ramp-down rate	3~6°C / sec

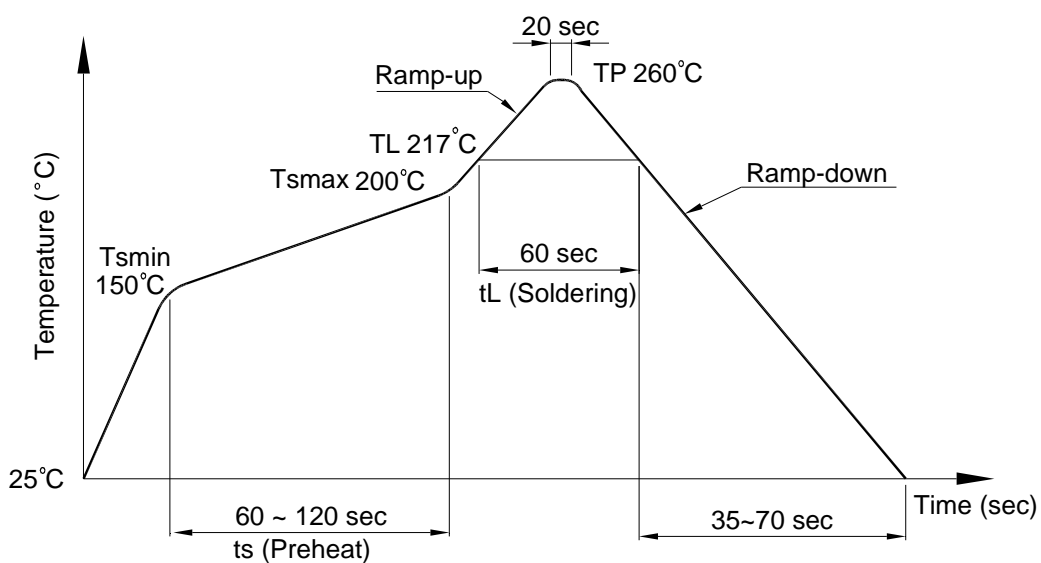

Photocoupler LTV-172G series

6.2 Wave soldering (JEDEC22A111 compliant)

One time soldering is recommended within the condition of temperature.

Temperature: $260 \pm 0 / -5^{\circ}\text{C}$

Time: 10 sec.

Preheat temperature: 25 to 140°C

Preheat time: 30 to 80 sec.

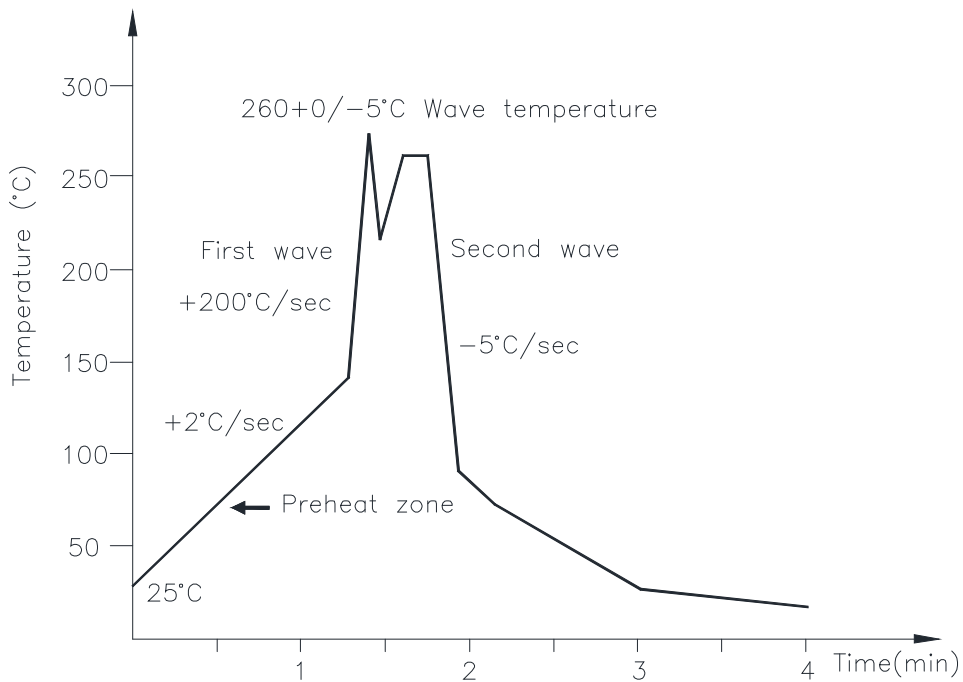

6.3 Hand soldering by soldering iron

Allow single lead soldering in every single process. One time soldering is recommended.

Temperature: $380 \pm 0 / -5^{\circ}\text{C}$

Time: 3 sec max.

**Photocoupler
LTV-172G series**

7. NAMING RULE

LTV-172G-(1)-G

DEVICE PART NUMBER

(1) TAPING TYPE (TP, no suffix)

LTV-172G has tape and reel solution.

Please refer to orientation of taping on Page.3

(2) Halogen free option

Example : LTV-172G-TP-G

LTV172G(1)-V-G

DEVICE PART NUMBER

(1) TAPING TYPE (TP, no suffix)

LTV-172G has tape and reel solution.

Please refer to orientation of taping on Page.3

(2) VDE option

(3) Halogen free option

Example : LTV172GTP-V-G

8. NOTES

- LiteOn is continually improving the quality, reliability, function or design and LiteOn reserves the right to make changes without further notices.
- The products shown in this publication are designed for the general use in electronic applications such as office automation equipment, communications devices, audio/visual equipment, electrical application and instrumentation.
- For equipment/devices where high reliability or safety is required, such as space applications, nuclear power control equipment, medical equipment, etc, please contact our sales representatives.
- When requiring a device for any "specific" application, please contact our sales in advice.
- If there are any questions about the contents of this publication, please contact us at your convenience.
- The contents described herein are subject to change without prior notice.
- Immerge unit's body in solder paste is not recommended.

单击下面可查看定价，库存，交付和生命周期等信息

[>>Lite-On\(光宝\)](#)