



Photocopier Product Data Sheet LTV-50L series

Spec No.: DS70-2015-0058

Effective Date: 03/22/2016

Revision: B

LITE-ON DCC

RELEASE

BNS-OD-FC001/A4

Photocoupler LTV-50L series

1. DESCRIPTION

The LTV-50L series consists of a high efficient AlGaAs Light Emitting Diode and a high speed optical detector. This design provides excellent AC and DC isolation between the input and output sides of the Optocoupler. The output of the optical detector features an open collector Schottky clamped transistor. The internal shield ensures high common mode transient immunity. A guaranteed common mode transient immunity is up to 15KV/ μ s (min.). The Optocoupler operational parameters are guaranteed over the temperature range from -55°C ~ +100°C.

1.1 Features

- Stretched SO6
- High speed – 1MBd typical
- Package creepage at 8mm
- Compatible with infrared vapor phase reflow and wave soldering process
- Very high common mode transient immunity: 15K V/ μ s at VCM = 1500 V guaranteed
- Guarantee performance from temperature range: -55°C to 100°C
- TTL compatible
- Open collector output
- Safety approval :
 - UL 1577 recognized with 5000 V_{rms} for 1 minute for LTV-50LP and LTV-50LW
 - VDE DIN EN 60747-5-5 Approved
 - VIORM = 891V_{peak} for LTV-50LP
 - VIORM = 1140V_{peak} for LTV-50LW

1.2 Applications

- Digital signal isolation
- Communications interface
- Micro-controller interface
- Feedback elements in switching power supplies
- Digital isolation for A/D, D/A conversion Digital field

Functional Diagram

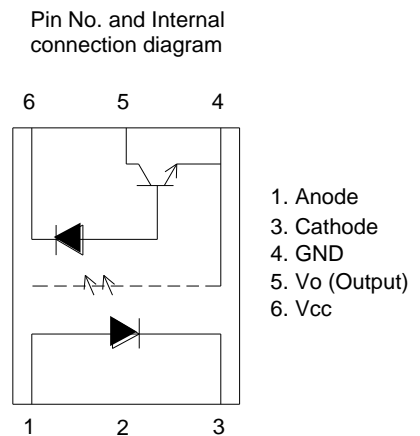

A 0.1 μ F bypass Capacitor must be connected between Pin 4 and 6. *1

Truth Table (Positive Logic)

LED	OUT
ON	LOW
OFF	HIGH

Photocoupler LTV-50L series

2. PACKAGE DIMENSIONS

2.1 LTV-50LW

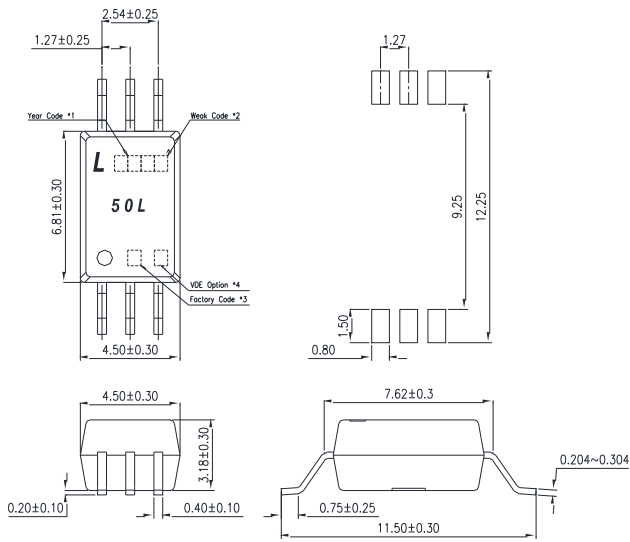

2.2 LTV-50LP

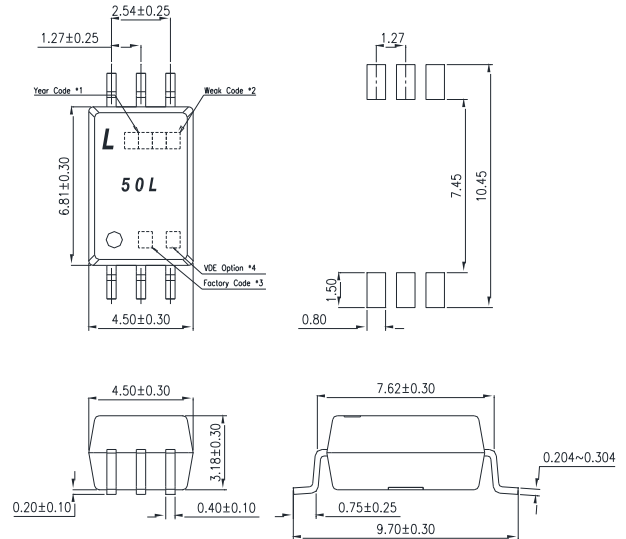

Notes :

1. Year date code.
2. 2-digit work week.
3. Factory identification mark (Y : Thailand).
4. "4" or "V" for VDE option.

* Dimensions are in Millimeters and (Inches).

Photocoupler LTV-50L series

3. TAPING DIMENSIONS

3.1 LTV-50LW-TA

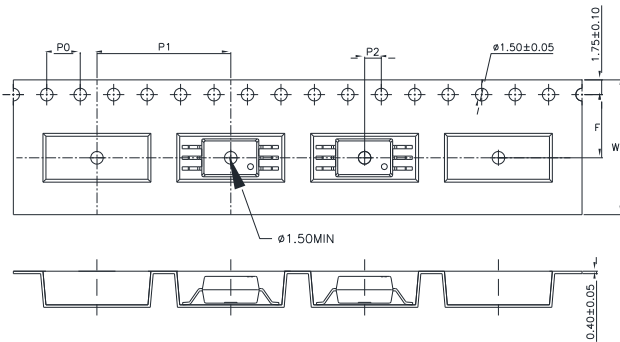

3.2 LTV-50LW-TA1

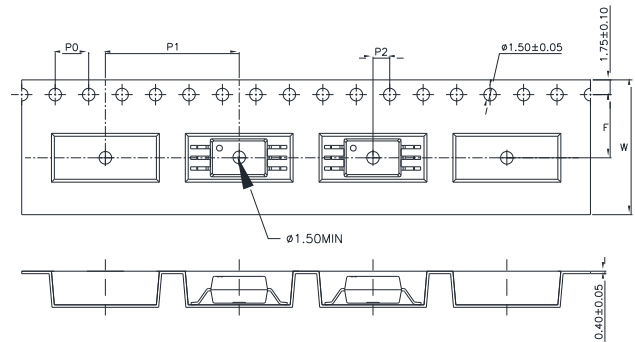

3.3 LTV-50LP-TA

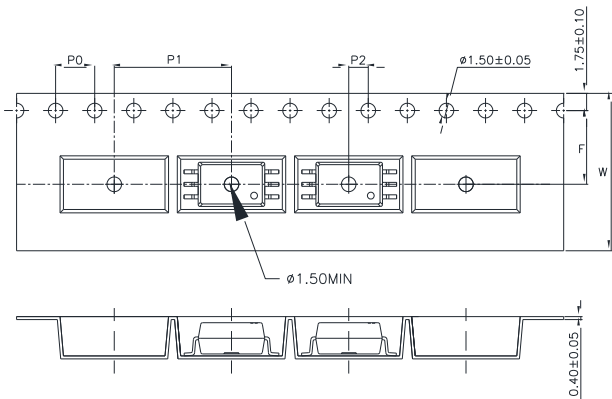

3.4 LTV-50LP-TA1

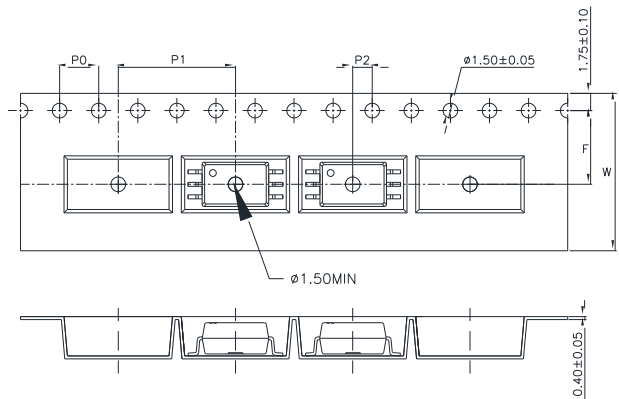

Description	Symbol	Dimension in mm (inch)	
		For W type	For P type
Tape wide	W	16±0.3 (0.63)	16±0.3 (0.63)
Pitch of sprocket holes	P_0	4±0.1 (0.16)	4±0.1 (0.16)
Distance of compartment	F	7.5±0.1 (0.3)	7.5±0.1 (0.3)
	P_2	2±0.1 (0.079)	2±0.1 (0.079)
Distance of compartment to compartment	P_1	16±0.1 (0.63)	12±0.1 (0.47)

3.5 Quantities Per Reel

Package Type	LTV-50L series
Quantities (pcs)	1000

Photocoupler LTV-50L series

4. RATING AND CHARACTERISTICS

4.1 Absolute Maximum Ratings

Parameter	Symbol	Min	Max	Units	Note
Storage Temperature	T_{ST}	-55	125	°C	—
Operating Temperature	T_A	-55	100	°C	—
Isolation Voltage	V_{ISO}	5000	—	V_{RMS}	—
Supply Voltage	V_{CC}	-0.5	30	V	—
Lead Solder Temperature	—	—	260	°C	2
Input					
Average Forward Input Current	I_F	—	25	mA	—
Peak Input Current (50% duty cycle, 1 ms pulse width)	I_F	—	50	mA	3
Peak Transient Input Current (1 μ s pulse width, 300 pps)	I_F	—	1.0	A	—
Reverse Input Voltage	V_R	—	5	V	—
Input Power Dissipation	P_I	—	45	mW	—
Output					
Output Collector Current	I_O	—	8	mA	—
Peak Output Current	I_O	—	16	mA	—
Output Collector Voltage	V_O	-0.5	20	V	—
Output Collector Power Dissipation	P_O	—	100	mW	—

*Ambient temperature = 25°C, unless otherwise specified. Stresses exceeding the absolute maximum ratings can cause permanent damage to the device. Exposure to absolute maximum ratings for long periods of time can adversely affect reliability.

Photocoupler LTV-50L series

4.2 Electrical Optical Characteristics

Parameters	Test Condition	Symbol	Min	Typ	Max	Units	Note
Input							
Input Forward Voltage	$I_F = 16\text{mA}$, $T_A = 25^\circ\text{C}$	V_F	1.2	1.4	1.8	V	—
Input Reverse Voltage	$I_R = 10\mu\text{A}$	BV_R	5	—	—	V	—
Detector							
* Current transfer ratio	$I_F = 16\text{mA}$; $V_{CC} = 4.5\text{V}$; $T_A = 25^\circ\text{C}$; $V_O = 0.4\text{V}$	CTR	20	32	—	%	—
	$I_F = 16\text{mA}$; $V_{CC} = 4.5\text{V}$; $T_A = 25^\circ\text{C}$; $V_O = 0.5\text{V}$		15	33	—		
Logic low output voltage output voltage	$I_F = 16\text{mA}$; $V_{CC} = 4.5\text{V}$; $I_O = 3.0\text{mA}$; $T_A = 25^\circ\text{C}$	V_{OL}	—	0.2	0.4	V	—
	$I_F = 16\text{mA}$; $V_{CC} = 4.5\text{V}$; $I_O = 2.4\text{mA}$; $T_A = 25^\circ\text{C}$		—	—	0.5		
Logic high output current	$I_F = 0\text{mA}$, $V_O = V_{CC} = 5.5\text{V}$, $T_A = 25^\circ\text{C}$	I_{OH}	—	0.002	0.5	μA	—
	$I_F = 0\text{mA}$, $V_O = V_{CC} = 15\text{V}$ $T_A = 25^\circ\text{C}$		—	0.005	1		
	$T_A = 0 \sim 70^\circ\text{C}$		—	—	50		
Logic low supply current	$I_F = 16\text{mA}$, $V_O = \text{open}$ ($V_{CC} = 30\text{V}$)	I_{CCL}	—	165	—	—	—
Logic high supply current	$I_F = 0\text{mA}$, $V_O = \text{open}$; $T_A = 25^\circ\text{C}$ ($V_{CC} = 30\text{V}$)	I_{CCH}	—	0.002	1	—	—

*All Typical values at $T_A = 25^\circ\text{C}$ unless otherwise specified. All minimum and maximum specifications are at recommended operating condition.

*Current Transfer Ratio in percent is defined as the ratio of output collector current, I_O , to the forward LED input current, I_F , times 100%.

Photocoupler LTV-50L series

5. SWITCHING SPECIFICATION

Parameter	Test Condition	Symbol	Min	Typ	Max	Units	Note
Propagation Delay Time to Low Output Level	$T_A = 25^\circ\text{C}$	t_{PHL}	—	190	800	ns	5
	0 ~ 100°C		—	—	800		
Propagation Delay Time to High Output Level	$T_A = 25^\circ\text{C}$	t_{PLH}	—	150	800	ns	4
	0 ~ 100°C		—	—	800		
Logic High Common Mode Transient Immunity	$I_F = 0\text{mA}; V_{\text{CM}} = 1500\text{Vp-p};$ $C_L = 15\text{ pF}; T_A = 25^\circ\text{C},$ $R_L = 1.9\text{K}\Omega$	$ CM_H $	15	25	—	KV/ μs	6
Logic Low Common Mode Transient Immunity	$I_F = 16\text{mA}; V_{\text{CM}} = 1500\text{Vp-p}$ $C_L = 15\text{ pF}; T_A = 25^\circ\text{C},$ $R_L = 1.9\text{K}\Omega$	$ CM_L $	15	25	—	KV/ μs	7

*All Typical values at $T_A = 25^\circ\text{C}$ unless otherwise specified. All minimum and maximum specifications are at recommended operating condition.

Photocoupler LTV-50L series

6. ISOLATION CHARACTERISTIC

Parameter	Test Condition	Symbol	Min	Typ	Max	Units	Note
Input-Output Insulation Leakage Current	45% RH, t = 5s, V _{I-O} = 3kV DC, T _A = 25°C	I _{I-O}	—	—	1.0	μA	8
Withstand Insulation Test Voltage	RH ≤ 50%, t = 1min, T _A = 25°C	V _{ISO}	5000	—	—	V _{rms}	8,9
Input-Output Resistance	V _{I-O} = 500V DC	R _{I-O}	—	10 ¹²	—	Ω	8

*All Typical values at T_A = 25°C unless otherwise specified. All minimum and maximum specifications are at recommended operating condition.

NOTES:

- 1) A 0.1μF or bigger bypass capacitor for V_{CC} is needed.
- 2) 260°C for 10 seconds
- 3) Peaking driving circuit may be used to speed up the LED. The peak drive current of LED may go up to 50mA and maximum pulse width 50ns, as long as average current doesn't exceed 20mA.
- 4) t_{PLH} (propagation delay) is measured from the 3.75 mA point on the falling edge of the input pulse to the 1.5 V point on the rising edge of the output pulse.
- 5) t_{PHL} (propagation delay) is measured from the 3.75 mA point on the rising edge of the input pulse to the 1.5 V point on the falling edge of the output pulse.
- 6) CM_H is the maximum tolerable rate of rise of the common mode voltage to assure that the output will remain in a high logic state
- 7) CM_L is the maximum tolerable rate of fall of the common mode voltage to assure that the output will remain in a low logic state
- 8) Device is considered a two-terminal device: pins 1, 2, 3 shorted together, and pins 4, 5, 6 shorted together.
- 9) In accordance with UL1577, each optocoupler is proof tested by applying an insulation test voltage 6000 V_{rms} for one second (leakage current less than 10 uA).

Photocoupler LTV-50L series

7. TYPICAL PERFORMANCE CURVES & TEST CIRCUITS

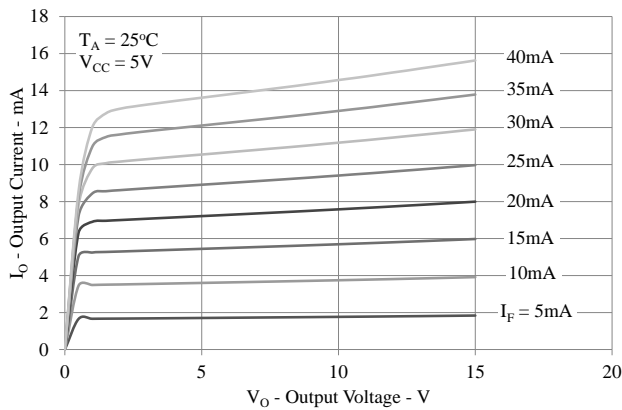

Figure 1: DC and Pulsed Transfer Characteristics

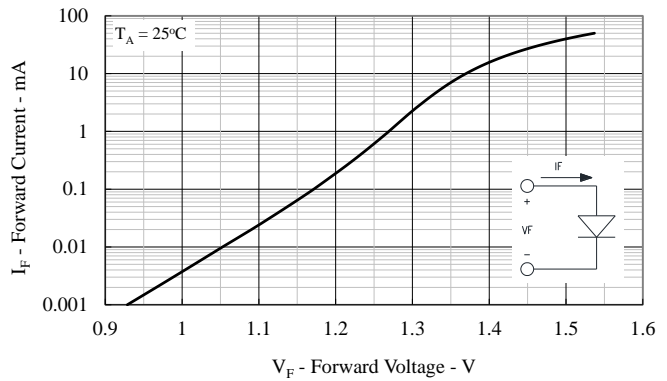

Figure 2: Input Current vs. Forward Voltage

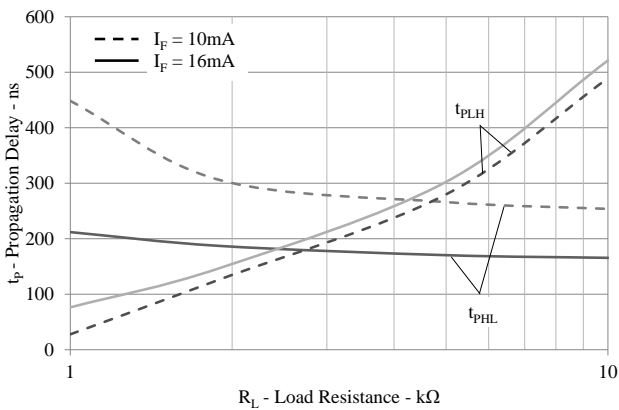

Figure 3: Propagation Delay vs. Load Resistance.

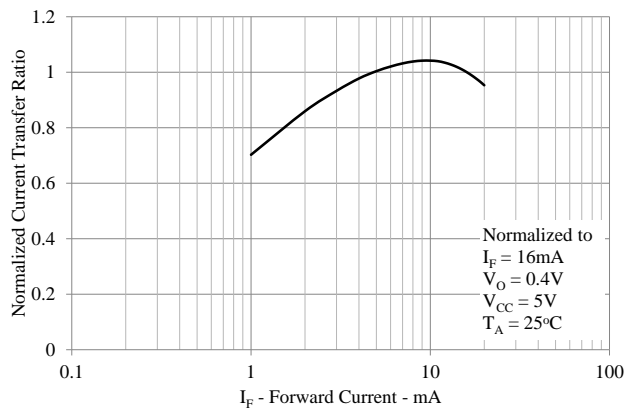

Figure 4: Current Transfer Ratio vs. Input Current.

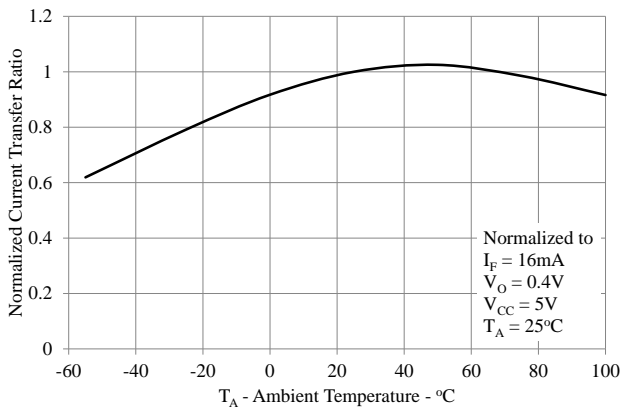

Figure 5: Current Transfer Ratio vs. Temperature.

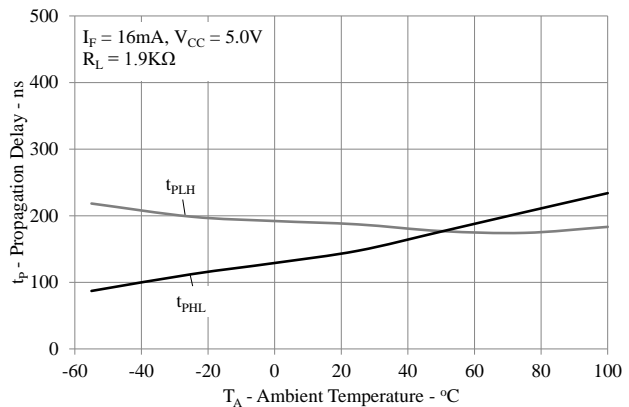

Figure 6: Propagation Delay Time vs. Temperature.

Photocoupler LTV-50L series

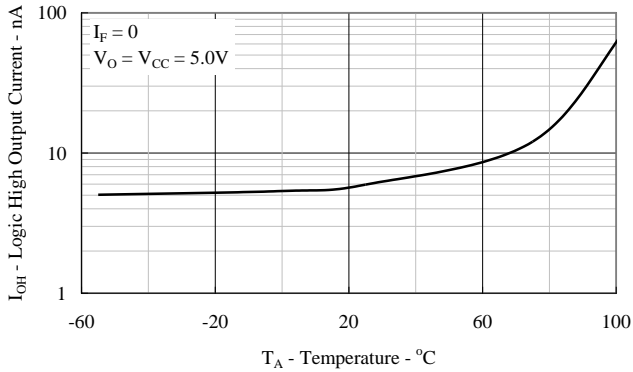

Figure 7: Logic High Output Current vs. Temperature.

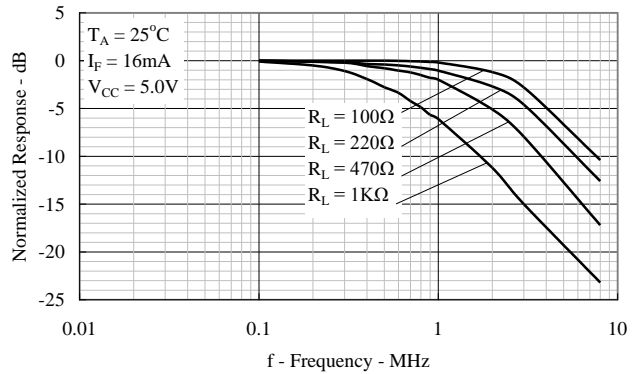

Figure 8: Frequency Response

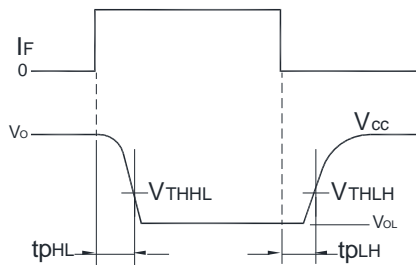

Figure 9: Switching Test Circuit

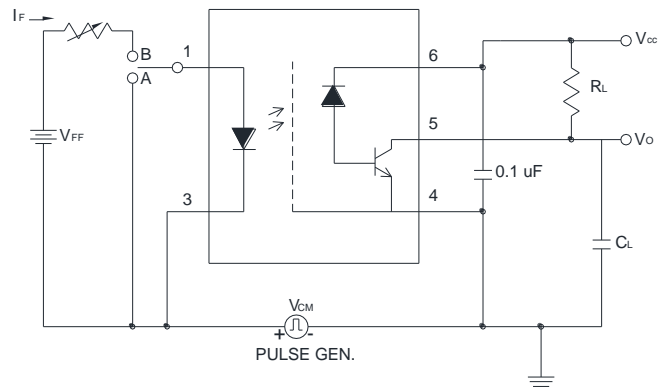
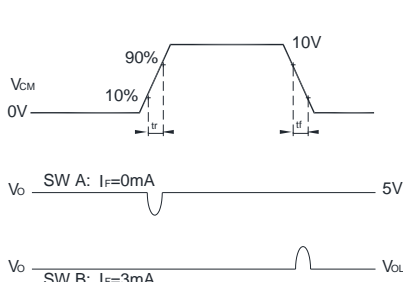
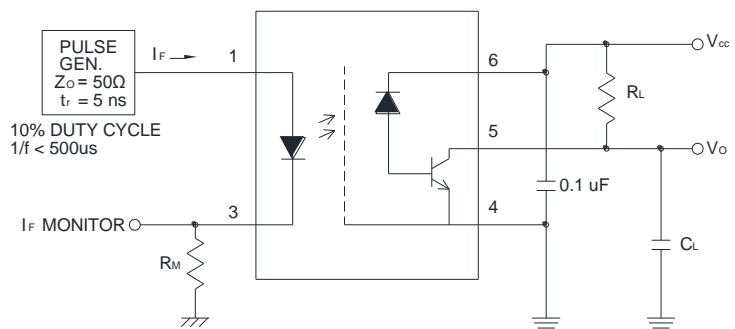

Figure 10: Test Circuit for Transient Immunity and Typical Waveforms

Photocoupler LTV-50L series

8. TEMPERATURE PROFILE OF SOLDERING

8.1 IR Reflow soldering (JEDEC-STD-020C compliant)

One time soldering reflow is recommended within the condition of temperature and time profile shown below. Do not solder more than three times.

Profile item	Conditions
Preheat	
- Temperature Min (T_{Smin})	150°C
- Temperature Max (T_{Smax})	200°C
- Time (min to max) (ts)	90±30 sec
Soldering zone	
- Temperature (T_L)	217°C
- Time (t_L)	60 ~ 100 sec
Peak Temperature (T_P)	260°C
Ramp-up rate	3°C / sec max.
Ramp-down rate	3~6°C / sec

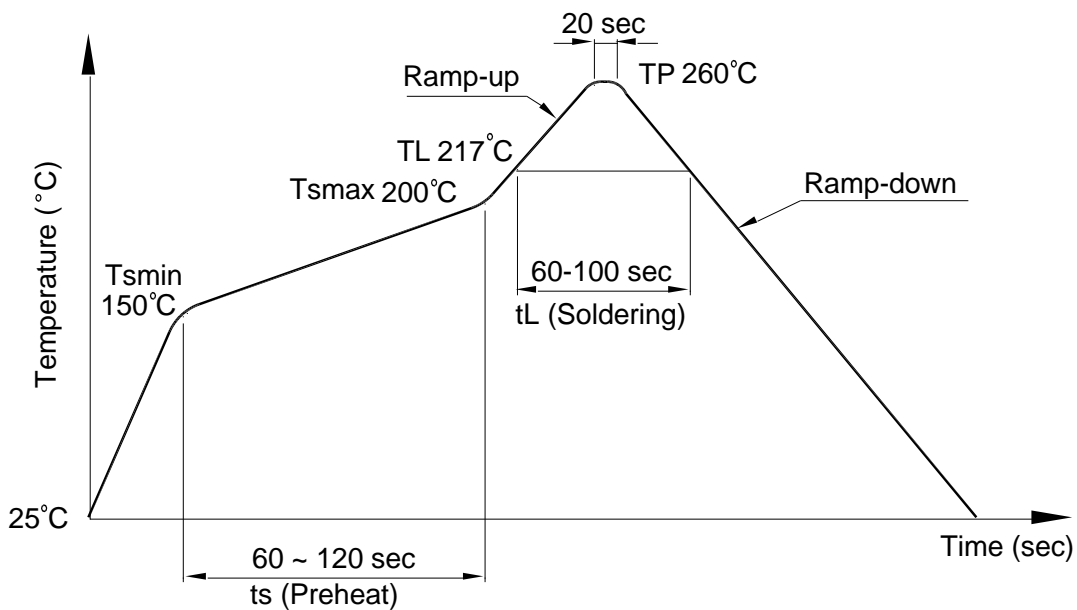

**Photocoupler
LTV-50L series**

8.2 Wave soldering (JEDEC22A111 compliant)

One time soldering is recommended within the condition of temperature.

Temperature: $260 \pm 0 / -5^{\circ}\text{C}$

Time: 10 sec.

Preheat temperature: 25 to 140°C

Preheat time: 30 to 80 sec.

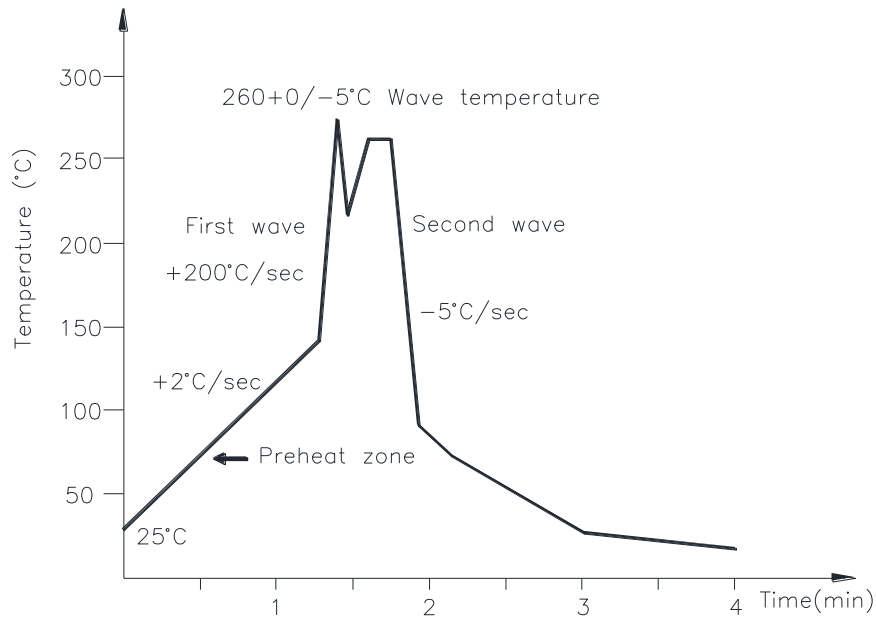

8.3 Hand soldering by soldering iron

Allow single lead soldering in every single process. One time soldering is recommended.

Temperature: $380 \pm 0 / -5^{\circ}\text{C}$

Time: 3 sec max.

**Photocoupler
LTV-50L series**

9. NAMING RULE

Part number Options
LTV-50LP-TA
LTV-50LP-TA1
LTV-50LW-TA
LTV-50LW-TA1
LTV50LPTA-V
LTV50LPTA1-V
LTV50LWTA-V
LTV50LWTA1-V

Definition of Suffix	Remark
"50L"	LiteOn model name
"P"	clearance distance 7mm minimum
"W"	clearance distance 8mm minimum
"TA"	Pin 1 location at lower right of the tape
"TA1"	Pin 1 location at upper left of the tape
"V"	VDE approved option

10. NOTES

- LiteOn is continually improving the quality, reliability, function or design and LiteOn reserves the right to make changes without further notices.
- The products shown in this publication are designed for the general use in electronic applications such as office automation equipment, communications devices, audio/visual equipment, electrical application and instrumentation.
- For equipment/devices where high reliability or safety is required, such as space applications, nuclear power control equipment, medical equipment, etc, please contact our sales representatives.
- When requiring a device for any "specific" application, please contact our sales in advice.
- If there are any questions about the contents of this publication, please contact us at your convenience.
- The contents described herein are subject to change without prior notice.
- Immerge unit's body in solder paste is not recommended.

单击下面可查看定价，库存，交付和生命周期等信息

[>>Lite-On\(光宝\)](#)