



Photocoupler
Product Data Sheet
LTV-8212

Spec No. :DS70-2018-0141
Effective Date: 11/02/2018
Revision: -

LITE-ON DCC

RELEASE

BNS-OD-FC001/A4

Photocoupler LTV-821X series

1. DESCRIPTION

PhotoMOS Relay are integration of an AlGaAs Light Emitting Diode, a Photo Voltage Generator and two MOSFET. These devices are ideally suited for controlling low-level signals and various types of loads, for example relays, motors, lamps and solenoids. PhotoMOS Relay provide 5,000V isolation (Viso(rms)) between input to output.

1.1 Features

- Controls low-level analog signals
- Controls various types of loads such as relays, motors, lamps and solenoids
- Stable on-resistance
- Low-level off state leakage current of max 1uA
- Isolation voltage between input and output Viso : 5,000 Vrms
- Package : DIP4-pin
- Safety approval
Pending

1.2 Applications

- High-speed inspection machines
- Telephone equipment
- Data communication equipment
- Computers

1.3 Functional Diagram

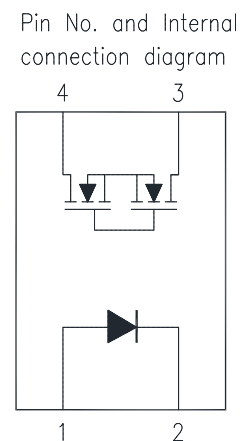

2. TYPES

Output Rating		Part number	Suffix Option			Quantity	
Load Voltage	Load Current		Lead Frame Type *1	Tape & Reel *2	IEC/EN/DIN EN 60747-5-5		Halogen free option
60V	550mA	LTV-8212	LTV-821X	-TA	-V	-G	1000 per reel
250V	180mA	LTV-8217	LTV-821XM				
400V	120mA	LTV-8214	LTV-821XS				
600V	50mA	LTV-8216	-	-TA1			65 per tube

Example :LTV-8212S-TA-G

LTV8212STA-V-G (All "-" should be removed before "-V")

Note :

1. Referring to Page.2
2. The orientation of Pin1 on tape : "-TA" represents lower right ; "-TA1" represents upper left.

Photocoupler LTV-821X series

3. PACKAGE DIMENSIONS

3.1 LTV-821X

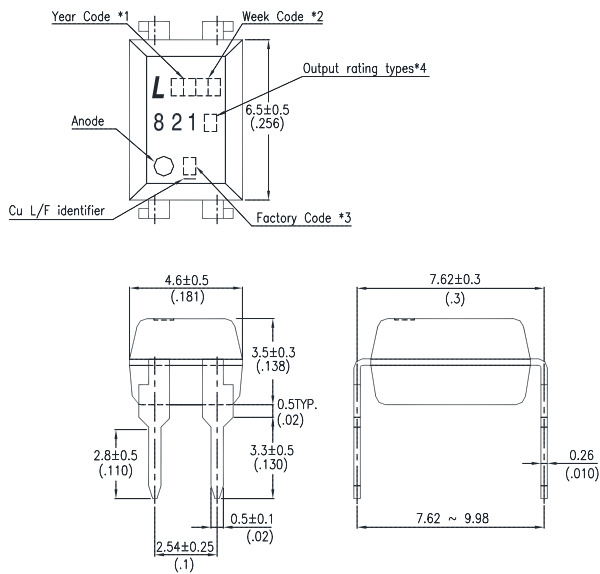

3.2 LTV-821XM

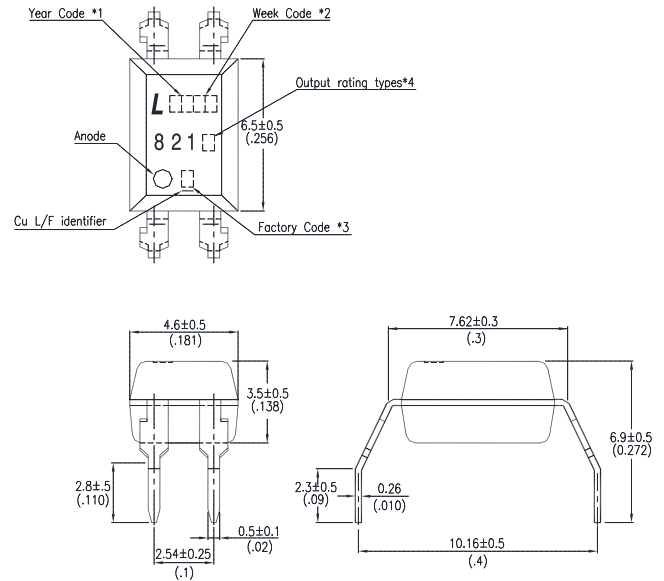

3.3 LTV-821XS

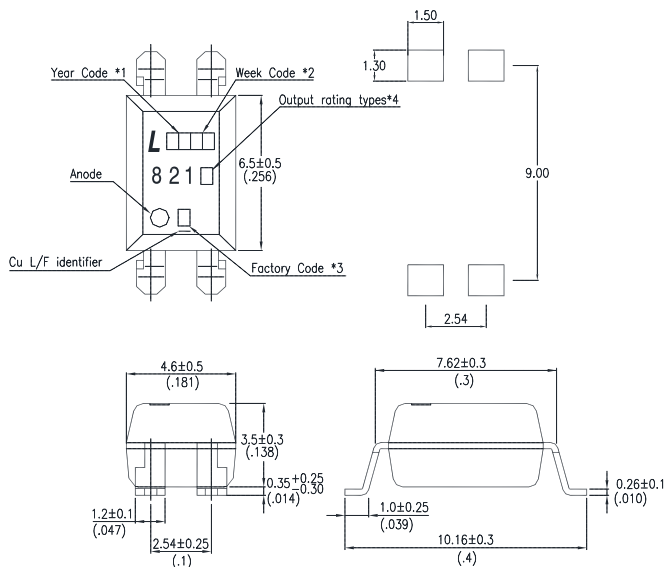

Notes:

1. 2-digit year code, example : 2017 = 17
 2. 2-digit work week ranging from '01' to '52'
 3. Factory identification mark shall be marked (W: China-CZ, Y: Thailand)
 4. VDE option.
 5. Output rating Option
- Dimensions in millimeters (inches).

Photocoupler LTV-821X series

4. TAPING DIMENSIONS

4.1 LTV-821XS-TA

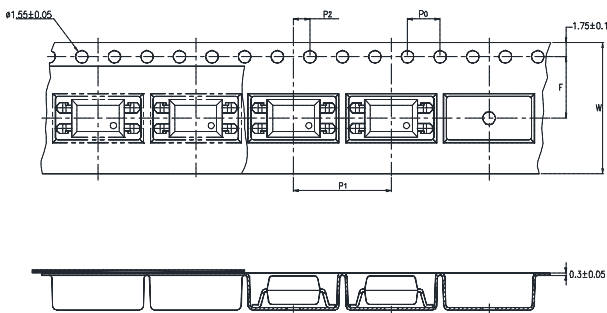

4.2 LTV-821XS-TA1

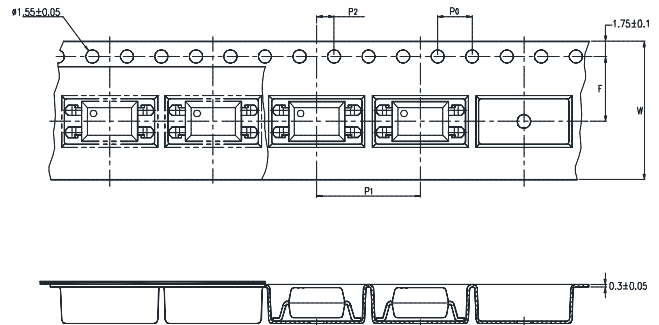

Description	Symbol	Dimension in mm (inch)
Tape wide	W	16±0.3 (0.63)
Pitch of sprocket holes	P ₀	4±0.1 (0.15)
Distance of compartment	F	7.5±0.1 (0.295)
	P ₂	2±0.1 (0.079)
Distance of compartment to compartment	P ₁	12±0.1 (0.47)

4.3 Quantities Per Reel

Package Type	TA/TA1
Quantities (pcs)	1000

Photocoupler LTV-821X series

5. RATING AND CHARACTERISTICS

5.1 Absolute Maximum Ratings at Ta=25°C

Parameter		Symbol	LTV-8212	LTV-8217	LTV-8214	LTV-8216
Input	Forward Current	I_F	50mA			
	Reverse Voltage	V_R	5V			
	Power Dissipation	P_{in}	65 mw			
Output	Load Voltage (peak AC & DC)	V_L	60V	250V	400V	600V
	Continuous load current	I_L	550mA	180mA	120mA	50mA
	Power dissipation	P_{out}	500mW			
	Total Power Dissipation	P_{tot}	550mW			
1.	Isolation Voltage	V_{iso}	5000V			
	Operating Temperature	T_{opr}	-40 ~ +85 °C			
	Storage Temperature	T_{stg}	-55 ~ +125 °C			
	Soldering Temperature	T_{sol}	260 °C (For 10 seconds)			

1. AC For 1 Minute, R.H. = 40 ~ 60%

Isolation voltage shall be measured using the following method.

- (1) Short between anode and cathode on the primary side and between collector and emitter on the secondary side.
- (2) The isolation voltage tester with zero-cross circuit shall be used.
- (3) The waveform of applied voltage shall be a sine wave.

Photocoupler LTV-821X series

5.2 ELECTRICAL OPTICAL CHARACTERISTICS at Ta=25°C

Parameter		Symbol	Range	LTV-8212	LTV-8217	LTV-8214	LTV-8216	Test Condition
Input	LED Operating Current	I_{Fon}	Typ.	0.8mA				$I_L=Max.$
			Max.	3mA				
	LED Turn off Current	I_{Foff}	Min.	0.4mA				$I_L=Max.$
			Typ.	0.6mA				
Dropout Voltage	V_F	Typ.	1.3V				$I_F=50mA$	
		Max.	1.5V					
Output	On Resistance	R_{on}	Typ.	1.16 Ω	8.5 Ω	16.4 Ω	46 Ω	$I_F=5mA$
			Max.	2.5 Ω	15 Ω	35 Ω	120 Ω	$I_L=Max.$
	Off state leakage current	I_{leak}	Max.	1 μA				$I_F=0mA,$ $V_L=Max.$
Transfer characteristics	Turn on time	T_{on}	Typ.	0.65 ms	0.58 ms	0.61 ms	0.37 ms	$I_F=5mA$
			Max.	4 ms	2 ms			
	Turn off time	T_{off}	Typ.	0.22 ms	0.18 ms	0.18 ms	0.2 ms	$I_F=5mA$
			Max.	1 ms				$I_L=Max.$
Isolation Resistance	R_{iso}	Min.	$5 \times 10^{10} \Omega$				DC500V, 40 ~ 60% R.H.	

Note :

1. Turn on / turn off time

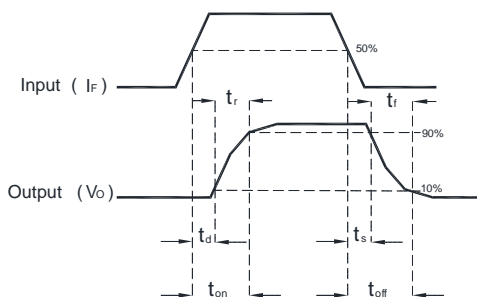

Photocoupler LTV-821X series

6. CHARACTERISTICS CURVES

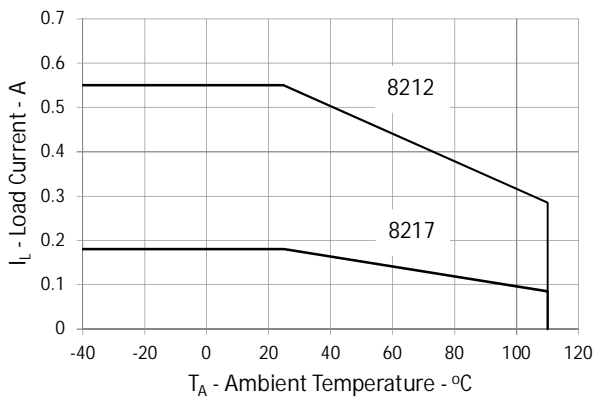

Fig. 1-(1) Load Current vs. Ambient Temperature

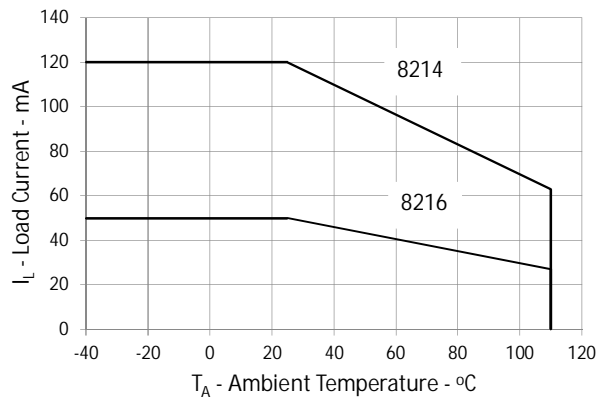

Fig. 1-(2) Load Current vs. Ambient Temperature

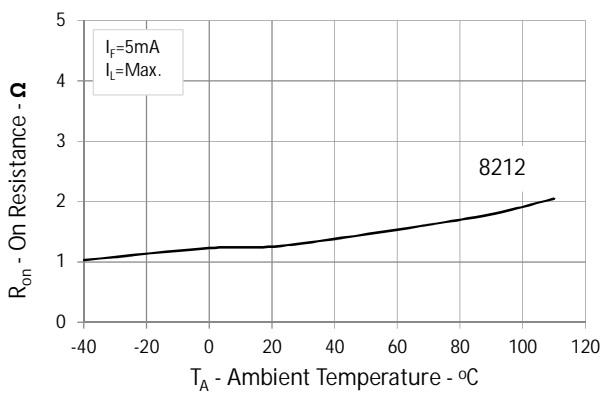

Fig. 2-(1) On Resistance vs. Ambient Temperature

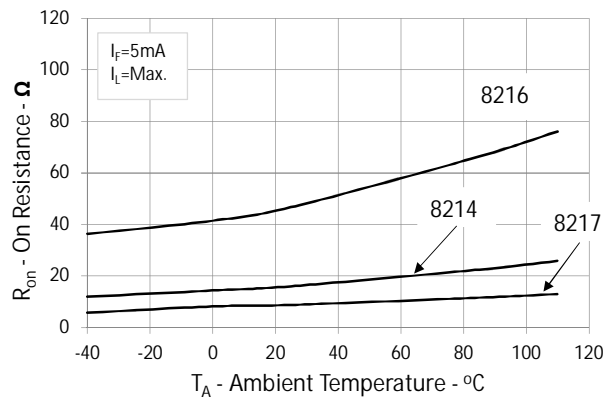

Fig. 2-(2) On Resistance vs. Ambient Temperature

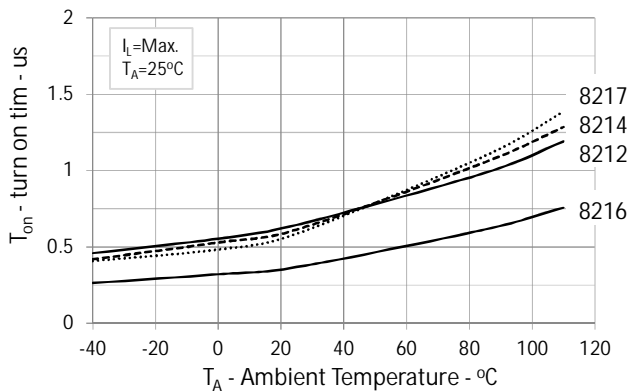

Fig. 3 Turn on time vs. Ambient Temperature

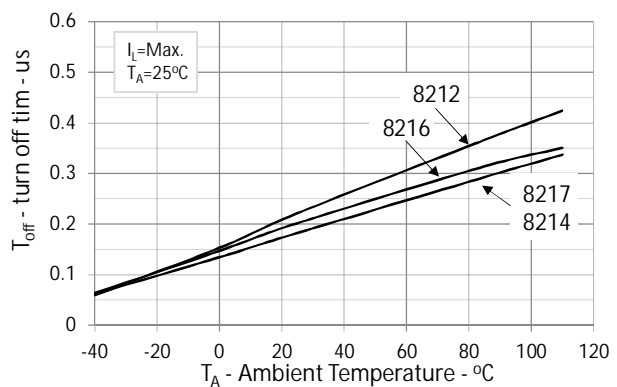

Fig. 4 Turn off time vs. Ambient Temperature

Photocoupler LTV-821X series

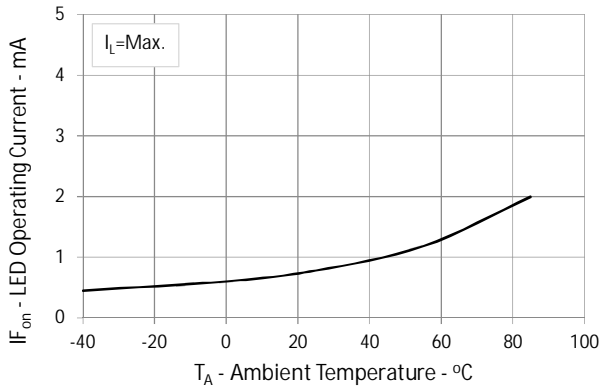

Fig. 5 LED Operating Current vs. Ambient Temperature

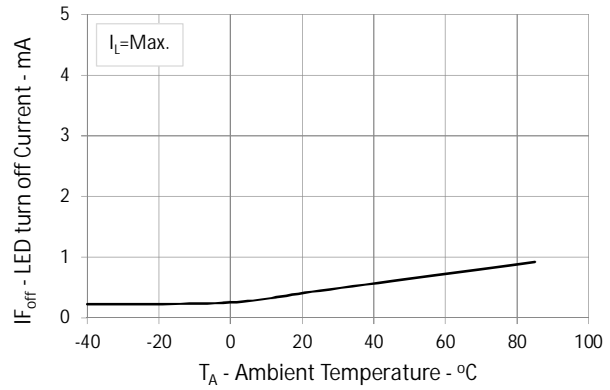

Fig. 6 Turn Off Time vs. Ambient Temperature

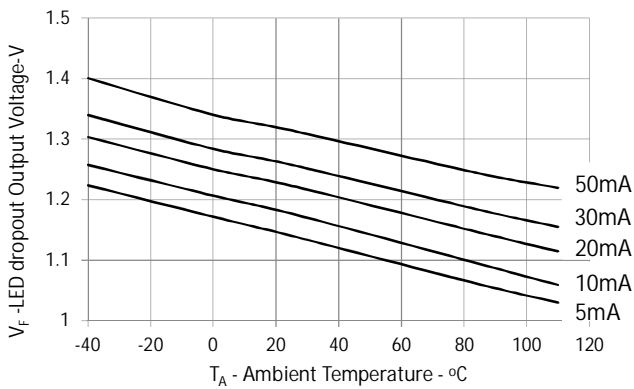

Fig. 7 LED dropout voltage vs. Ambient Temperature

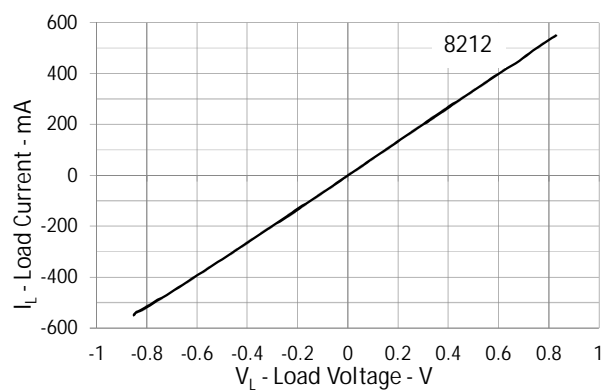

Fig. 8-(1). Load Current vs. Load Voltage

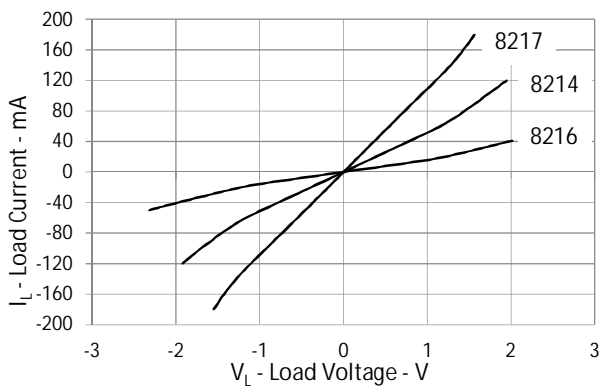

Fig. 8-(2). Load Current vs. Load Voltage

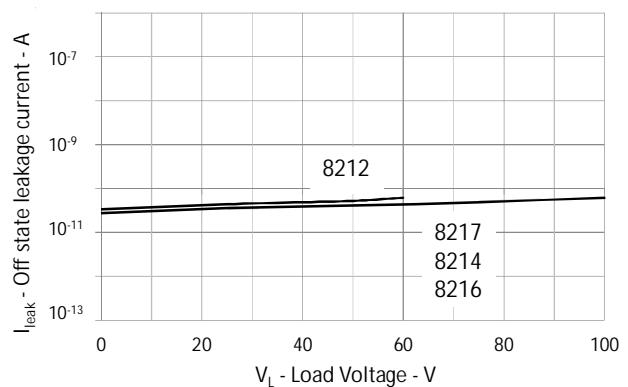

Fig. 9. Off State Leakage Current vs. Load Voltage

**Photocoupler
LTV-821X series**

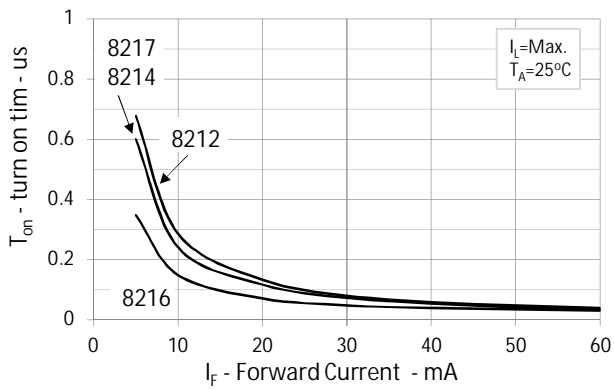

Fig. 10. Turn on time vs. LED Forward Current

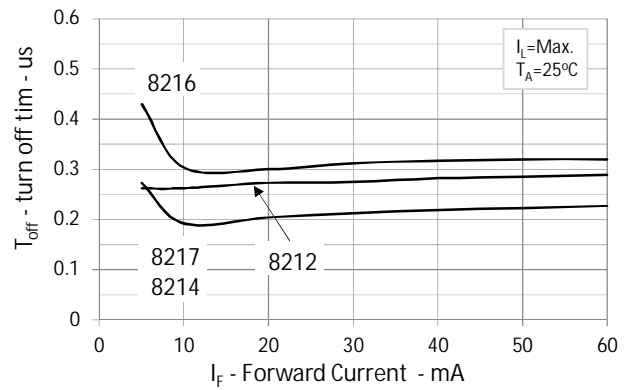

Fig. 11. Turn off time vs. LED Forward Current

Photocoupler LTV-821X series

7. TEMPERATURE PROFILE OF SOLDERING

7.1 IR Reflow soldering (JEDEC-STD-020C compliant)

One time soldering reflow is recommended within the condition of temperature and time profile shown below. Do not solder more than twice

Profile item	Conditions
Preheat	
- Temperature Min (T_{Smin})	150°C
- Temperature Max (T_{Smax})	200°C
- Time (min to max) (ts)	90±30 sec
Soldering zone	
- Temperature (T_L)	217°C
- Time (t_L)	60 sec
Peak Temperature (T_P)	260°C
Ramp-up rate	3°C / sec max.
Ramp-down rate	3~6°C / sec

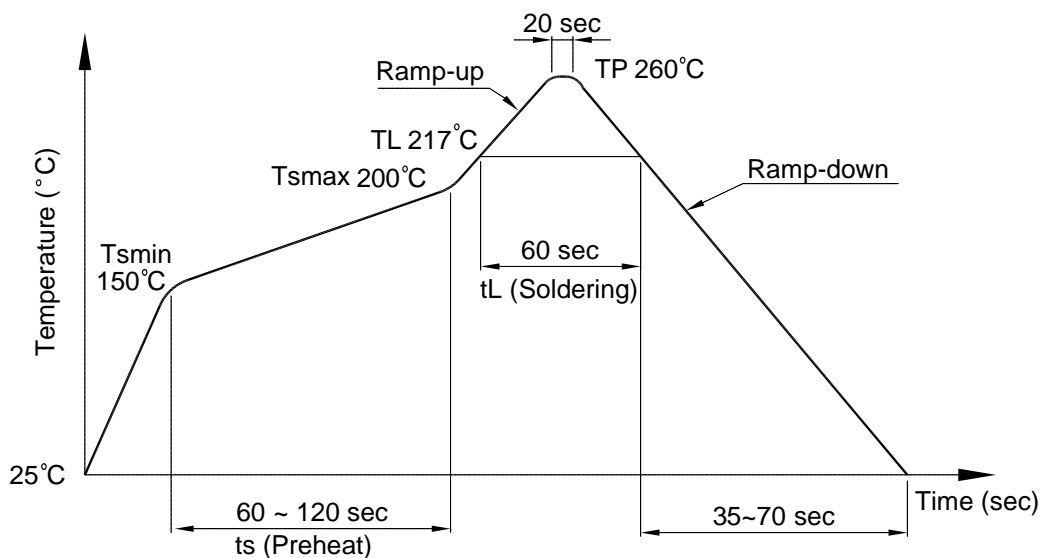

Photocoupler LTV-821X series

7.2 Wave soldering (JEDEC22A111 compliant)

One time soldering is recommended within the condition of temperature.

Temperature: $260 \pm 0 / -5^{\circ}\text{C}$

Time: 10 sec.

Preheat temperature: 25 to 140°C

Preheat time: 30 to 80 sec.

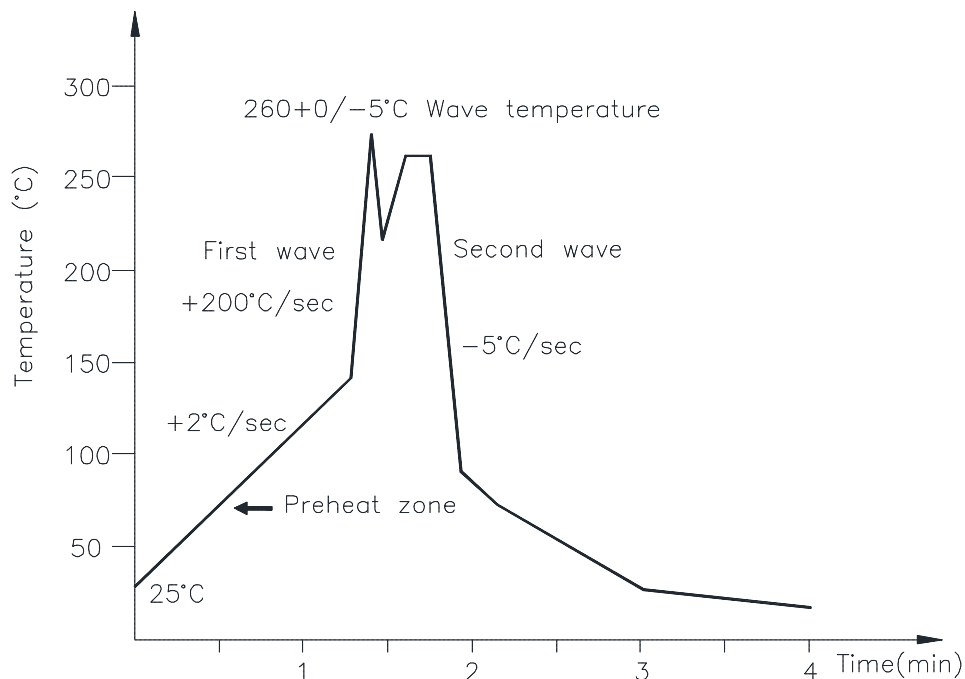

7.3 Hand soldering by soldering iron

Allow single lead soldering in every single process. One time soldering is recommended.

Temperature: $380 \pm 0 / -5^{\circ}\text{C}$

Time: 3 sec max.

8. NOTES

- LiteOn is continually improving the quality, reliability, function or design and LiteOn reserves the right to make changes without further notices.
- The products shown in this publication are designed for the general use in electronic applications such as office automation equipment, communications devices, audio/visual equipment, electrical application and instrumentation.
- For equipment/devices where high reliability or safety is required, such as space applications, nuclear power control equipment, medical equipment, etc, please contact our sales representatives.
- When requiring a device for any "specific" application, please contact our sales in advice.
- If there are any questions about the contents of this publication, please contact us at your convenience.
- The contents described herein are subject to change without prior notice.
- Immerge unit's body in solder paste is not recommended.

单击下面可查看定价，库存，交付和生命周期等信息

[>>Lite-On\(光宝\)](#)