



Photocoupler
Product Data Sheet
LTV-3063

Spec No. :DS70-2014-0024
Effective Date: 04/13/2021
Revision: B

LITE-ON DCC

RELEASE

BNS-OD-FC001/A4

Photocoupler LTV-306X series

1. DESCRIPTION

1.1 Features

- Isolation voltage between input and output V_{iso} : 3,750Vrms
- 4pin MFP zero-cross optoisolators triac driver output
- High repetitive peak off-state voltage V_{DRM} : Min. 600V
- High critical rate of rise of off-state voltage (dV/dt : MIN. 1000V / μs)
- Mini-flat package :
2.0mm profile : LTV-3061, LTV-3062, LTV-3063
- Safety approval
UL 1577
cUL CA5A
VDE DIN EN60747-5-5 (VDE 0884-5)
- RoHS Compliance
All materials be used in device are followed EU RoHS directive (No.2002/95/EC).
- ESD pass HBM 8000V / MM2000V
- MSL class1
- Halogen free option

1.2 Applications

- Motor Controls
- Solid state relays
- For triggering high power thyristor and triac
- Household use equipment

Photocoupler LTV-306X series

2. PACKAGE DIMENSIONS

2.1 LTV-306X series

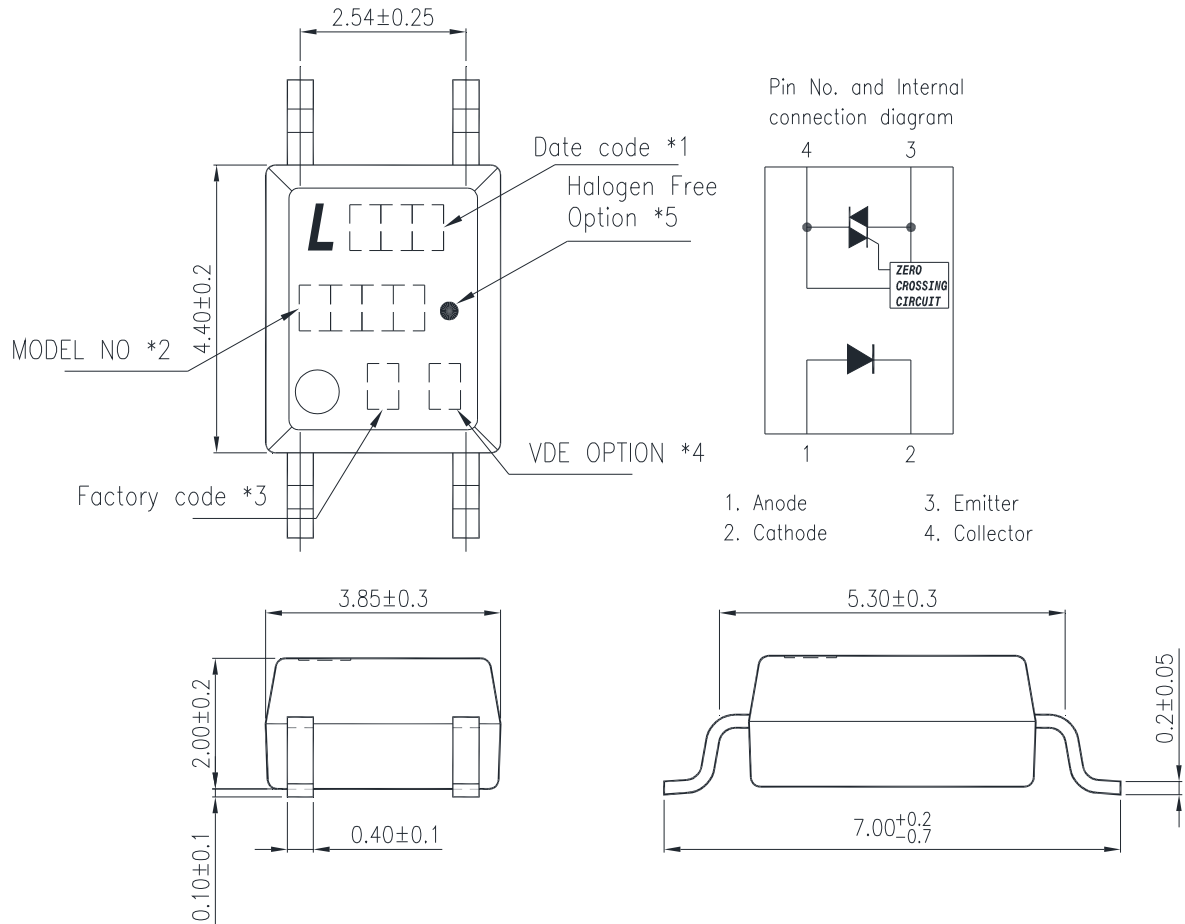

Notes :

1. 1-digit year code, Example : 2010 = A
2-digit work week ranging from '01' to '53'
2. Model No. : 3061 / 3062 / 3063
3. Factory identification mark (X: China-TJ)
4. "4" or "V" for VDE option.
5. "●" for halogen free option.

*All dimensions in millimeters.

Photocoupler LTV-306X series

3. TAPING DIMENSIONS

3.1 LTV-306X-TP

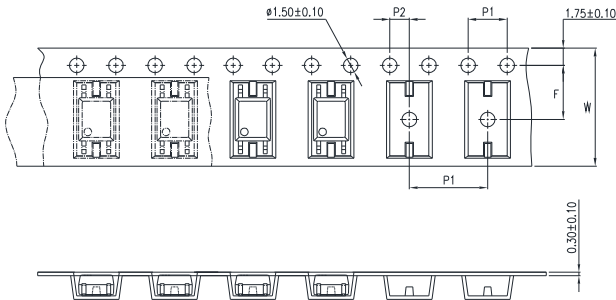

3.2 LTV-306X

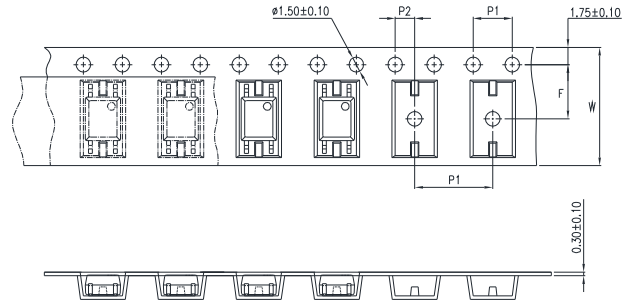

Description	Symbol	Dimension in mm (inch)
Tape wide	W	12±0.3 (0.472)
Pitch of sprocket holes	P ₀	4±0.1 (0.157)
Distance of compartment	F	5.5±0.1 (0.217)
	P ₂	2±0.1 (0.079)
Distance of compartment to compartment	P ₁	8±0.1 (0.315)

3.3 Quantities Per Reel

Package Type	LTV-306X series
Quantities (pcs)	3000

Photocoupler LTV-306X series

4. RATING AND CHARACTERISTICS

4.1 Absolute Maximum Ratings at Ta=25°C

	Parameter	Symbol	Rating	Unit
Input	Forward Current	I_F	50	mA
	Reverse Voltage	V_R	6	V
	Power Dissipation	P_D	70	mW
	Junction Temperature	T_J	125	°C
Output	Off-State Output Terminal Voltage	V_{DRM}	600	V
	Peak Repetitive Surge Current (PW=1ms, 120pps)	V_{TSM}	1	A
	Collector Power Dissipation	P_C	300	mW
	Junction Temperature	T_J	125	°C
	Total Power Dissipation	P_{tot}	330	mW
*1.	Isolation Voltage	V_{iso}	3750	V_{rms}
	Ambient Operating Temperature Range	T_A	-55 ~ +115	°C
	Storage Temperature	T_{stg}	-55 ~ +150	°C
*2.	Soldering Temperature	T_L	260	°C

*1. AC For 1 Minute, R.H. = 40 ~ 60%

Isolation voltage shall be measured using the following method.

- (1) Short between anode and cathode on the primary side and between collector and emitter on the secondary side.
- (2) The isolation voltage tester with zero-cross circuit shall be used.
- (3) The waveform of applied voltage shall be a sine wave.

*2. For 10 Seconds

Photocoupler LTV-306X series

4.2 Recommended Operating Conditions (Note)

Characteristics	Symbol	Min.	Typ.	Max.	Unit
Supply Voltage	V_{AC}	-	-	240	Vac
Forward Current	LTV-3061	22.5	25	30	mA
	LTV-3062	15	20	30	mA
	LTV-3063	7.5	10	30	mA
Operating Temperature	T_{opr}	-25	-	85	°C

Note: Recommended operating conditions are given as a design guideline to obtain expected performance of the device. Additionally, each item is an independent guideline respectively. In developing designs using this product, please confirm specified characteristics shown in this document.

Photocoupler LTV-306X series

4.2 ELECTRICAL OPTICAL CHARACTERISTICS at Ta=25°C

Parameter		Symbol	Min.	Typ.	Max.	Unit	Test Condition
Input	Forward Voltage	V_F	—	1.2	1.4	V	$I_F=20\text{mA}$
	Reverse Current	I_R	—	0.05	10	μA	$V_R=6\text{V}$
Output	*1 Peak Blocking Current, Either Direction	I_{DRM}	—	—	500	nA	$V_{DRM}=600\text{V}$
	Peak On-State Voltage, Either Direction	V_{TM}	—	—	3.0	V	$I_{TM}=100\text{ mA Peak}$
	*2 Critical Rate of Rise of Off-State Voltage	dv/dt	1000	—	—	V/ μs	
COUPLED	Led Trigger Current, Current Required to Latch Output, Either Direction	LTV-3061	—	—	15	mA	Main Terminal Voltage = 3V
		LTV-3062	—	—	10		
		LTV-3063	—	—	5		
	Holding Current, Either Direction	I_H	—	200	—	μA	
ZERO CROSSING	Inhibit Voltage	V_{INH}	—	5	20	Volts	$I_F=\text{Rated } I_{FT}$, MT1-MT2 Voltage above which device will not trigger
	Leakage in Inhibited State	I_{DRM2}	—	—	500	μA	$I_F = \text{Rated } I_{FT}$, Rated V_{DRM} , Off State

*1 Test voltage must be applied within dv/dt rating.

*2 This is static dv/dt. Commutating dv/dt is a function of the load-driving thyristor(s) only.

Photocoupler
LTV-306X series

5. CHARACTERISTICS CURVES (TYPICAL PERFORMANCE)

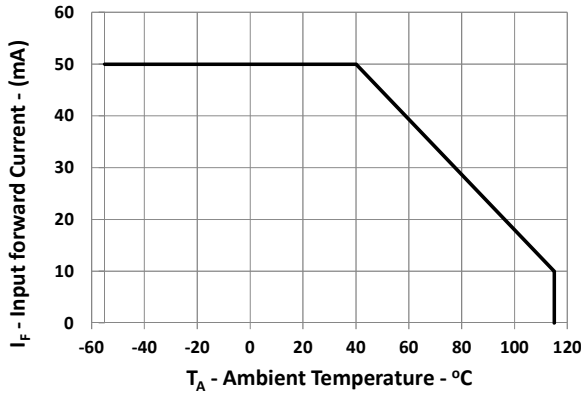

Fig.1 Forward current vs. T_A

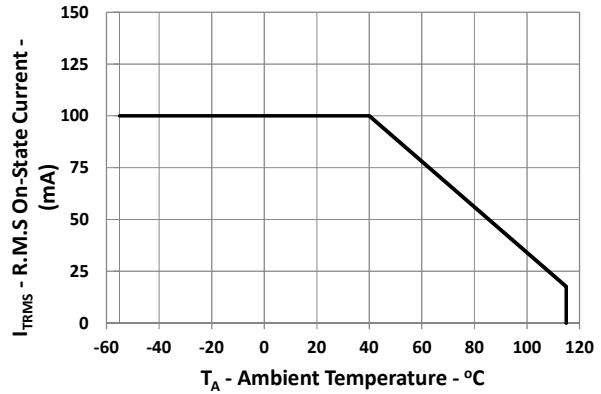

Fig 2 On-state current vs. T_A

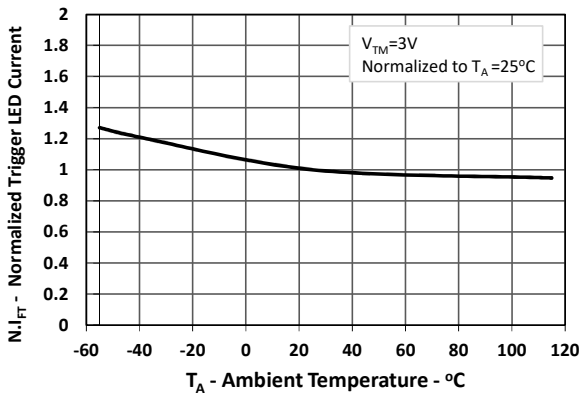

Fig 3. Normalized I_{FT} vs. T_A

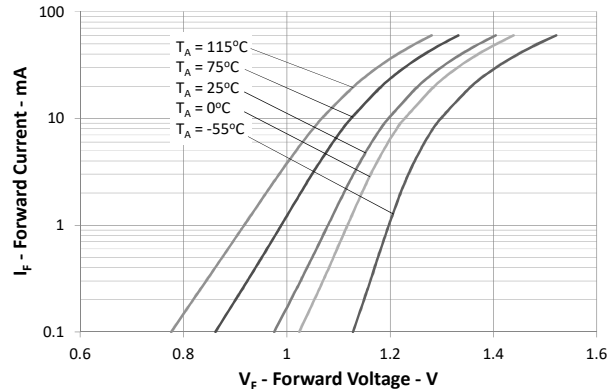

Fig 4. I_F vs. V_F

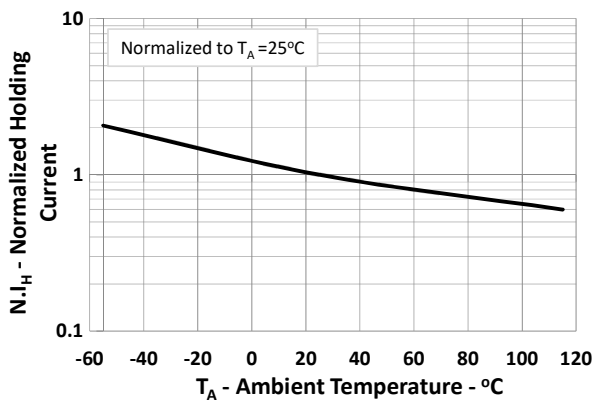

Fig 5. Normalized I_H vs. T_A

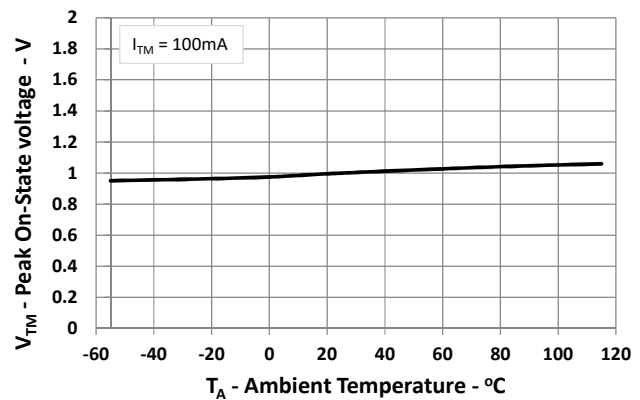

Fig 6. Normalized V_{TM} vs. T_A

Photocoupler LTV-306X series

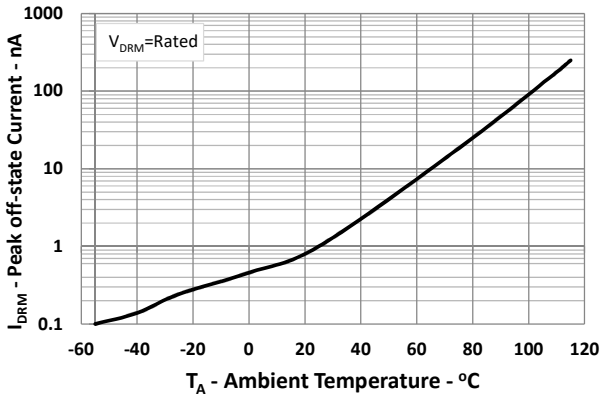

Fig.7 Normalized I_{DRM} vs. T_A

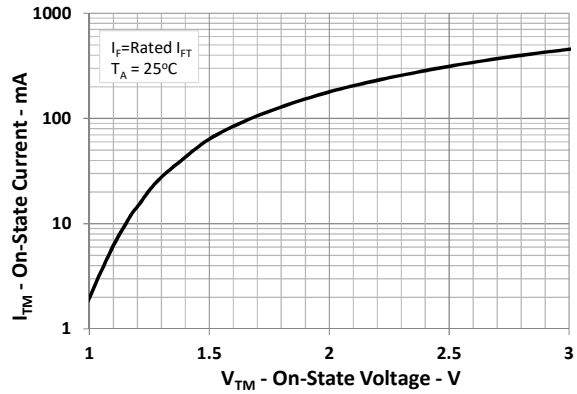

Fig.8 Normalized I_{TM} vs. V_{TM}

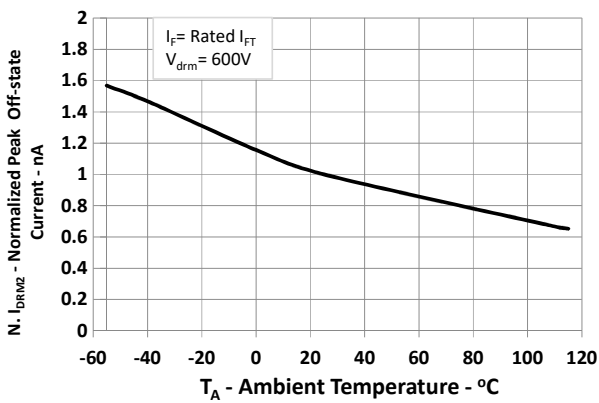

Fig.9 Normalized I_{DRM2} vs. T_A

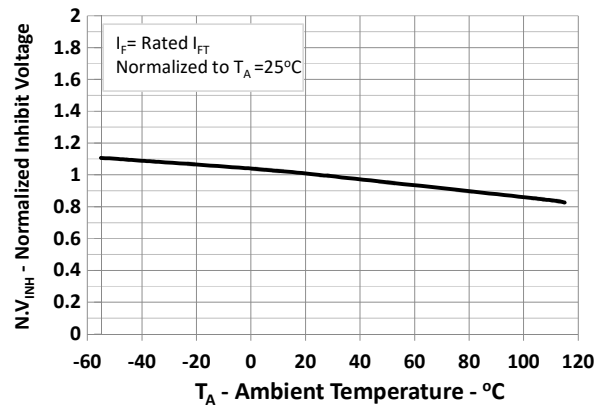

Fig.10 Normalized V_{INH} vs. T_A

Photocoupler LTV-306X series

6. TEMPERATURE PROFILE OF SOLDERING

6.1 IR Reflow soldering (JEDEC-STD-020E compliant)

One time soldering reflow is recommended within the condition of temperature and time profile shown below. Do not solder more than three times.

Profile item	Conditions
Preheat	
- Temperature Min (T_{Smin})	150°C
- Temperature Max (T_{Smax})	200°C
- Time (min to max) (ts)	90±30 sec
Soldering zone	
- Temperature (T_L)	217°C
- Time (t_L)	60 sec
Peak Temperature (T_P)	260°C
Ramp-up rate	3°C / sec max.
Ramp-down rate	3~6°C / sec

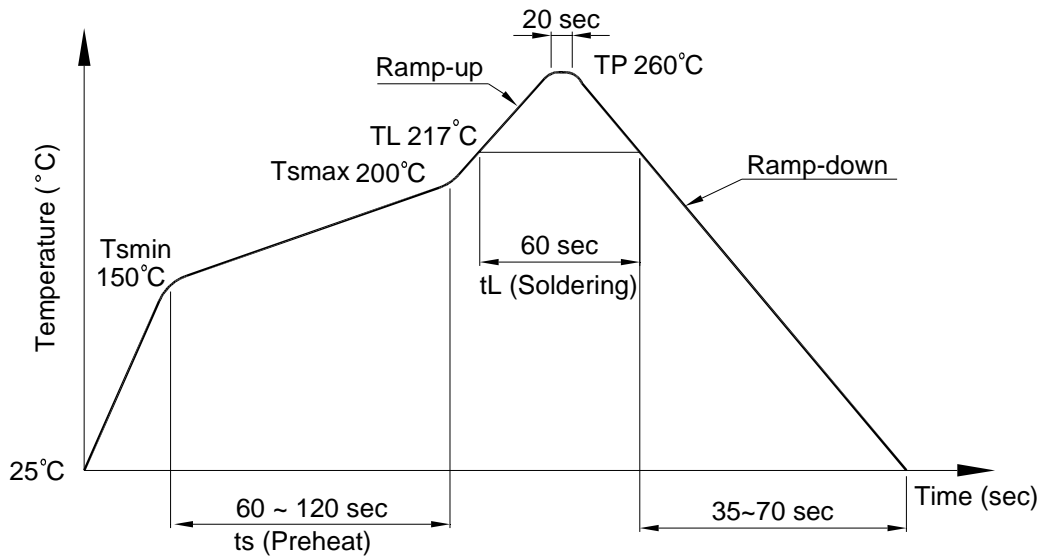

**Photocoupler
LTV-306X series**

6.2 Wave soldering (JEDEC22A111 compliant)

One time soldering is recommended within the condition of temperature.

Temperature: $260 \pm 0 / -5^{\circ}\text{C}$

Time: 10 sec.

Preheat temperature: 25 to 140°C

Preheat time: 30 to 80 sec.

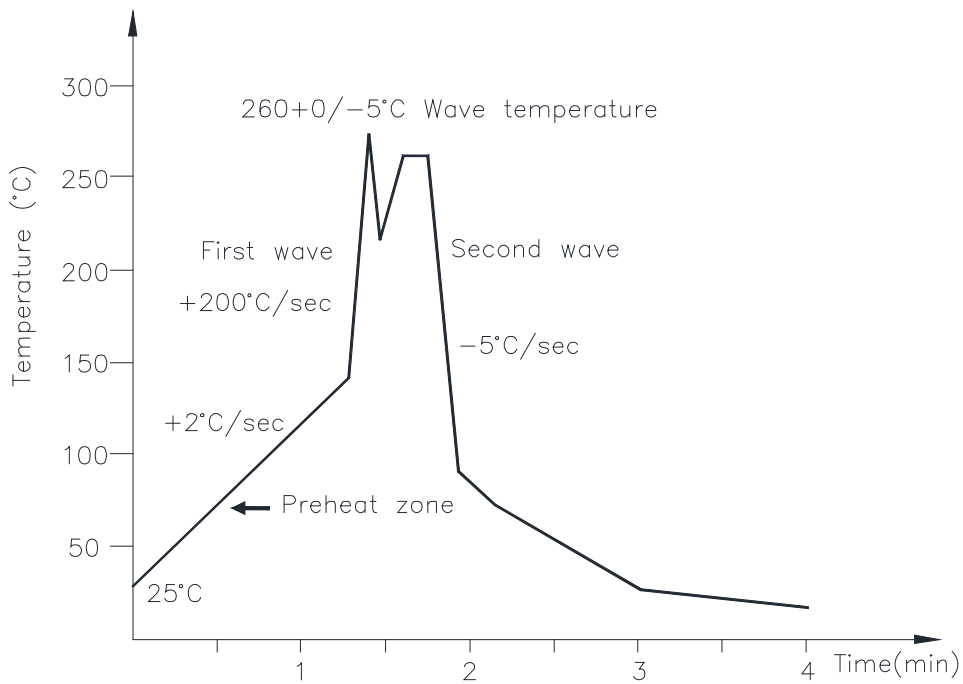

6.3 Hand soldering by soldering iron

Allow single lead soldering in every single process. One time soldering is recommended.

Temperature: $380 \pm 0 / -5^{\circ}\text{C}$

Time: 3 sec max.

Photocoupler
LTV-306X series

7. RRECOMMENDED FOOT PRINT PATTERNS (MOUNT PAD)

Unit: mm

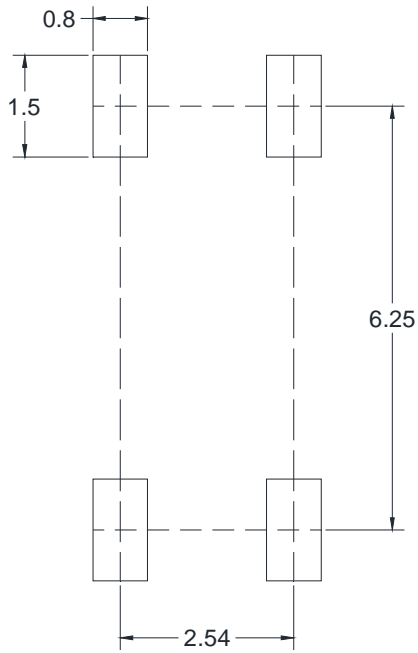

**Photocoupler
LTV-306X series**

8. NAMING RULE

LTV-306(X)(1)-G

DEVICE PART NUMBER

Please refer to Electrical Optical
Characteristics Table on Page 5

(1) TAPING TYPE (TP, TP1)

(2) Halogen free

Example : LTV-3061-TP1-G

LTV306(X)(1)-V-G

DEVICE PART NUMBER

Please refer to Electrical Optical
Characteristics Table on Page 5

(1) TAPING TYPE (TP, TP1)

(2) VDE option

(3) Halogen free

Example : LTV3061TP1-V-G

9. NOTES

- LiteOn is continually improving the quality, reliability, function or design and LiteOn reserves the right to make changes without further notices.
- The products shown in this publication are designed for the general use in electronic applications such as office automation equipment, communications devices, audio/visual equipment, electrical application and instrumentation.
- For equipment/devices where high reliability or safety is required, such as space applications, nuclear power control equipment, medical equipment, etc, please contact our sales representatives.
- When requiring a device for any "specific" application, please contact our sales in advice.
- If there are any questions about the contents of this publication, please contact us at your convenience.
- The contents described herein are subject to change without prior notice.
- Immerge unit's body in solder paste is not recommended.

单击下面可查看定价，库存，交付和生命周期等信息

[>>Lite-On\(光宝\)](#)