

RoHS Sx01E & SxN1 Series

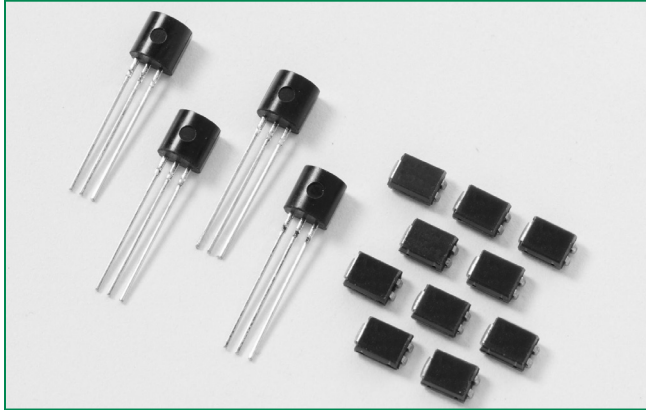

Description

Excellent for lower current heat, lamp, and audible alarm controls for home goods.

Standard phase control SCRs are triggered with few milliamperes of current at less than 1.5V potential.

Features & Benefits

- RoHS compliant
- Glass – passivated junctions
- Voltage capability up to 600 V
- Surge capability up to 30 A

Applications

Typical applications are AC solid-state switches, fluidlevel sensors, strobes, and capacitive-discharge ignition systems.

Main Features

| Symbol | Value | Unit |
|-------------------|------------|------|
| $I_{T(RMS)}$ | 1 | A |
| V_{DRM}/V_{RRM} | 400 to 600 | V |
| I_{GT} | 10 | mA |

Schematic Symbol

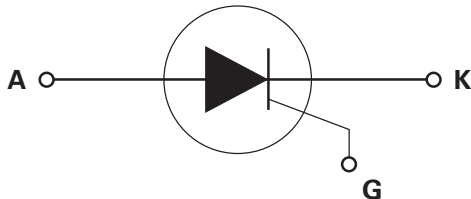

Absolute Maximum Ratings – Standard SCRs

| Symbol | Parameter | Test Conditions | Value | Unit |
|--------------|---|--|------------|------------------------|
| $I_{T(RMS)}$ | RMS on-state current | $T_c = 90^\circ\text{C}$ | 1 | A |
| $I_{T(AV)}$ | Average on-state current | $T_c = 90^\circ\text{C}$ | 0.64 | A |
| I_{TSM} | Peak non-repetitive surge current | single half cycle; $f = 50\text{Hz}$; T_j (initial) = 25°C | 25 | A |
| | | single half cycle; $f = 60\text{Hz}$; T_j (initial) = 25°C | 30 | |
| I_2t | I_2t Value for fusing | $t_p = 8.3 \text{ ms}$ | 3.7 | A^2s |
| di/dt | Critical rate of rise of on-state current | $f = 60\text{Hz}$; $T_j = 125^\circ\text{C}$ | 50 | $\text{A}/\mu\text{s}$ |
| I_{GM} | Peak gate current | $T_j = 125^\circ\text{C}$ | 1.5 | A |
| $P_{G(AV)}$ | Average gate power dissipation | $T_j = 125^\circ\text{C}$ | 0.3 | W |
| T_{stg} | Storage temperature range | | -40 to 150 | $^\circ\text{C}$ |
| T_j | Operating junction temperature range | | -40 to 125 | $^\circ\text{C}$ |

1.0A SCRs

Electrical Characteristics ($T_J = 25^\circ\text{C}$, unless otherwise specified)

| Symbol | Test Conditions | | Value | Unit |
|----------|---|------|-------|------------------|
| I_{GT} | $V_D = 12\text{V}; R_L = 60\ \Omega$ | MAX. | 10 | mA |
| | | MIN. | 1 | |
| V_{GT} | | MAX. | 1.5 | V |
| dv/dt | $V_D = V_{DRM};$ gate open; $T_J = 100^\circ\text{C}$ | MIN. | 20 | V/ μs |
| | $V_D = V_{DRM};$ gate open; $T_J = 125^\circ\text{C}$ | | 40 | |
| V_{GD} | $V_D = V_{DRM}; R_L = 3.3\ \text{k}\Omega; T_J = 125^\circ\text{C}$ | MIN. | 0.2 | V |
| I_H | $I_T = 200\text{mA}$ (initial) | MAX. | 30 | mA |
| t_q | (1) | MAX. | 35 | μs |
| t_{gt} | $I_G = 2 \times I_{GT}; \text{PW} = 15\mu\text{s}; I_T = 2\text{A}$ | TYP. | 2 | μs |

(1) $I_T = 1\text{A}; t_p = 50\mu\text{s}; dv/dt = 20\text{V}/\mu\text{s}; di/dt = -10\text{A}/\mu\text{s}$

Static Characteristics

| Symbol | Test Conditions | | Value | Unit | |
|---------------------|---|---------------------------|-------|------|---------------|
| V_{TM} | $I_T = 2\text{A}; t_p = 380\ \mu\text{s}$ | MAX. | 1.6 | V | |
| I_{DRM} / I_{RRM} | $V_{DRM} = V_{RRM}$ | $T_J = 25^\circ\text{C}$ | MAX. | 10 | μA |
| | | $T_J = 100^\circ\text{C}$ | | 200 | |
| | | $T_J = 125^\circ\text{C}$ | | 500 | |

Thermal Resistances

| Symbol | Parameter | | Value | Unit |
|-------------------|-----------------------|-------|-------|---------------------------|
| $R_{\theta(J-C)}$ | Junction to case (AC) | Sx01E | 50 | $^\circ\text{C}/\text{W}$ |
| | | SxN1 | 35* | |
| $R_{\theta(J-A)}$ | Junction to ambient | Sx01E | 145 | $^\circ\text{C}/\text{W}$ |

Notes : x = voltage

* = Mounted on 1 cm² copper (two-ounce) foil surface

Figure 1: Normalized DC Gate Trigger Current vs. Junction Temperature

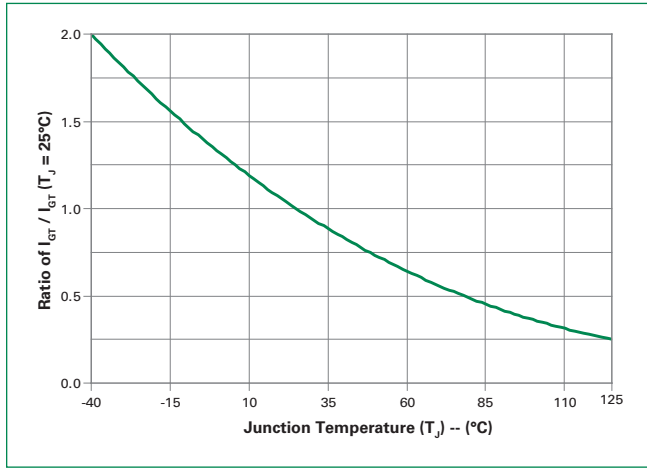

Figure 2: Normalized DC Gate Trigger Voltage vs. Junction Temperature

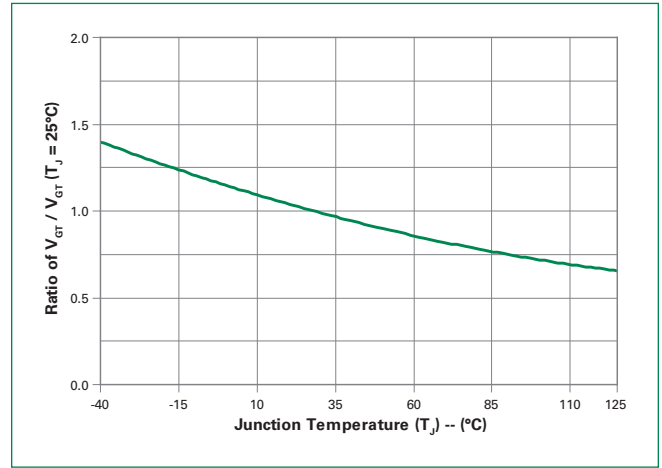

Figure 3: Normalized DC Holding Current vs. Junction Temperature

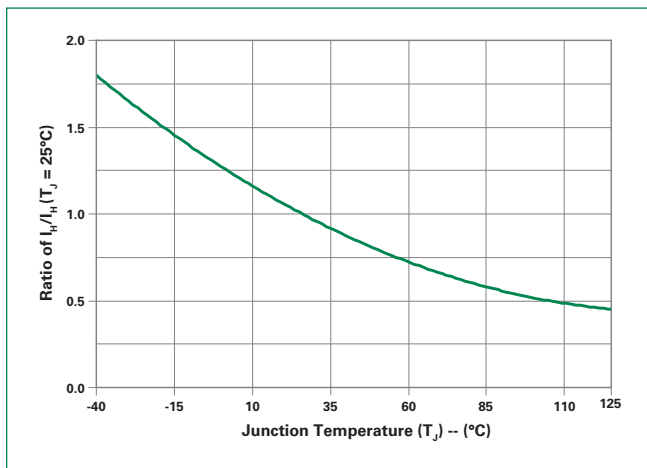

Figure 4: On-State Current vs. On-State Voltage (Typical)

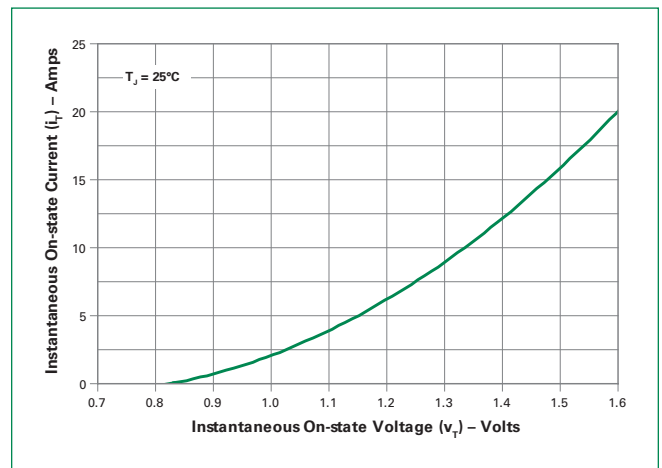

Figure 5: Power Dissipation (Typical) vs. RMS On-State Current

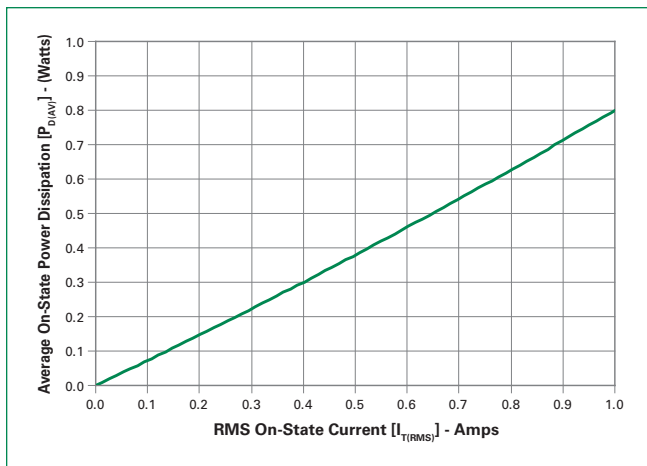

Figure 6: Maximum Allowable Case Temperature vs. RMS On-State Current

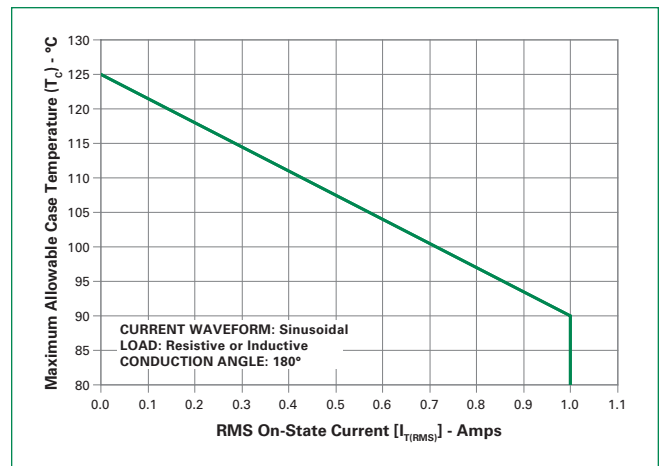

Figure 7: Maximum Allowable Case Temperature vs. Average On-State Current

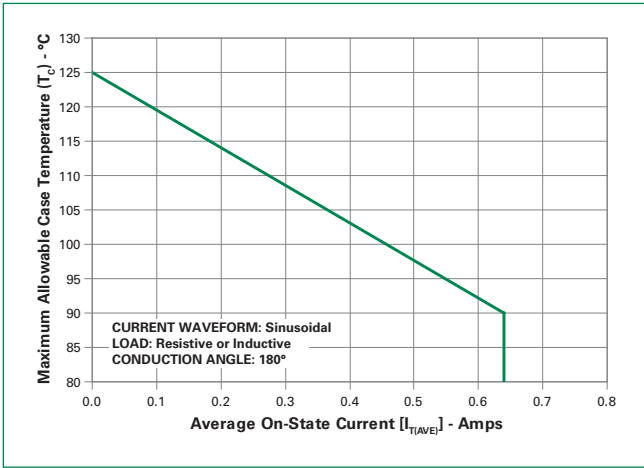

Figure 8: Maximum Allowable Ambient Temperature vs. RMS On-State Current

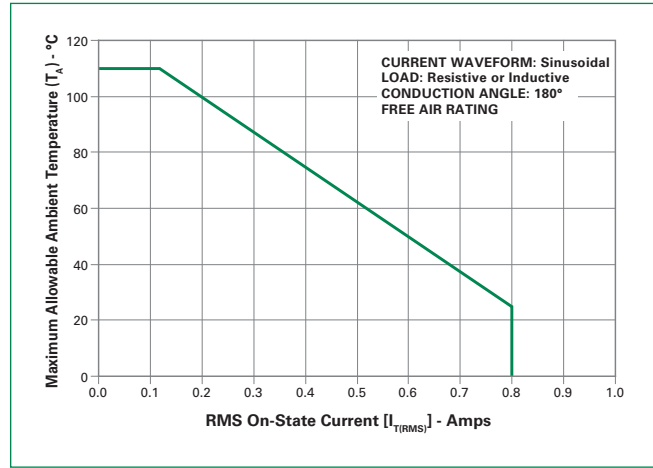

Figure 9: Maximum Allowable Ambient Temperature vs. Average On-State Current

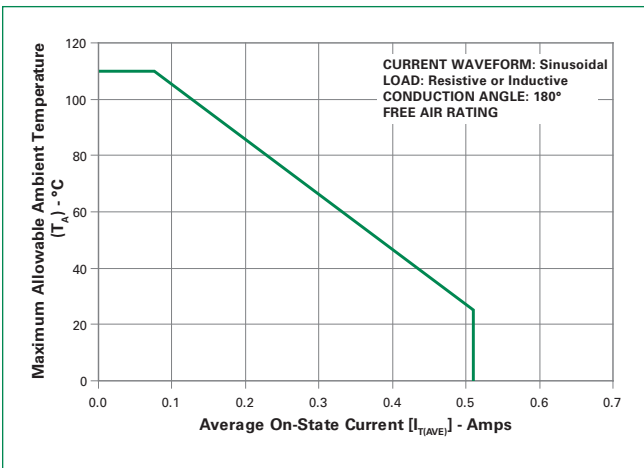

Figure 10: Peak Capacitor Discharge Current

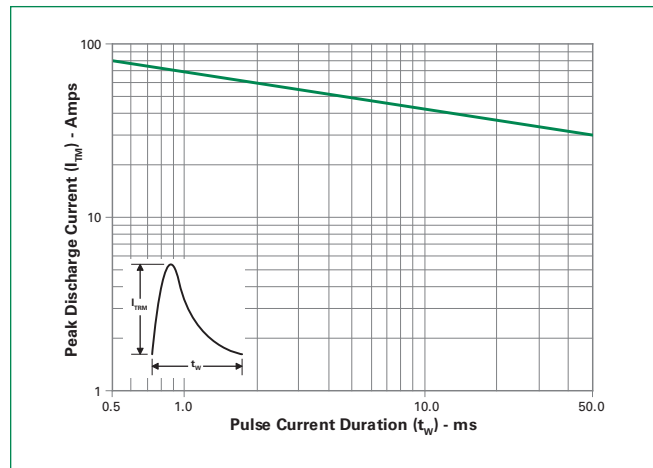

Figure 11: Peak Capacitor Discharge Current Derating

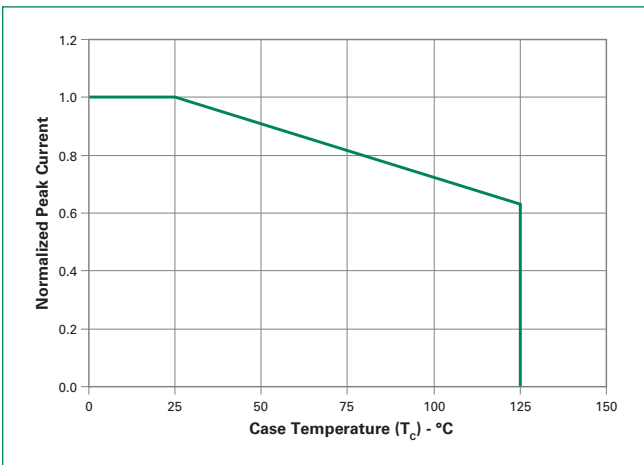
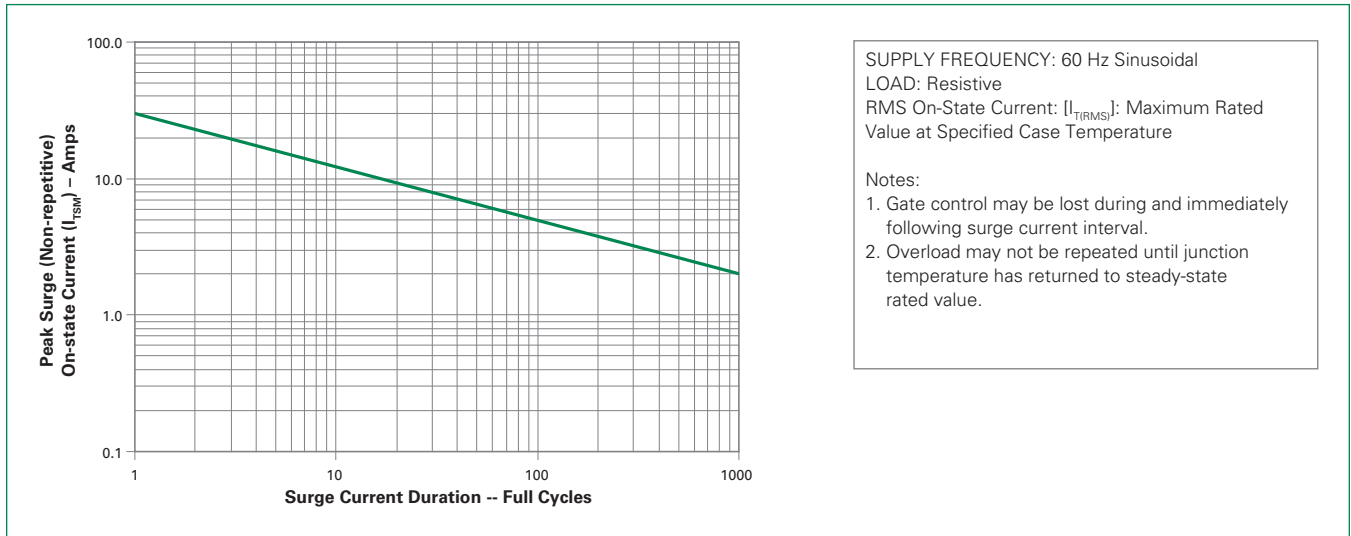
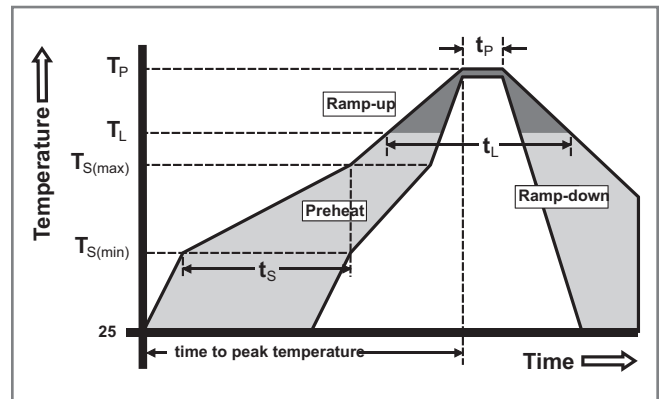

Figure 12: Surge Peak On-State Current vs. Number of Cycles



Soldering Parameters

| | | |
|--|------------------------------------|-------------------------|
| Reflow Condition | | Pb – Free assembly |
| Pre Heat | - Temperature Min ($T_{s(min)}$) | 150°C |
| | - Temperature Max ($T_{s(max)}$) | 200°C |
| | - Time (min to max) (t_s) | 60 – 180 secs |
| Average ramp up rate (Liquidus Temp) (T_L) to peak | | 5°C/second max |
| $T_{s(max)}$ to T_L - Ramp-up Rate | | 5°C/second max |
| Reflow | - Temperature (T_L) (Liquidus) | 217°C |
| | - Temperature (t_L) | 60 – 150 seconds |
| Peak Temperature (T_p) | | 260 ^{+0/-5} °C |
| Time within 5°C of actual peak Temperature (t_p) | | 20 – 40 seconds |
| Ramp-down Rate | | 5°C/second max |
| Time 25°C to peak Temperature (T_p) | | 8 minutes Max. |
| Do not exceed | | 280°C |



1.0A SCRs

Physical Specifications

| | |
|------------------------|---|
| Terminal Finish | 100% Matte Tin-plated |
| Body Material | UL recognized epoxy meeting flammability classification 94V-0 |
| Lead Material | Copper Alloy |

Design Considerations

Careful selection of the correct device for the application's operating parameters and environment will go a long way toward extending the operating life of the Thyristor. Good design practice should limit the maximum continuous current through the main terminals to 75% of the device rating. Other ways to ensure long life for a power discrete semiconductor are proper heat sinking and selection of voltage ratings for worst case conditions. Overheating, overvoltage (including dv/dt), and surge currents are the main killers of semiconductors. Correct mounting, soldering, and forming of the leads also help protect against component damage.

Environmental Specifications

| Test | Specifications and Conditions |
|----------------------------------|---|
| AC Blocking | MIL-STD-750, M-1040, Cond A Applied Peak AC voltage @ 125°C for 1008 hours |
| Temperature Cycling | MIL-STD-750, M-1051, 100 cycles; -40°C to +150°C; 15-min dwell-time |
| Temperature/Humidity | EIA / JEDEC, JESD22-A101 1008 hours; 320V - DC: 85°C; 85% rel humidity |
| High Temp Storage | MIL-STD-750, M-1031, 1008 hours; 150°C |
| Low-Temp Storage | 1008 hours; -40°C |
| Thermal Shock | MIL-STD-750, M-1056 10 cycles; 0°C to 100°C; 5-min dwell-time at each temperature; 10 sec (max) transfer time between temperature |
| Autoclave | EIA / JEDEC, JESD22-A102 168 hours (121°C at 2 ATMs) and 100% R/H |
| Resistance to Solder Heat | MIL-STD-750 Method 2031 |
| Solderability | ANSI/J-STD-002, category 3, Test A |
| Lead Bend | MIL-STD-750, M-2036 Cond E |

Dimensions – TO-92 (E Package)

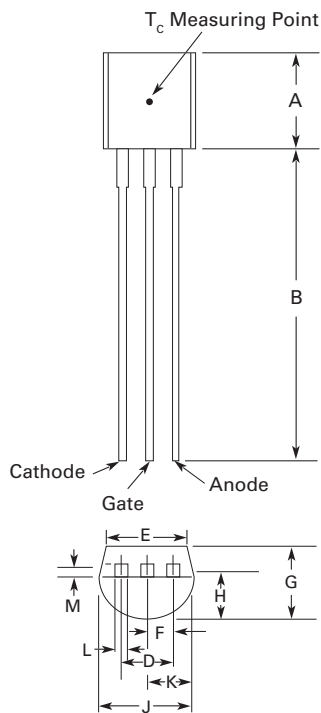

| Dimension | Inches | | Millimeters | |
|-----------|--------|-------|-------------|------|
| | Min | Max | Min | Max |
| A | 0.176 | 0.196 | 4.47 | 4.98 |
| B | 0.500 | | 12.70 | |
| D | 0.095 | 0.105 | 2.41 | 2.67 |
| E | 0.150 | | 3.81 | |
| F | 0.046 | 0.054 | 1.16 | 1.37 |
| G | 0.135 | 0.145 | 3.43 | 3.68 |
| H | 0.088 | 0.096 | 2.23 | 2.44 |
| J | 0.176 | 0.186 | 4.47 | 4.73 |
| K | 0.088 | 0.096 | 2.23 | 2.44 |
| L | 0.013 | 0.019 | 0.33 | 0.48 |
| M | 0.013 | 0.017 | 0.33 | 0.43 |

All leads insulated from case. Case is electrically nonconductive.

Dimensions - Compak (C Package)

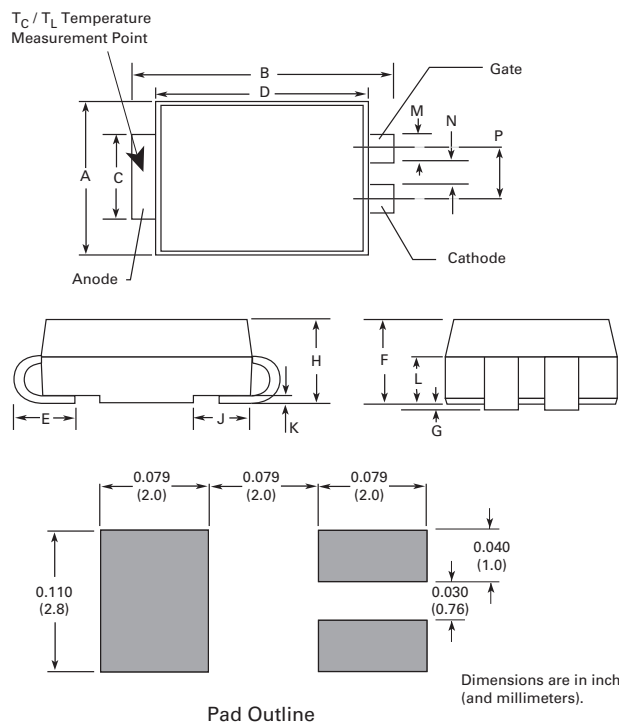

| Dimension | Inches | | Millimeters | |
|-----------|--------|-------|-------------|------|
| | Min | Max | Min | Max |
| A | 0.130 | 0.156 | 3.30 | 3.95 |
| B | 0.201 | 0.220 | 5.10 | 5.60 |
| C | 0.077 | 0.087 | 1.95 | 2.20 |
| D | 0.159 | 0.181 | 4.05 | 4.60 |
| E | 0.030 | 0.063 | 0.75 | 1.60 |
| F | 0.075 | 0.096 | 1.90 | 2.45 |
| G | 0.002 | 0.008 | 0.05 | 0.20 |
| H | 0.077 | 0.104 | 1.95 | 2.65 |
| J | 0.043 | 0.053 | 1.09 | 1.35 |
| K | 0.006 | 0.016 | 0.15 | 0.41 |
| L | 0.030 | 0.055 | 0.76 | 1.40 |
| M | 0.022 | 0.028 | 0.56 | 0.71 |
| N | 0.027 | 0.033 | 0.69 | 0.84 |
| P | 0.052 | 0.058 | 1.32 | 1.47 |

Product Selector

| Part Number | Voltage | | | | Gate Sensitivity | Type | Package |
|-------------|---------|------|------|-------|------------------|--------------|---------|
| | 400V | 600V | 800V | 1000V | | | |
| Sx01E | X | X | | | 10mA | Standard SCR | TO-92 |
| SxN1 | X | X | | | 10mA | Standard SCR | Compak |

Note: x = Voltage

Packing Options

| Part Number | Marking | Weight | Packing Mode | Base Quantity |
|-------------|---------|--------|------------------|---------------|
| Sx01E | Sx01E | 0.19 g | Bulk | 2000 |
| Sx01ERP | Sx01E | 0.19 g | Reel Pack | 2000 |
| Sx01EAP | Sx01E | 0.19 g | Ammo Pack | 2000 |
| SxN1RP | SxN1 | 0.08 g | Embossed Carrier | 2500 |

Note: x = Voltage

1.0A SCRs

TO-92 (3-lead) Reel Pack (RP) Radial Leaded Specifications

Meets all EIA-468-B 1994 Standards

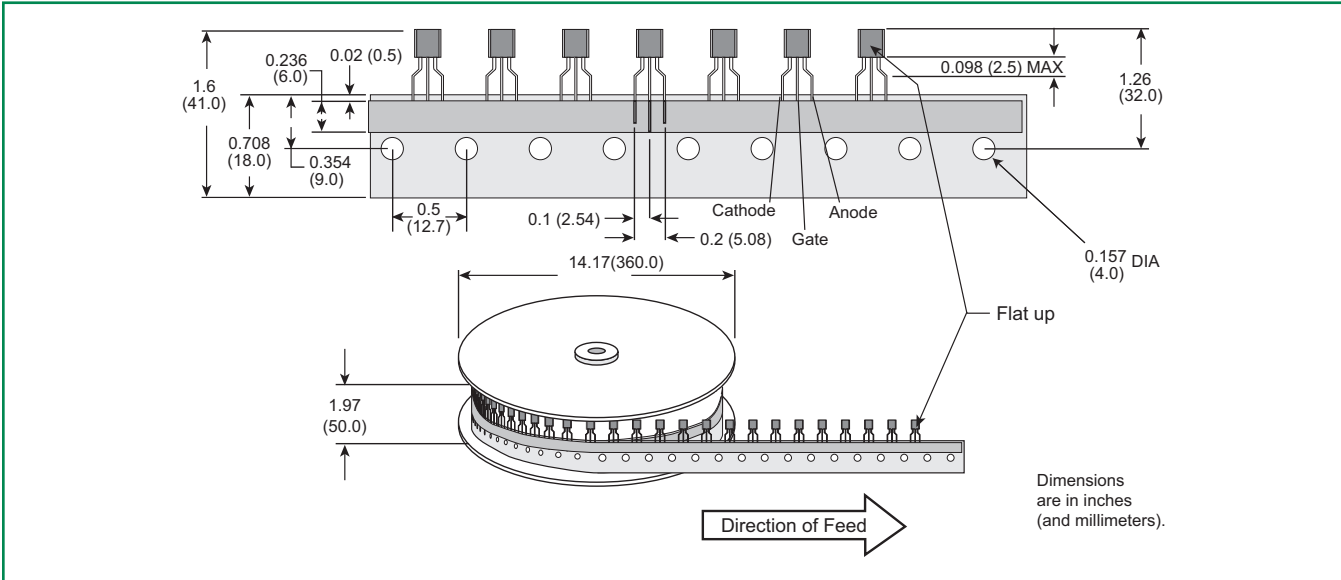

TO-92 (3-lead) Ammo Pack (AP) Radial Leaded Specifications

Meets all EIA-468-B 1994 Standards

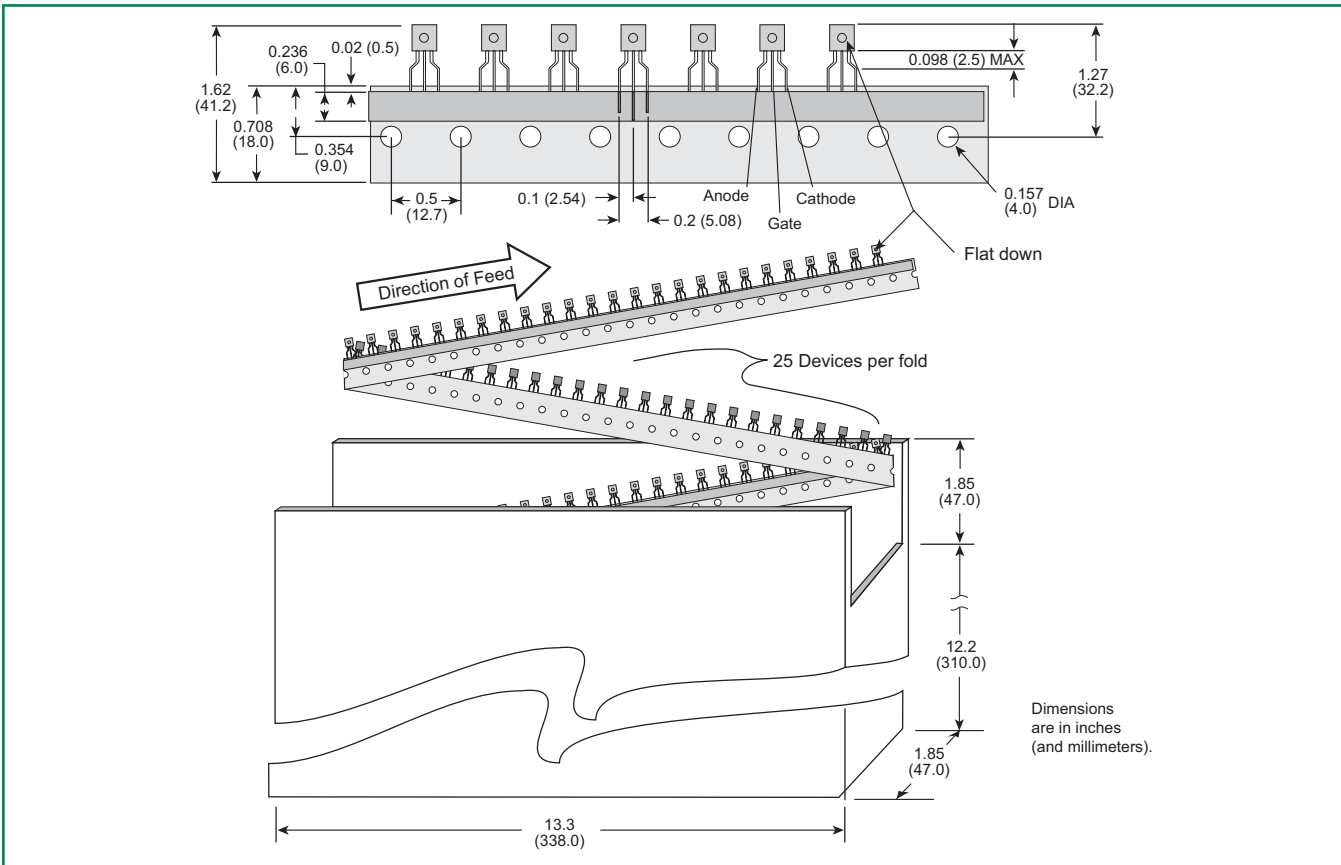

Compak Embossed Carrier Reel Pack (RP) Specifications

Meets all EIA-481-1 Standards

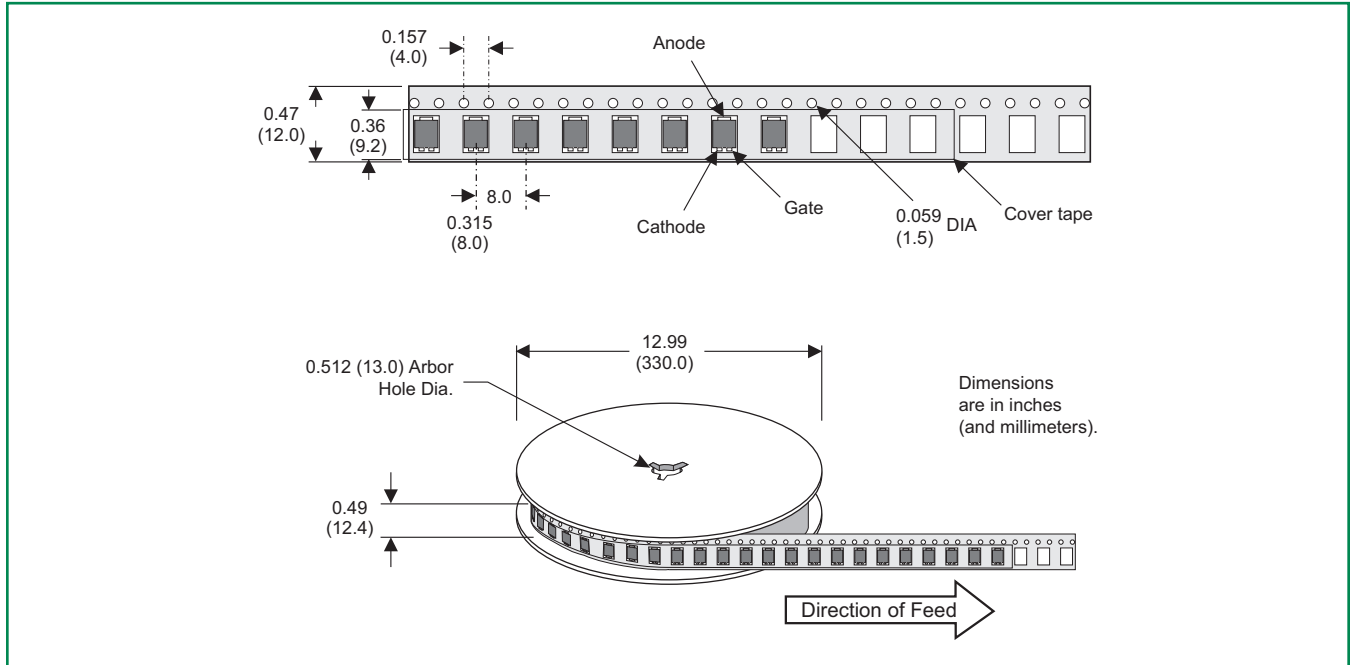

Part Numbering System

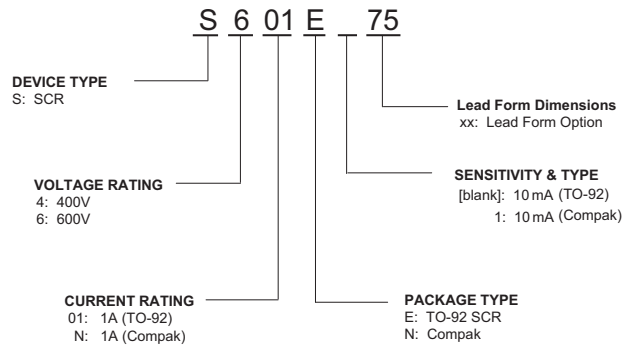

Part Marking System

TO-92 (E Package)

Compak (C Package)

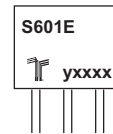

1.0A SCRs

单击下面可查看定价，库存，交付和生命周期等信息

[>>Littelfuse\(美国力特\)](#)