

1KSMB Series

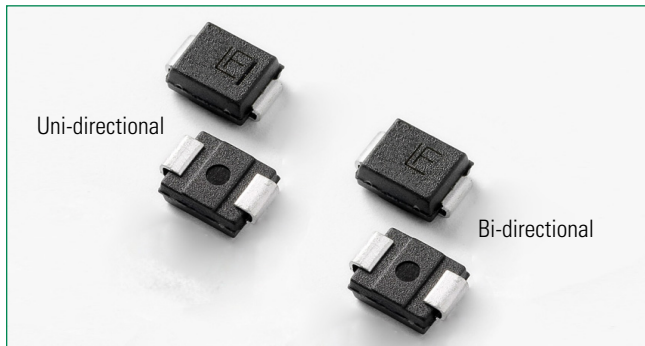

Agency Approvals

Agency	Agency File Number
	E230531

Maximum Ratings and Thermal Characteristics (T_A=25°C unless otherwise noted)

Parameter	Symbol	Value	Unit
Peak Pulse Power Dissipation at T _A =25°C by 10/1000µs Waveform (Fig.2)(Note 1), (Note 2)	P _{PPM}	1000	W
Power Dissipation on Infinite Heat Sink at T _L =50°C	P _D	5.0	W
Peak Forward Surge Current, 8.3ms Single Half Sine Wave (Note 3)	I _{FSM}	120	A
Maximum Instantaneous Forward Voltage at 50A for Unidirectional Only	V _F	3.5	V
Operating Temperature Range	T _J	-65 to 150	°C
Storage Temperature Range	T _{STG}	-65 to 175	°C
Typical Thermal Resistance Junction to Lead	R _{θJL}	20	°C/W
Typical Thermal Resistance Junction to Ambient	R _{θJA}	100	°C/W

Notes:
 1. Non-repetitive current pulse, per Fig. 4 and derated above T_J (initial) =25°C per Fig. 3.
 2. Mounted on copper pad area of 0.2x0.2" (5.0 x 5.0mm) to each terminal.
 3. Measured on 8.3ms single half sine wave or equivalent square wave for unidirectional device only, duty cycle=4 per minute maximum.

Functional Diagram

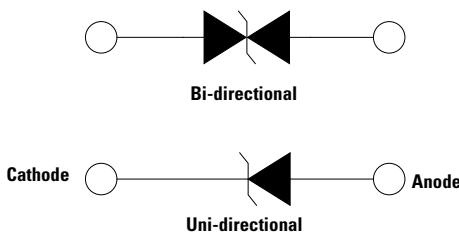

Description

The 1KSMB series is designed specifically to protect sensitive electronic equipment from voltage transients induced by lightning and other transient voltage events.

Features

- 1000W peak pulse power capability at 10/1000µs waveform, repetition rate (duty cycles):0.01 %
- For surface mounted applications to optimize board space
- Low profile package
- Typical failure mode is short from over-specified voltage or current
- Whisker test is conducted based on JEDEC JESD201A per its table 4a and 4c
- IEC-61000-4-2 ESD 30kV(Air), 30kV (Contact)
- ESD protection of data lines in accordance with IEC 61000-4-2
- EFT protection of data lines in accordance with IEC 61000-4-4
- Built-in strain relief
- V_{BR} @ T_J = V_{BR} @25°C x (1+αT x (T_J - 25)) (αT: Temperature Coefficient, typical value is 0.1 %)
- Glass passivated chip junction
- Fast response time: typically less than 1.0ps from 0V to BV min
- Excellent clamping capability
- Low incremental surge resistance
- Typical I_R less than 1µA when V_{BR} max>12V
- High temperature to reflow soldering guaranteed: 260°C/40sec
- Plastic package is flammability rated V-0 per Underwriters Laboratories
- Meet MSL level1, per J-STD-020, LF maximum peak of 260°C
- Matte tin lead-free Plated
- Available in breakdown Voltage from 6.8V to 180V specially designed for automotive applications
- Offers high-surge rating in compact package: bridges the gap between 600W and 1.5KW
- Halogen free and RoHS compliant
- Pb-free E3 means 2nd level interconnect is Pb-free and the terminal finish material is tin(Sn) (IPC/JEDEC J-STD-609A.01)

Applications

TVS devices are ideal for the protection of I/O Interfaces, V_{CC} bus and other vulnerable circuits used in Telecom, Computer, Industrial and Consumer electronic applications.

Additional Information



Electrical Characteristics (T_A=25°C unless otherwise noted)

Part Number (Uni)	Part Number (Bi)	Marking		Reverse Stand off Voltage V _R (Volts)	Breakdown Voltage V _{BR} (Volts) @ I _T		Test Current I _T (mA)	Maximum Clamping Voltage V _C @ I _{PP} (V)	Maximum Peak Pulse Current I _{PP} (A)	Maximum Reverse Leakage I _R @ V _R (μA)	Agency Approval 
					Min.	Max.					
		Uni	Bi								
1KSMB6.8A	1KSMB6.8CA	A10A	N10A	5.80	6.45	7.14	10	10.5	95.2	900	x
1KSMB7.5A	1KSMB7.5CA	A10B	N10B	6.40	7.13	7.88	10	11.3	88.5	400	x
1KSMB8.2A	1KSMB8.2CA	A10C	N10C	7.02	7.79	8.61	10	12.1	82.6	180	x
1KSMB9.1A	1KSMB9.1CA	A10D	N10D	7.78	8.65	9.55	1	13.4	74.6	45	x
1KSMB10A	1KSMB10CA	A10E	N10E	8.55	9.50	10.50	1	14.5	69.0	8	x
1KSMB11A	1KSMB11CA	A10F	N10F	9.40	10.50	11.60	1	15.6	64.1	4	x
1KSMB12A	1KSMB12CA	A10G	N10G	10.20	11.40	12.60	1	16.7	59.9	1	x
1KSMB13A	1KSMB13CA	A10H	N10H	11.10	12.40	13.70	1	18.2	54.9	1	x
1KSMB15A	1KSMB15CA	A10I	N10I	12.80	14.30	15.80	1	21.2	47.2	1	x
1KSMB16A	1KSMB16CA	A10J	N10J	13.60	15.20	16.80	1	22.5	44.4	1	x
1KSMB18A	1KSMB18CA	A10K	N10K	15.30	17.10	18.90	1	25.5	39.2	1	x
1KSMB20A	1KSMB20CA	A10L	N10L	17.10	19.00	21.00	1	27.7	36.1	1	x
1KSMB22A	1KSMB22CA	A10M	N10M	18.80	20.90	23.10	1	30.6	32.7	1	x
1KSMB24A	1KSMB24CA	A10N	N10N	20.50	22.80	25.20	1	33.2	30.1	1	x
1KSMB27A	1KSMB27CA	A10O	N10O	23.10	25.70	28.40	1	37.5	26.7	1	x
1KSMB30A	1KSMB30CA	A10P	N10P	25.60	28.50	31.50	1	41.4	24.2	1	x
1KSMB33A	1KSMB33CA	A10Q	N10Q	28.20	31.40	34.70	1	45.7	21.9	1	x
1KSMB36A	1KSMB36CA	A10R	N10R	30.80	34.20	37.80	1	49.9	20.0	1	x
1KSMB39A	1KSMB39CA	A10S	N10S	33.30	37.10	41.00	1	53.9	18.6	1	x
1KSMB43A	1KSMB43CA	A10T	N10T	36.80	40.90	45.20	1	59.3	16.9	1	x
1KSMB47A	1KSMB47CA	A10U	N10U	40.20	44.70	49.40	1	64.8	15.4	1	x
1KSMB51A	1KSMB51CA	A10V	N10V	43.60	48.50	53.60	1	70.1	14.3	1	x
1KSMB56A	1KSMB56CA	A10W	N10W	47.80	53.20	58.80	1	77.0	13.0	1	x
1KSMB62A	1KSMB62CA	A10X	N10X	53.00	58.90	65.10	1	85.0	11.8	1	x
1KSMB68A	1KSMB68CA	A10Y	N10Y	58.10	64.60	71.40	1	92.0	10.9	1	x
1KSMB75A	1KSMB75CA	A10Z	N10Z	64.10	71.30	78.80	1	103.0	9.7	1	x
1KSMB82A	1KSMB82CA	B10A	O10A	70.10	77.90	86.10	1	113.0	8.8	1	x
1KSMB91A	1KSMB91CA	B10B	O10B	77.80	86.50	95.50	1	125.0	8.0	1	x
1KSMB100A	1KSMB100CA	B10C	O10C	85.50	95.00	105.00	1	137.0	7.3	1	x
1KSMB110A	1KSMB110CA	B10D	O10D	94.00	105.00	116.00	1	152.0	6.6	1	x
1KSMB120A	1KSMB120CA	B10E	O10E	102.00	114.00	126.00	1	165.0	6.1	1	x
1KSMB130A	1KSMB130CA	B10F	O10F	111.00	124.00	137.00	1	179.0	5.6	1	x
1KSMB150A	1KSMB150CA	B10G	O10G	128.00	143.00	158.00	1	207.0	4.8	1	x
1KSMB160A	1KSMB160CA	B10H	O10H	136.00	152.00	168.00	1	219.0	4.6	1	x
1KSMB170A	1KSMB170CA	B10I	O10I	144.50	162.00	179.00	1	234.0	4.3	1	x
1KSMB180A	1KSMB180CA	B10J	O10J	153.00	171.00	189.00	1	246.0	4.1	1	x

For bidirectional type having V_s of 10 volts and less, the I_s limit is double.

For parts without A V_{min} is ± 10% and V_C is 5% higher than with A parts, the parts without A are currently available, but not recommended for new designs. The parts with A are preferred.

I-V Curve Characteristics

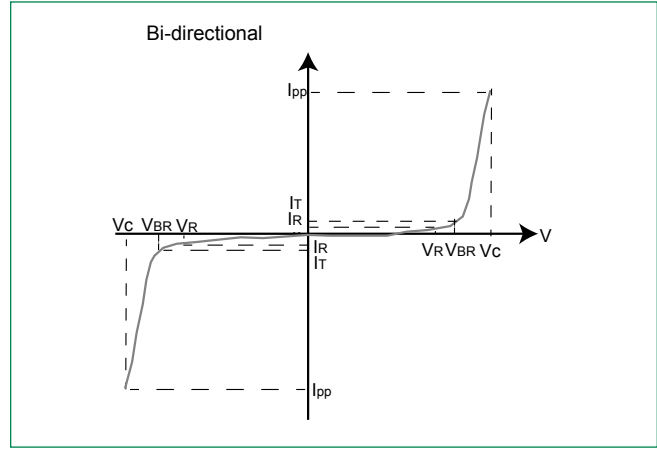
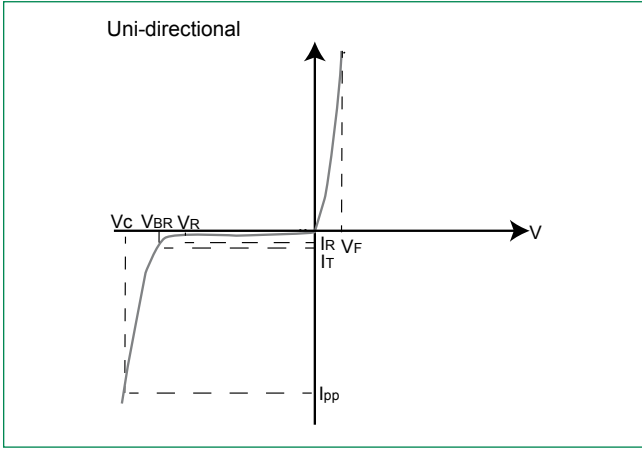

- P_{PPM} Peak Pulse Power Dissipation** – Max power dissipation
- V_R Stand-off Voltage** – Maximum voltage that can be applied to the TVS without operation
- V_{BR} Breakdown Voltage** – Maximum voltage that flows through the TVS at a specified test current (I_T)
- V_C Clamping Voltage** – Peak voltage measured across the TVS at a specified I_{ppm} (peak impulse current)
- I_R Reverse Leakage Current** – Current measured at V_R
- V_F Forward Voltage Drop for Uni-directional**

Ratings and Characteristic Curves ($T_A=25^\circ\text{C}$ unless otherwise noted)

Figure 1 - TVS Transients Clamping Waveform

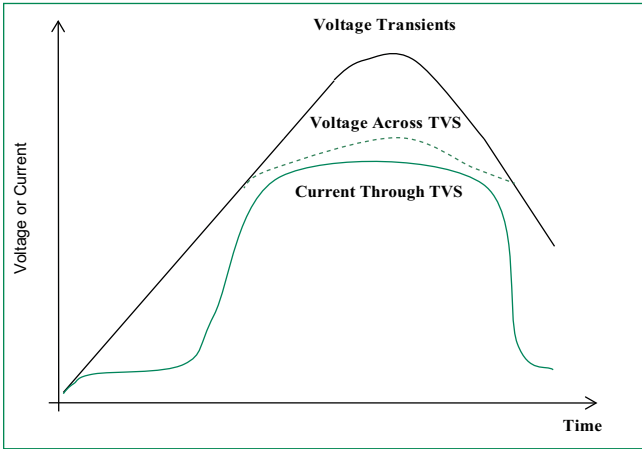
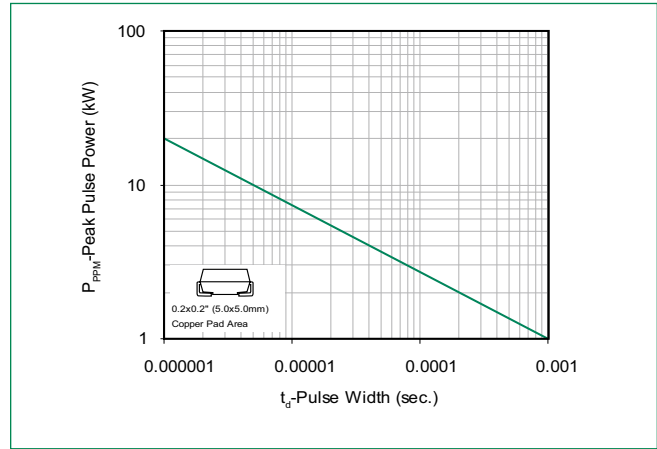

Figure 2 - Peak Pulse Power Rating Curve



Ratings and Characteristic Curves ($T_A=25^\circ\text{C}$ unless otherwise noted) (Continued)

Figure 3 - Peak Pulse Power Derating Curve

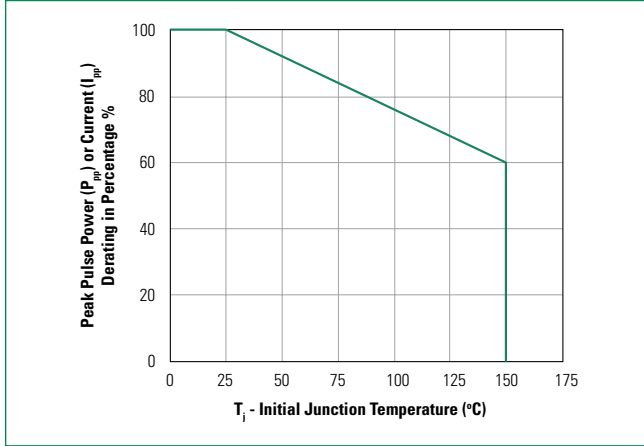

Figure 4 - Pulse Waveform

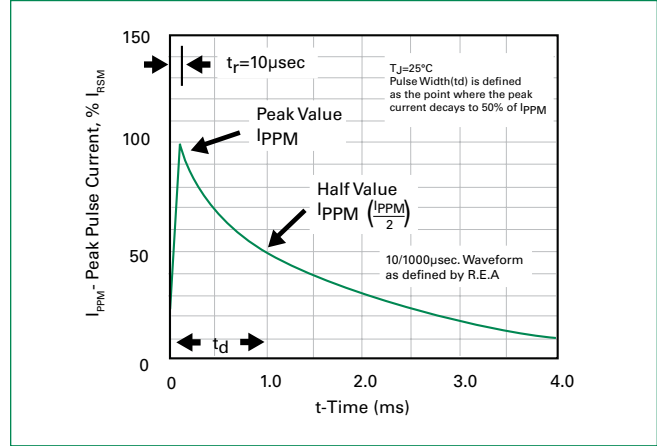

Figure 5 - Typical Junction Capacitance

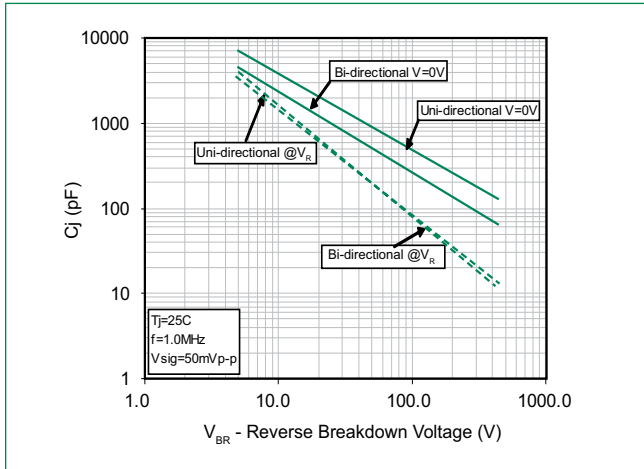

Figure 6 - Typical Transient Thermal Impedance

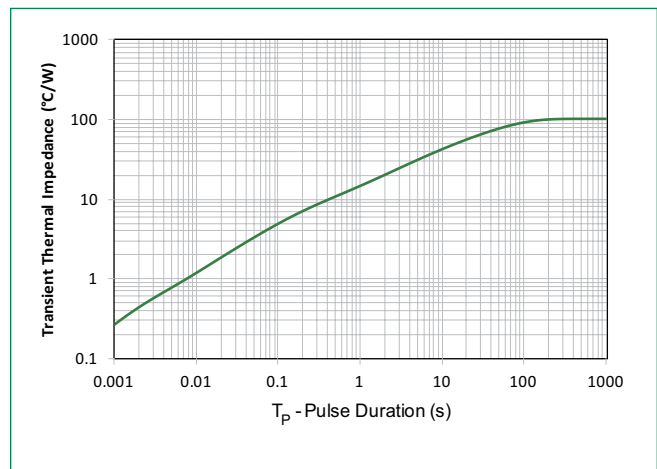

Figure 7 - Maximum Non-Repetitive Peak Forward Surge Current Uni-Directional Only

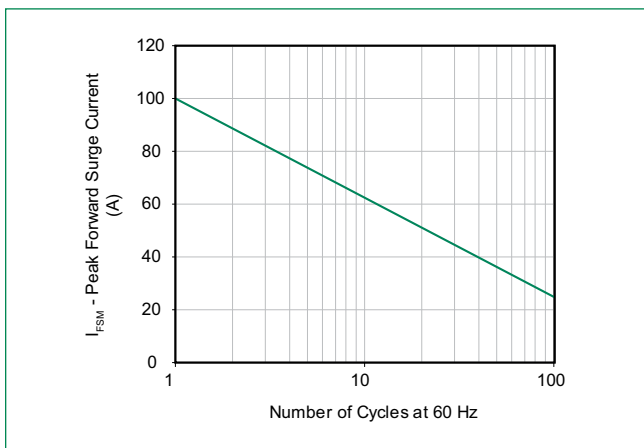
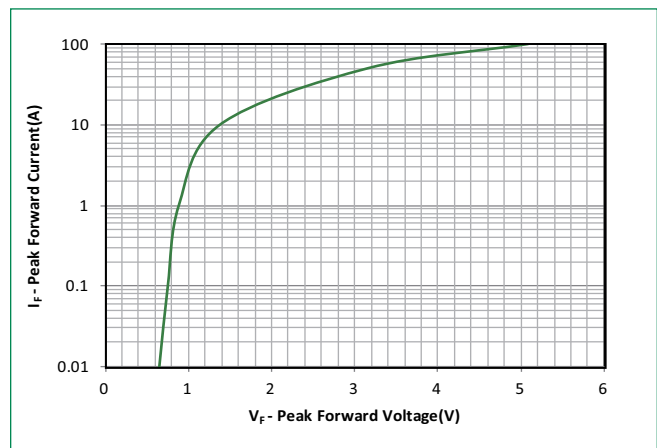
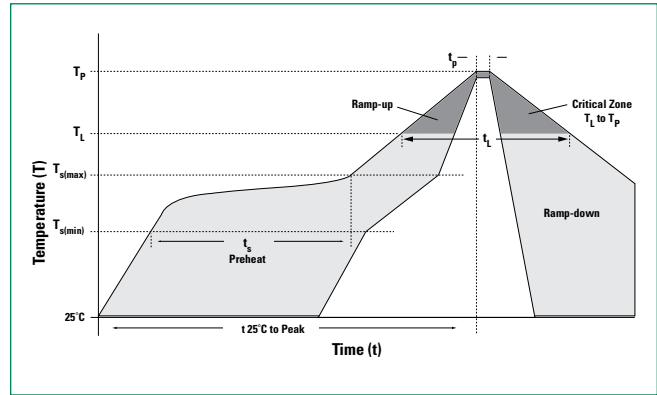

Figure 8 - Peak Forward Voltage Drop vs Peak Forward Current (Typical Values)



Soldering Parameters

Reflow Condition		Lead-free assembly
Pre Heat	- Temperature Min ($T_{s(min)}$)	150°C
	- Temperature Max ($T_{s(max)}$)	200°C
	- Time (min to max) (t_s)	60 – 180 secs
Average ramp up rate (Liquidus Temp (T_A) to peak)		3°C/second max
$T_{S(max)}$ to T_A - Ramp-up Rate		3°C/second max
Reflow	- Temperature (T_A) (Liquidus)	217°C
	- Time (min to max) (t_s)	60 – 150 seconds
Peak Temperature (T_p)		260 ^{+0/-5} °C
Time within 5°C of actual peak Temperature (t_p)		20 – 40 seconds
Ramp-down Rate		6°C/second max
Time 25°C to peak Temperature (T_p)		8 minutes Max.
Do not exceed		260°C



Physical Specifications

Weight	0.003 ounce, 0.093 grams
Case	JEDEC DO214AA. Molded plastic body over glass passivated junction
Polarity	Color band denotes cathode except Bidirectional.
Terminal	Matte Tin-plated leads, Solderable per JESD22-B102

Environmental Specifications

High Temp. Storage	JESD22-A103
HTRB	JESD22-A108
Temperature Cycling	JESD22-A104
MSL	JEDEC-J-STD-020, Level 1
H3TRB	JESD22-A101
RSH	JESD22-A111

Dimensions

D0-214AA (SMB J-Bend)

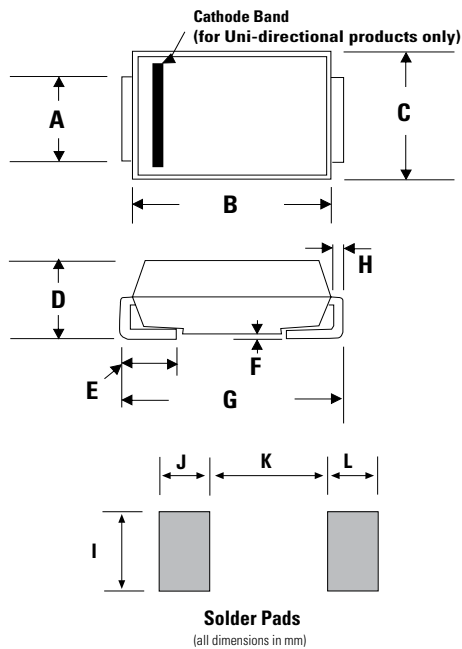

Dimensions	Inches		Millimeters	
	Min	Max	Min	Max
A	0.077	0.086	1.950	2.200
B	0.160	0.180	4.060	4.570
C	0.130	0.155	3.300	3.940
D	0.084	0.096	2.130	2.440
E	0.030	0.060	0.760	1.520
F	-	0.008	-	0.203
G	0.205	0.220	5.210	5.590
H	0.006	0.012	0.152	0.305
I	0.089	-	2.260	-
J	0.085	-	2.160	-
K	-	0.107	-	2.740
L	0.085	-	2.160	-

Part Numbering System

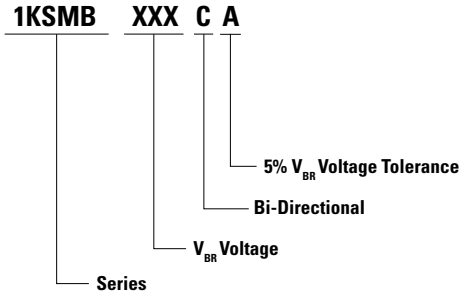

Part Marking System

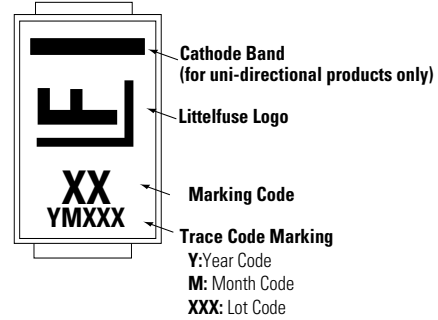

Packaging

Part number	Component Package	Quantity	Packaging Option	Packaging Specification
1KSMBxxxXX	DO-214AA	3000	Tape & Reel - 12mm tape/13" reel	EIA STD RS-481

Tape and Reel Specification

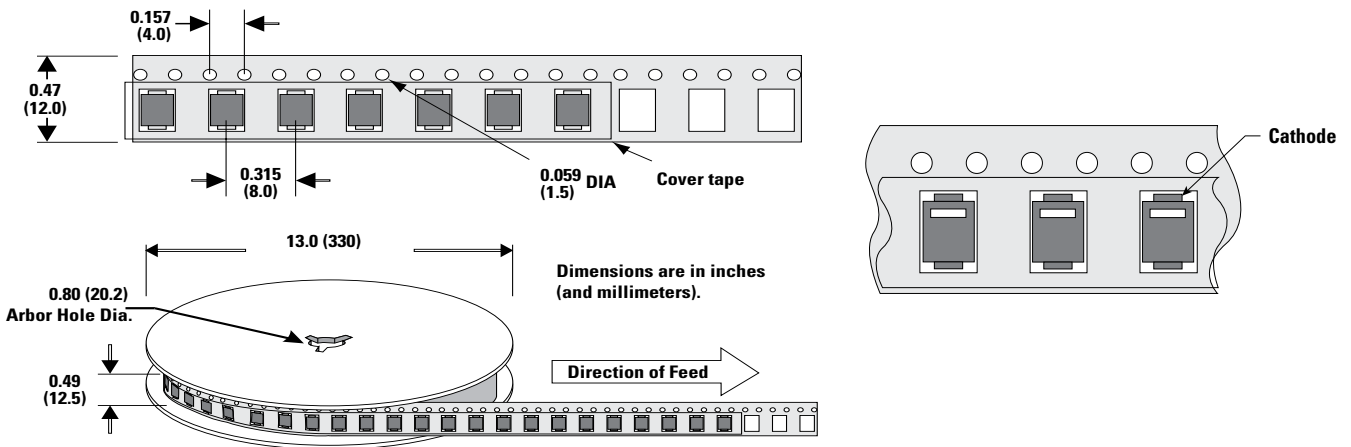

Disclaimer Notice - Information furnished is believed to be accurate and reliable. However, users should independently evaluate the suitability of and test each product selected for their own applications. Littelfuse products are not designed for, and may not be used in, all applications. Read complete Disclaimer Notice at www.littelfuse.com/disclaimer-electronics.

© 2021 Littelfuse, Inc.
Specifications are subject to change without notice.
Revised: BA.04/20/21

单击下面可查看定价，库存，交付和生命周期等信息

[>>Littelfuse\(美国力特\)](#)