

X3-Class HiPerFET™ Power MOSFET

IXFP36N20X3M

$V_{DSS} = 200V$
 $I_{D25} = 36A$
 $R_{DS(on)} \leq 45m\Omega$

(Electrically Isolated Tab)

N-Channel Enhancement Mode

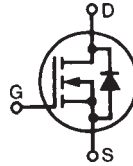

OVERMOLDED
TO-220

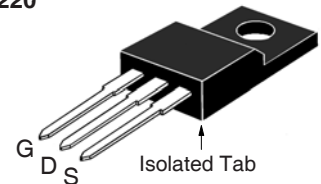

G = Gate D = Drain
S = Source

Symbol	Test Conditions	Maximum Ratings	
V_{DSS}	$T_J = 25^\circ C$ to $150^\circ C$	200	V
V_{DGR}	$T_J = 25^\circ C$ to $150^\circ C$, $R_{GS} = 1M\Omega$	200	V
V_{GSS}	Continuous	± 20	V
V_{GSM}	Transient	± 30	V
I_{D25}	$T_C = 25^\circ C$, Limited by T_{JM}	36	A
I_{DM}	$T_C = 25^\circ C$, Pulse Width Limited by T_{JM}	50	A
I_A	$T_C = 25^\circ C$	18	A
E_{AS}	$T_C = 25^\circ C$	300	mJ
dv/dt	$I_S \leq I_{DM}$, $V_{DD} \leq V_{DSS}$, $T_J \leq 150^\circ C$	20	V/ns
P_D	$T_C = 25^\circ C$	36	W
T_J		-55 ... +150	$^\circ C$
T_{JM}		150	$^\circ C$
T_{stg}		-55 ... +150	$^\circ C$
T_L	Maximum Lead Temperature for Soldering	300	$^\circ C$
T_{SOLD}	1.6 mm (0.062in.) from Case for 10s	260	$^\circ C$
V_{ISOL}	50/60 Hz, 1 Minute	2500	V~
M_d	Mounting Torque	1.13 / 10	Nm/lb.in
Weight		2.5	g

Features

- International Standard Package
- Plastic Overmolded Tab
- Low $R_{DS(ON)}$ and Q_G
- Avalanche Rated
- 2500V~ Electrical Isolation
- Low Package Inductance

Advantages

- High Power Density
- Easy to Mount
- Space Savings

Applications

- Switch-Mode and Resonant-Mode Power Supplies
- DC-DC Converters
- PFC Circuits
- AC and DC Motor Drives
- Robotics and Servo Controls

Symbol	Test Conditions ($T_J = 25^\circ C$, Unless Otherwise Specified)	Characteristic Values		
		Min.	Typ.	Max.
BV_{DSS}	$V_{GS} = 0V$, $I_D = 250\mu A$	200		V
$V_{GS(th)}$	$V_{DS} = V_{GS}$, $I_D = 500\mu A$	2.5		4.5 V
I_{GSS}	$V_{GS} = \pm 20V$, $V_{DS} = 0V$			± 100 nA
I_{DSS}	$V_{DS} = V_{DSS}$, $V_{GS} = 0V$ $T_J = 125^\circ C$			5 μA 100 μA
$R_{DS(on)}$	$V_{GS} = 10V$, $I_D = 18A$, Note 1		38	45 m Ω

Symbol	Test Conditions ($T_J = 25^\circ\text{C}$, Unless Otherwise Specified)	Characteristic Values		
		Min.	Typ.	Max
g_{fs}	$V_{DS} = 10\text{V}$, $I_D = 18\text{A}$, Note 1	16	26	S
R_{Gi}	Gate Input Resistance		1.6	Ω
C_{iss}	$V_{GS} = 0\text{V}$, $V_{DS} = 25\text{V}$, $f = 1\text{MHz}$		1425	pF
C_{oss}			280	pF
C_{rss}			1.2	pF
Effective Output Capacitance				
$C_{o(er)}$	Energy related	$V_{GS} = 0\text{V}$ $V_{DS} = 0.8 \cdot V_{DSS}$	130	pF
$C_{o(tr)}$	Time related		400	pF
$t_{d(on)}$	Resistive Switching Times $V_{GS} = 10\text{V}$, $V_{DS} = 0.5 \cdot V_{DSS}$, $I_D = 18\text{A}$ $R_G = 30\Omega$ (External)		19	ns
t_r			30	ns
$t_{d(off)}$			54	ns
t_f			20	ns
$Q_{g(on)}$	$V_{GS} = 10\text{V}$, $V_{DS} = 0.5 \cdot V_{DSS}$, $I_D = 18\text{A}$		21	nC
Q_{gs}			8	nC
Q_{gd}			7	nC
R_{thJC}				3.5 $^\circ\text{C/W}$
R_{thCS}		0.50		$^\circ\text{C/W}$

Source-Drain Diode

Symbol	Test Conditions ($T_J = 25^\circ\text{C}$, Unless Otherwise Specified)	Characteristic Values		
		Min.	Typ.	Max
I_S	$V_{GS} = 0\text{V}$			36 A
I_{SM}	Repetitive, Pulse Width Limited by T_{JM}			144 A
V_{SD}	$I_F = I_S$, $V_{GS} = 0\text{V}$, Note 1			1.4 V
t_{rr}	$I_F = 18\text{A}$, $-di/dt = 100\text{A}/\mu\text{s}$ $V_R = 100\text{V}$		75	ns
Q_{RM}			230	nC
I_{RM}			6	A

Note 1. Pulse test, $t \leq 300\mu\text{s}$, duty cycle, $d \leq 2\%$.

OVERMOLDED TO-220 (IXFP...M)

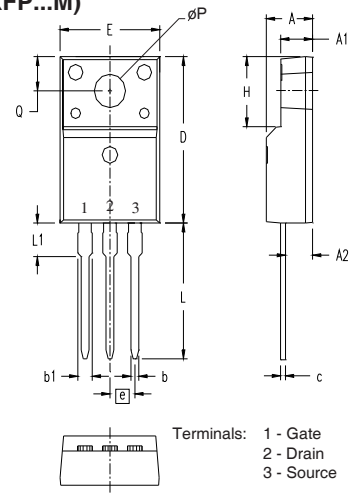

SYM	INCHES		MILLIMETERS	
	MIN	MAX	MIN	MAX
A	.177	.193	4.50	4.90
A1	.092	.108	2.34	2.74
A2	.101	.117	2.56	2.96
b	.028	.035	0.70	0.90
b1	.050	.058	1.27	1.47
c	.018	.024	0.45	0.60
D	.617	.633	15.67	16.07
E	.392	.408	9.96	10.36
e	.100 BSC		2.54 BSC	
H	.255	.271	6.48	6.88
L	.499	.523	12.68	13.28
L1	.119	.135	3.03	3.43
$\emptyset P$.121	.129	3.08	3.28
Q	.126	.134	3.20	3.40

IXYS Reserves the Right to Change Limits, Test Conditions, and Dimensions.

IXYS MOSFETs and IGBTs are covered by one or more of the following U.S. patents:	4,835,592	4,931,844	5,049,961	5,237,481	6,162,665	6,404,065B1	6,683,344	6,727,585	7,005,734B2	7,157,338B2
	4,860,072	5,017,508	5,063,307	5,381,025	6,259,123B1	6,534,343	6,710,405B2	6,759,692	7,063,975B2	
	4,881,106	5,034,796	5,187,117	5,486,715	6,306,728B1	6,583,505	6,710,463	6,771,478B2	7,071,537	

Fig. 1. Output Characteristics @ $T_J = 25^\circ\text{C}$

Fig. 2. Extended Output Characteristics @ $T_J = 25^\circ\text{C}$

Fig. 3. Output Characteristics @ $T_J = 125^\circ\text{C}$

Fig. 4. $R_{DS(on)}$ Normalized to $I_D = 18\text{A}$ Value vs. Junction Temperature

Fig. 5. $R_{DS(on)}$ Normalized to $I_D = 18\text{A}$ Value vs. Drain Current

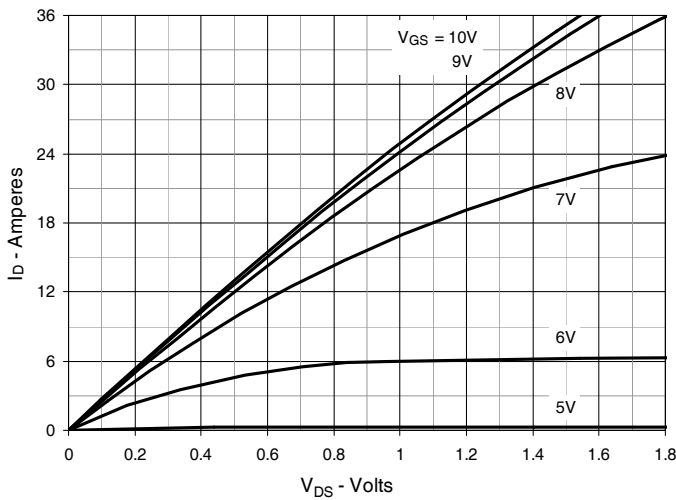
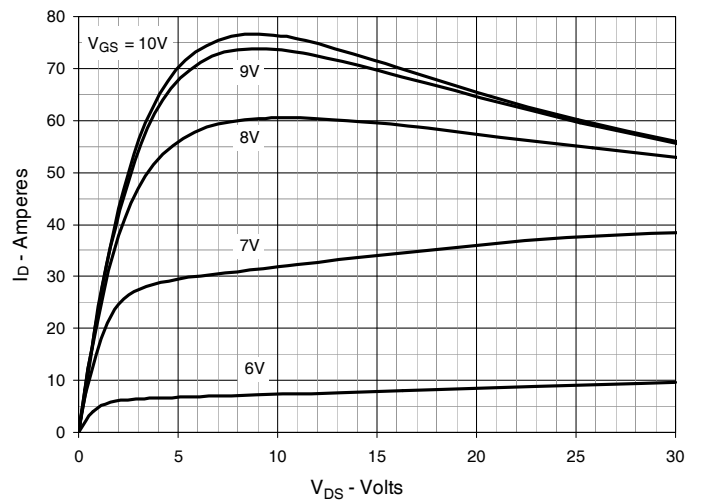
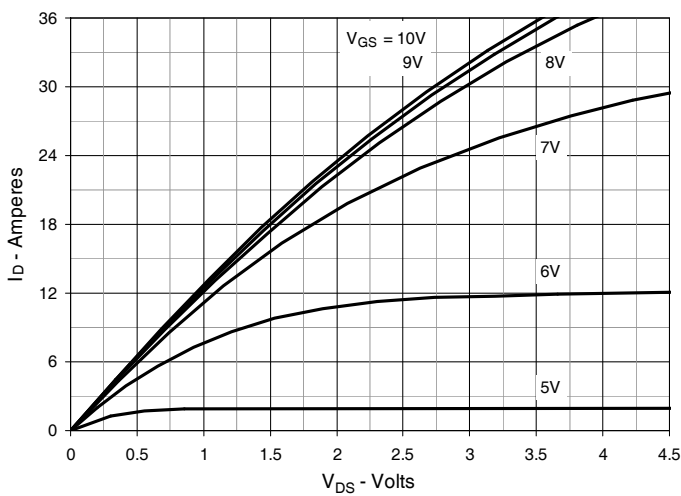
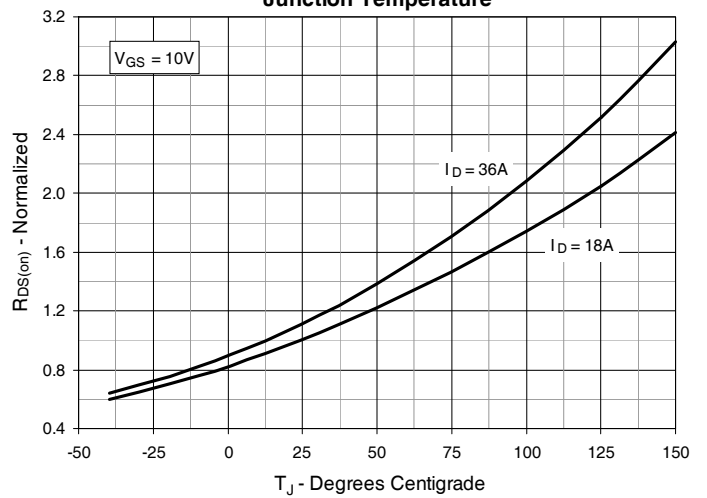
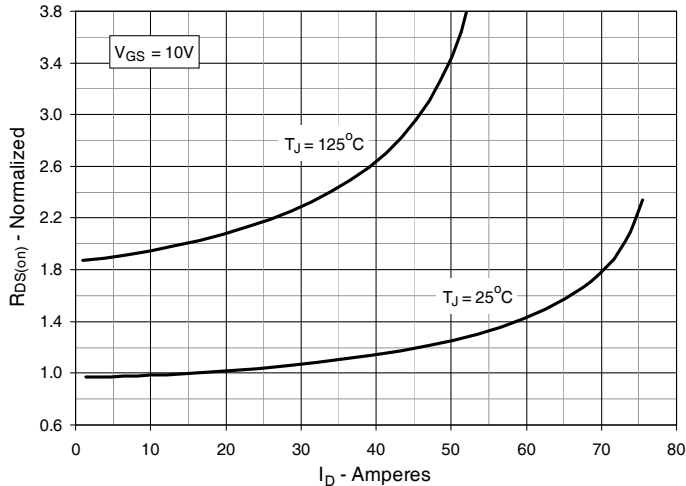
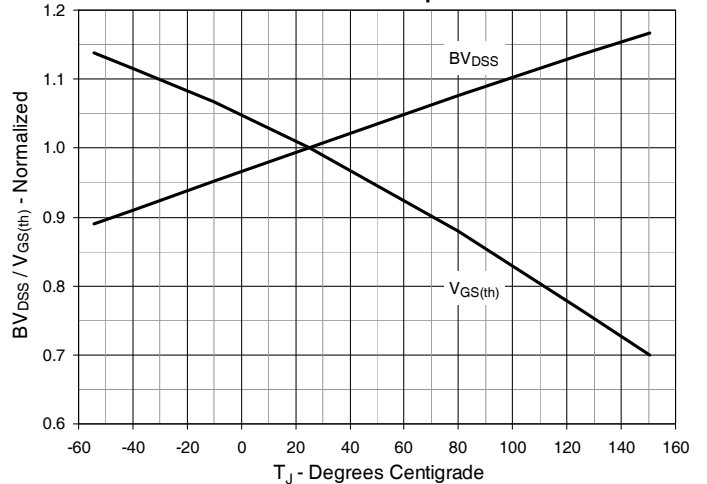
Fig. 6. Normalized Breakdown & Threshold Voltages vs. Junction Temperature

Fig. 7. Input Admittance

Fig. 8. Transconductance

Fig. 9. Forward Voltage Drop of Intrinsic Diode

Fig. 10. Gate Charge

Fig. 11. Capacitance

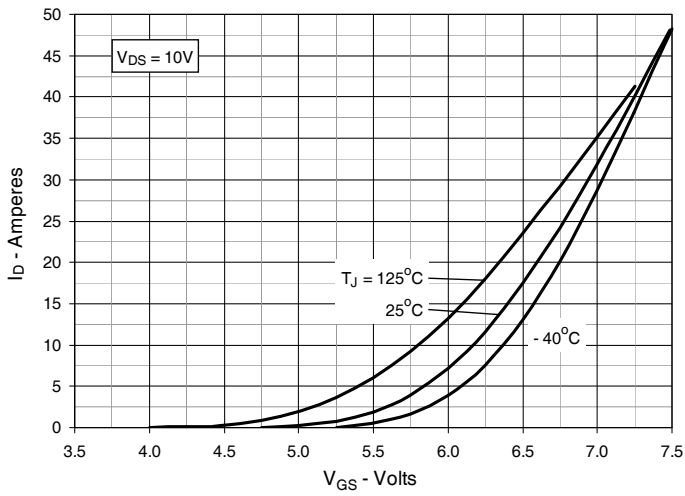
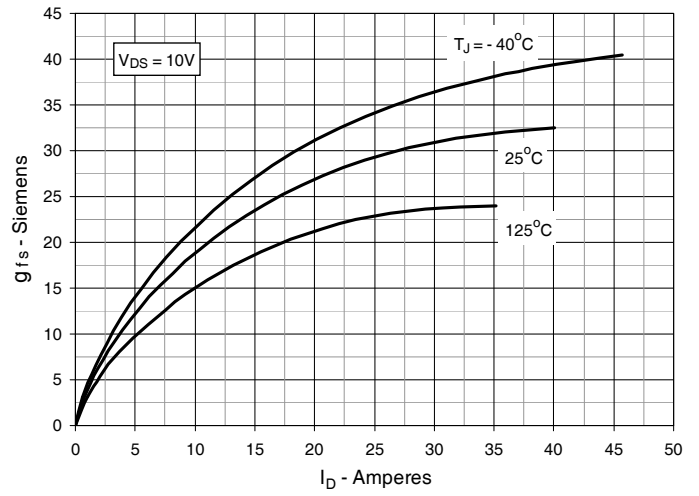
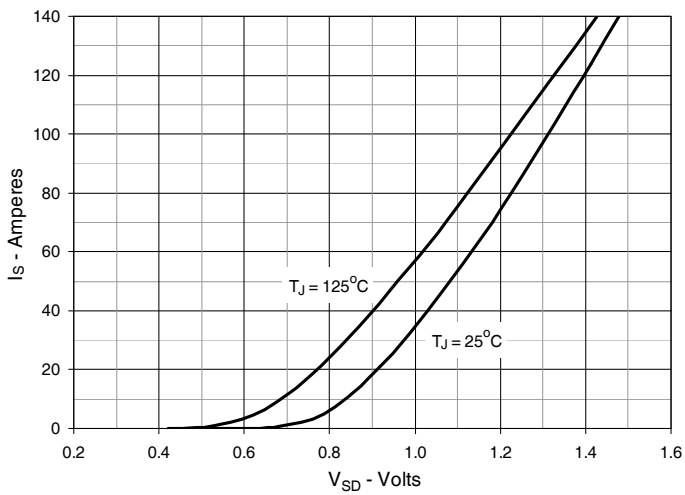
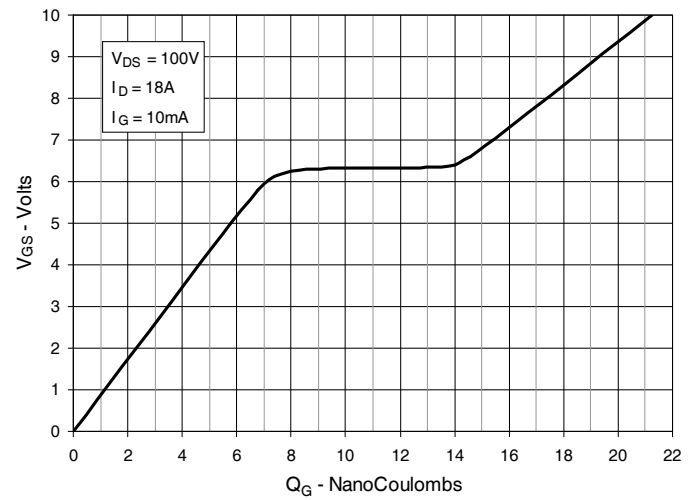
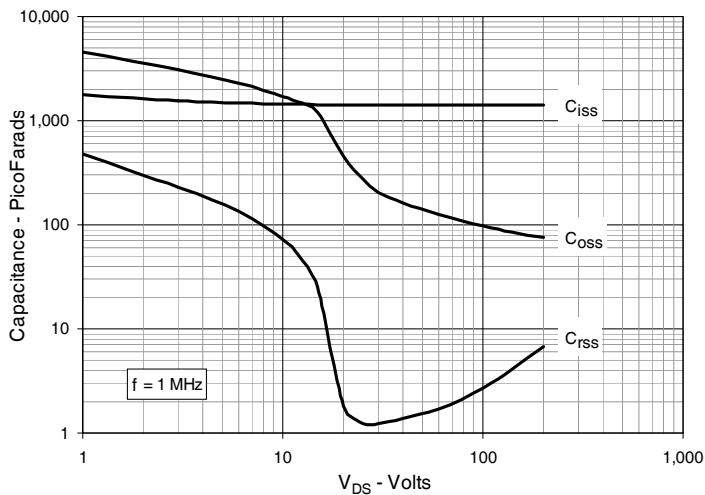
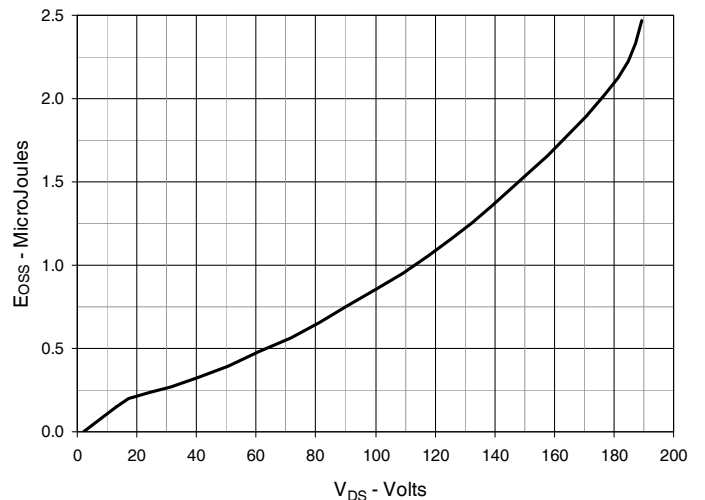
Fig. 12. Output Capacitance Stored Energy

Fig. 13. Forward-Bias Safe Operating Area

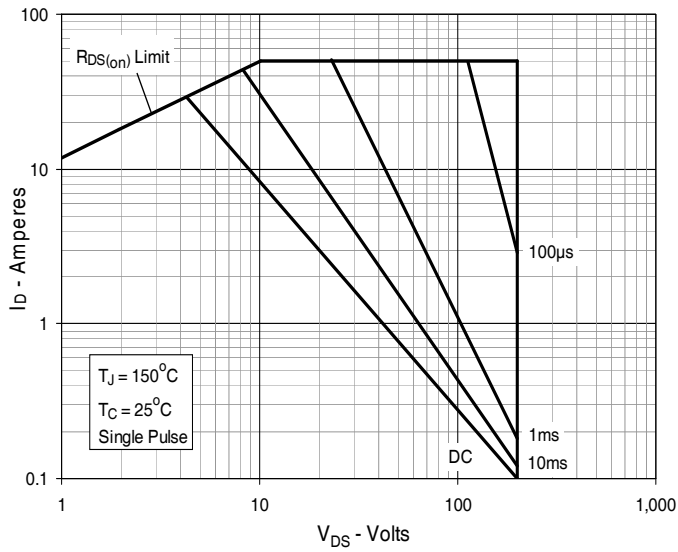
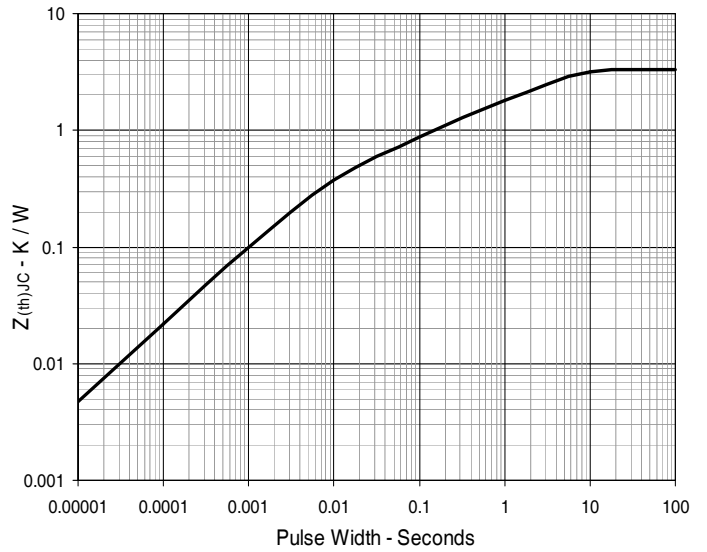

Fig. 14. Maximum Transient Thermal Impedance





Disclaimer Notice - Information furnished is believed to be accurate and reliable. However, users should independently evaluate the suitability of and test each product selected for their own applications. Littelfuse products are not designed for, and may not be used in, all applications. Read complete Disclaimer Notice at www.littelfuse.com/disclaimer-electronics.

IXYS Reserves the Right to Change Limits, Test Conditions, and Dimensions.

单击下面可查看定价，库存，交付和生命周期等信息

[>>Littelfuse\(美国力特\)](#)