

Parameter	Rating	Units
Load Voltage	60	V
Load Current	1	A_{rms} / A_{DC}
On-Resistance (max)	0.4	Ω

Features

- 3750V_{rms} Input/Output Isolation
- Low Drive Power Requirements
- Arc-Free With No Snubbing Circuits
- No EMI/RFI Generation
- Small 8-Pin Package
- Flammability Rating UL 94 V-0
- Surface Mount Version
- Tape & Reel available

Applications

- Telecommunications
- Instrumentation
- Multiplexers
- Data Acquisition
- Electronic Switching
- I/O Subsystems
- Utility Meters (gas, oil, electric and water)
- Medical Equipment-Patient/Equipment Isolation
- Security
- Aerospace
- Industrial Controls

Pin Configuration

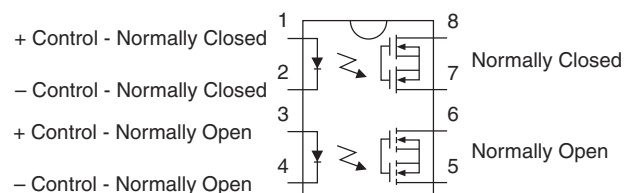

Description

LBA716 is a 60V, 1A, 0.4 Ω dual Solid State Relay integrating independent normally open (1-Form-A) and normally closed (1-Form-B) relays into a single package. It features a superior combination of low on-resistance and enhanced peak load current (5A max.) handling capability.

Approvals

- UL Recognized Component: File # E76270
- CSA Certified Component: Certificate # 1175739
- EN/IEC 60950-1 Certified Component:
Certificate available on our website

Ordering Information

Part #	Description
LBA716	8-Pin DIP (50/Tube)
LBA716S	8-Pin Surface Mount (50/Tube)
LBA716STR	8-Pin Surface Mount (1000/Reel)

Switching Characteristics of Normally Open Devices

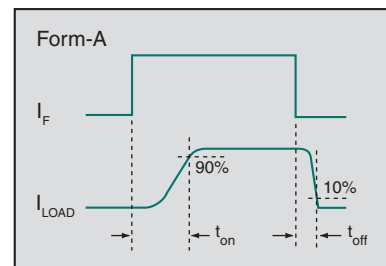

Switching Characteristics of Normally Closed Devices

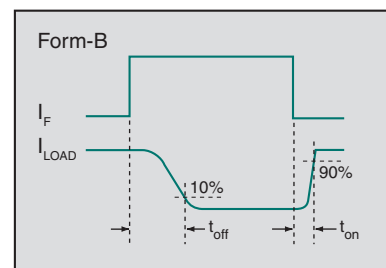

Absolute Maximum Ratings @ 25°C

Parameter	Ratings	Units
Blocking Voltage	60	V _P
Reverse Input Voltage	5	V
Input Control Current	50	mA
Peak (10ms)	1	A
Input Power Dissipation ¹	150	mW
Total Power Dissipation ²	800	mW
Isolation Voltage, Input to Output	3750	V _{rms}
Operational Temperature	-40 to +85	°C
Storage Temperature	-40 to +125	°C

¹ Derate linearly 1.33 mW / °C

² Derate linearly 6.67 mW / °C

Absolute Maximum Ratings are stress ratings. Stresses in excess of these ratings can cause permanent damage to the device. Functional operation of the device at conditions beyond those indicated in the operational sections of this data sheet is not implied.

Typical values are characteristic of the device at +25°C, and are the result of engineering evaluations. They are provided for information purposes only, and are not part of the manufacturing testing requirements.

Electrical Characteristics @ 25°C

Parameter	Conditions	Symbol	Min	Typ	Max	Units
Characteristics: Form-A (Normally Open)						
Load Current						
Continuous	-	I _L	-	-	1	A _{rms} / A _{DC}
Peak	t ≤ 10ms	I _{LPK}	-	-	±5	A _P
On-Resistance	I _L =1A	R _{ON}	-	0.21	0.4	Ω
Off-State Leakage Current	V _L =60V	I _{LEAK}	-	-	1	μA
Output Capacitance	I _F =0mA, V=50V, f=1MHz	C _{OUT}	-	105	-	pF
Switching Speeds						
Turn-On	I _F =5mA, V _L =10V	t _{on}	-	0.7	5	ms
Turn-Off		t _{off}	-	0.09	5	
Input Control Current to Activate	I _L =1A	I _F	-	-	2	mA
Input Control Current to Deactivate	-	I _F	0.1	-	-	mA
Characteristics: Form-B (Normally Closed)						
Load Current						
Continuous	-	I _L	-	-	0.5	A _{rms} / A _{DC}
Peak	t ≤ 10ms	I _{LPK}	-	-	±1.2	A _P
On-Resistance	I _L =0.5A	R _{ON}	-	1.63	2	Ω
Off-State Leakage Current	V _L =60V, I _F =5mA	I _{LEAK}	-	-	1	μA
Output Capacitance	I _F =2mA, V=50V, f=1MHz	C _{OUT}	-	280	-	pF
Switching Speeds						
Turn-On	I _F =5mA, V _L =10V	t _{on}	-	0.58	5	ms
Turn-Off		t _{off}	-	0.76	5	
Input Control Current to Activate	-	I _F	-	-	2	mA
Input Control Current to Deactivate	I _L =0.5A	I _F	0.1	-	-	mA
Common Characteristics: Form-A and Form-B						
Input Voltage Drop	I _F =5mA	V _F	0.9	1.2	1.5	V
Reverse Input Current	V _R =5V	I _R	-	-	10	μA
Capacitance, Input to Output	V _{IO} =0V, f=1MHz	C _{IO}	-	3	-	pF

*NOTE: If both poles operate simultaneously, then load current must be derated so as not to exceed the package power dissipation value.

Form-A RELAY PERFORMANCE DATA*

Form-A
Typical LED Forward Voltage Drop
(N=50, $I_F=5\text{mA}$)

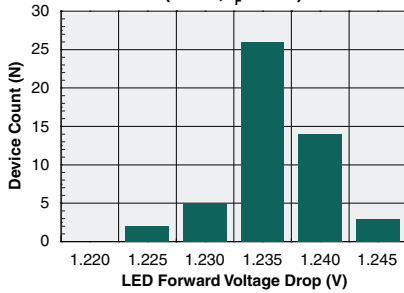

Form-A
Typical Turn-On Time
(N=50, $I_F=5\text{mA}$, $I_L=100\text{mA}$)

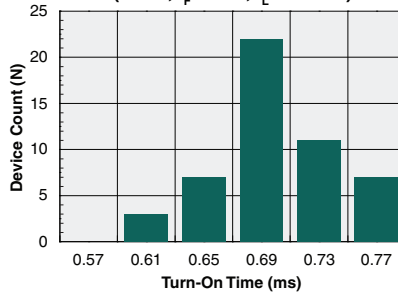

Form-A
Typical Turn-Off Time
(N=50, $I_F=5\text{mA}$, $I_L=100\text{mA}$)

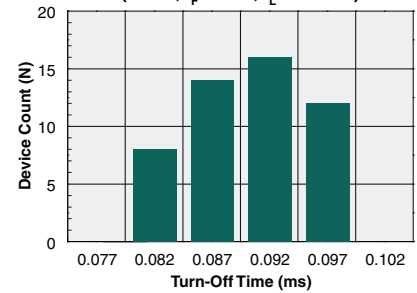

Form-A
Typical I_F for Switch Operation
(N=50, $I_L=200\text{mA}$)

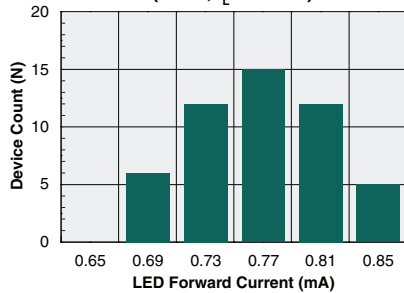

Form-A
Typical On-Resistance
(N=50, $I_F=5\text{mA}$, $I_L=1\text{A}$)

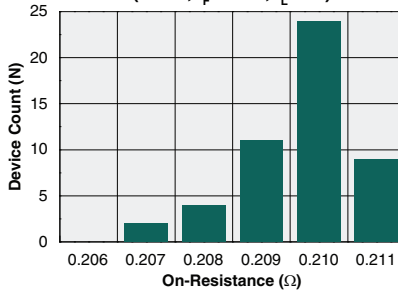

Form-A
Typical Blocking Voltage
(N=50)

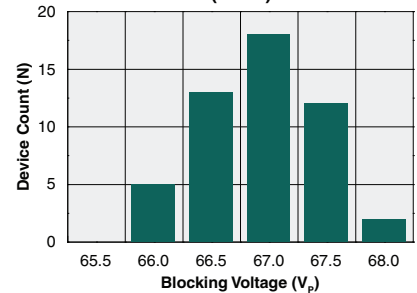

Form-A
Typical I_F for Switch Operation
vs. Temperature
($I_L=200\text{mA}$)

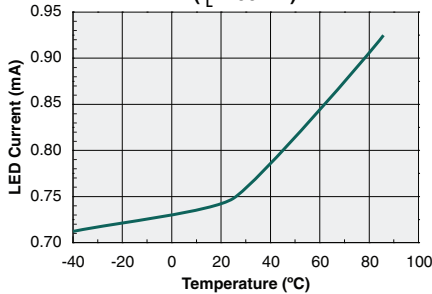

Form-A
Typical Turn-On Time
vs. LED Forward Current
($I_L=100\text{mA}$)

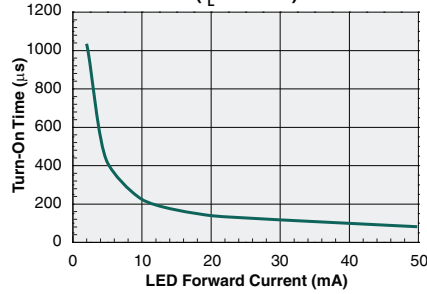

Form-A
Typical Turn-Off Time
vs. LED Forward Current
($I_L=100\text{mA}$)

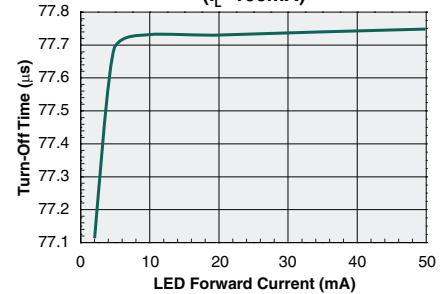

Form-A
Typical Turn-On Time vs. Temperature
($I_L=100\text{mA}$)

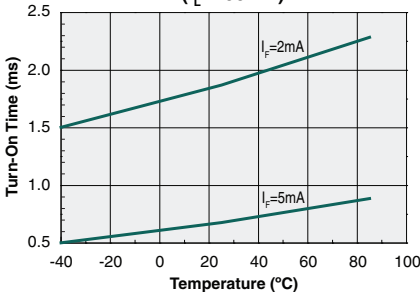

Form-A
Typical Turn-Off Time vs. Temperature
($I_L=100\text{mA}$)

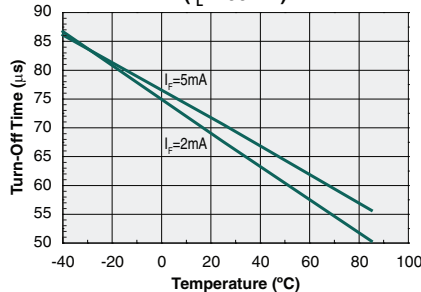

Form-A
Typical On-Resistance (AC)
vs. Temperature
($I_L=500\text{mA}$, $I_F=5\text{mA}$)

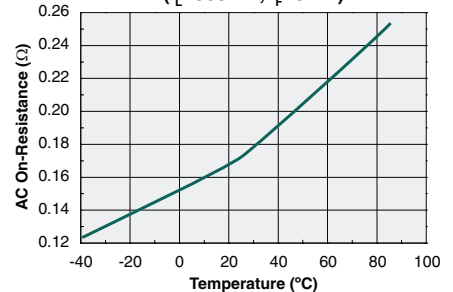

*Unless otherwise noted, data presented in these graphs is typical of device operation at 25°C.
For guaranteed parameters not indicated in the written specifications, please contact our application department.

Form-A RELAY PERFORMANCE DATA*

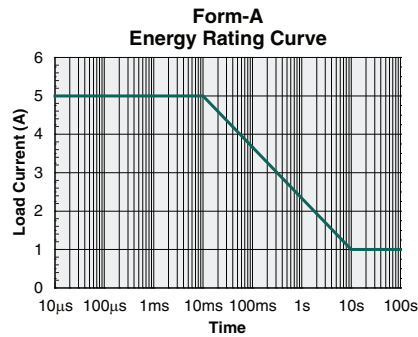
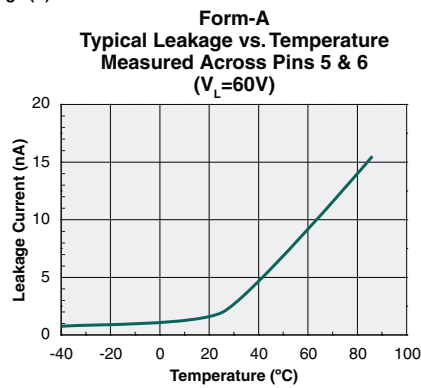
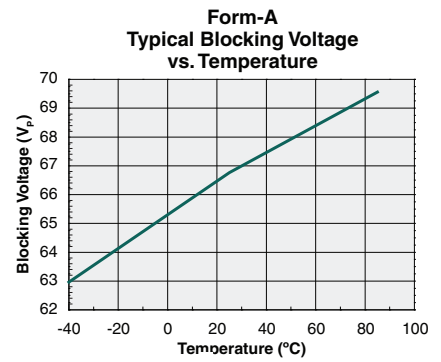
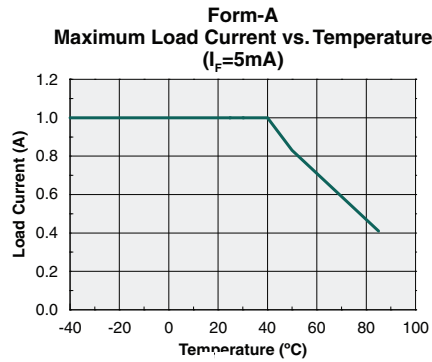
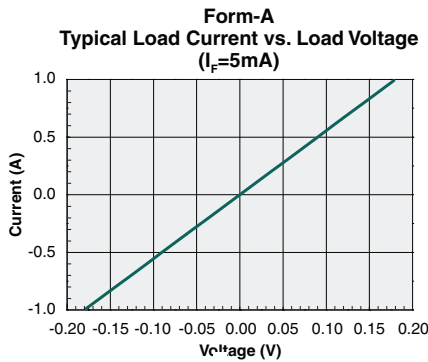

Form-B RELAY PERFORMANCE DATA*

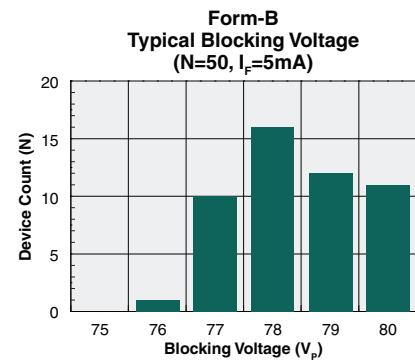
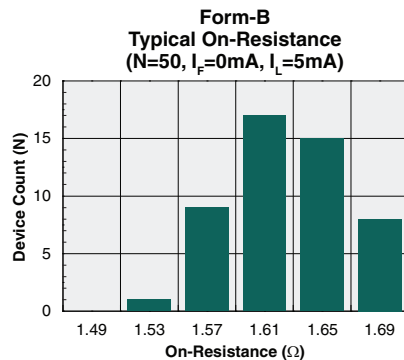
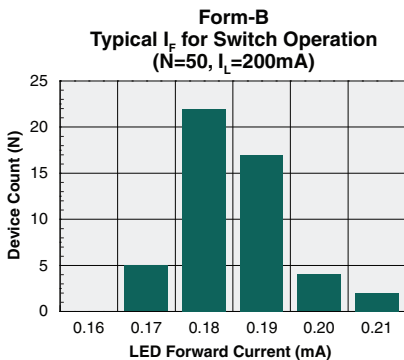
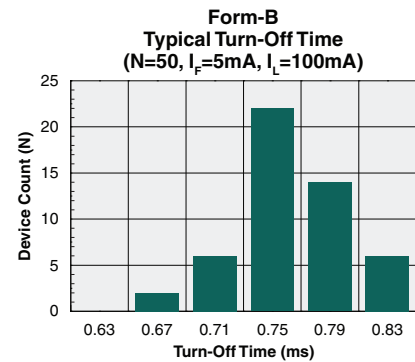
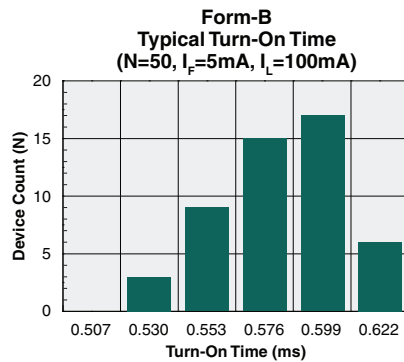
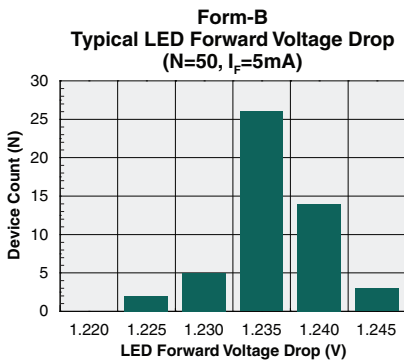

*Unless otherwise noted, data presented in these graphs is typical of device operation at 25°C.
For guaranteed parameters not indicated in the written specifications, please contact our application department.

Form-B RELAY PERFORMANCE DATA*

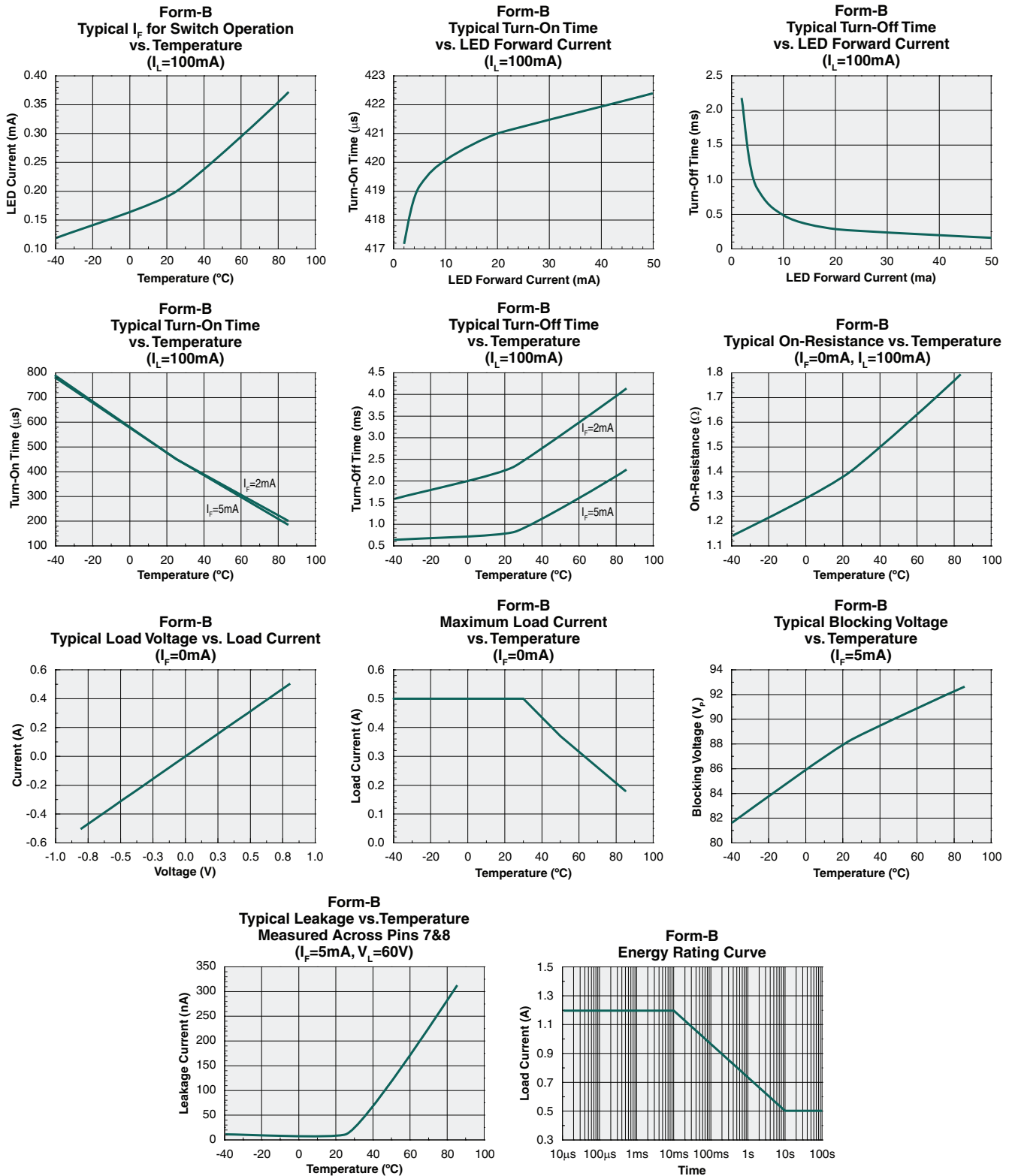

*Unless otherwise noted, data presented in these graphs is typical of device operation at 25 $^{\circ}C$.
For guaranteed parameters not indicated in the written specifications, please contact our application department.

Manufacturing Information

Moisture Sensitivity



All plastic encapsulated semiconductor packages are susceptible to moisture ingress. IXYS Integrated Circuits classifies its plastic encapsulated devices for moisture sensitivity according to the latest version of the joint industry standard, **IPC/JEDEC J-STD-020**, in force at the time of product evaluation. We test all of our products to the maximum conditions set forth in the standard, and guarantee proper operation of our devices when handled according to the limitations and information in that standard as well as to any limitations set forth in the information or standards referenced below.

Failure to adhere to the warnings or limitations as established by the listed specifications could result in reduced product performance, reduction of operable life, and/or reduction of overall reliability.

This product carries a Moisture Sensitivity Level (MSL) classification as shown below, and should be handled according to the requirements of the latest version of the joint industry standard **IPC/JEDEC J-STD-033**.

Device	Moisture Sensitivity Level (MSL) Classification
LBA716 / LBA716S	MSL 1

ESD Sensitivity



This product is **ESD Sensitive**, and should be handled according to the industry standard **JESD-625**.

Soldering Profile

Provided in the table below is the Classification Temperature (T_C) of this product and the maximum dwell time the body temperature of this device may be ($T_C - 5$)°C or greater. The classification temperature sets the Maximum Body Temperature allowed for this device during lead-free reflow processes. For through-hole devices, and any other processes, the guidelines of **J-STD-020** must be observed.

Device	Classification Temperature (T_C)	Dwell Time (t_p)	Max Reflow Cycles
LBA716	250°C	30 seconds	1
LBA716S	250°C	30 seconds	3

Board Wash

IXYS Integrated Circuits recommends the use of no-clean flux formulations. Board washing to reduce or remove flux residue following the solder reflow process is acceptable provided proper precautions are taken to prevent damage to the device. These precautions include, but are not limited to: using a low pressure wash and providing a follow up bake cycle sufficient to remove any moisture trapped within the device due to the washing process. Due to the variability of the wash parameters used to clean the board, determination of the bake temperature and duration necessary to remove the moisture trapped within the package is the responsibility of the user (assembler). Cleaning or drying methods that employ ultrasonic energy may damage the device and should not be used. Additionally, the device must not be exposed to flux or solvents that are Chlorine- or Fluorine-based.



Mechanical Dimensions

LBA716

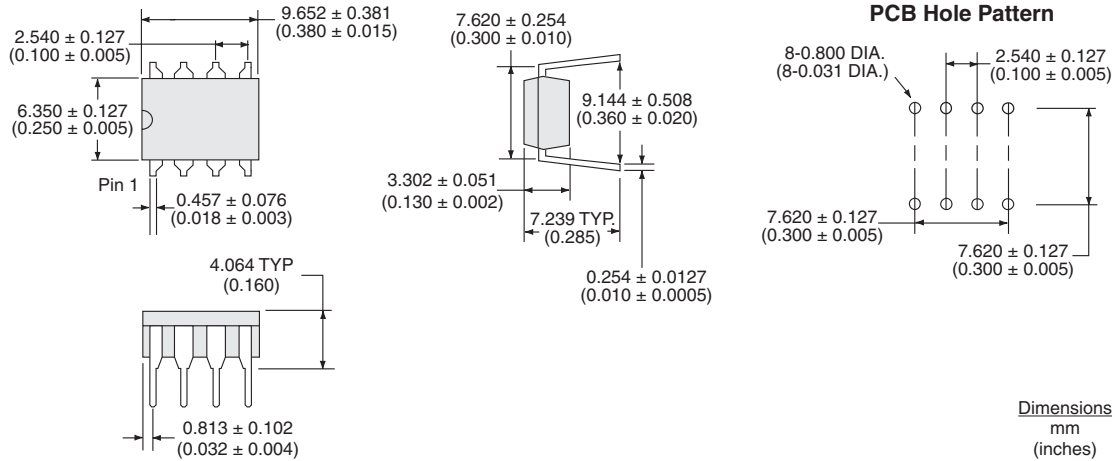

LBA716S

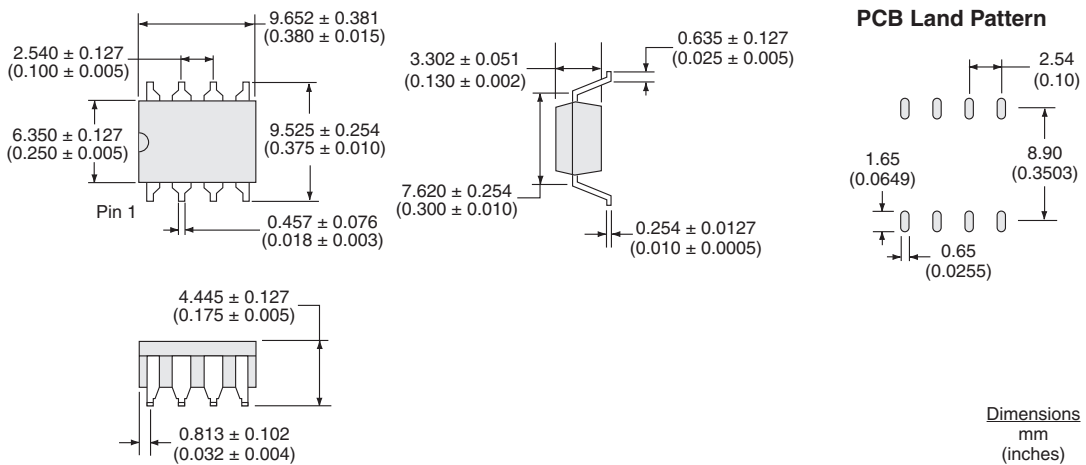

LBA716STR Tape & Reel

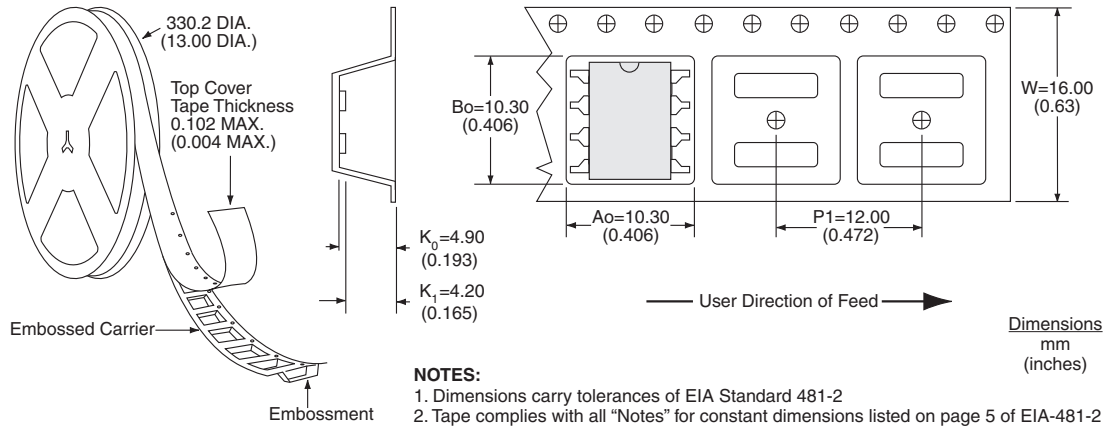

For additional information please visit our website at: www.ixysic.com

IXYS Integrated Circuits makes no representations or warranties with respect to the accuracy or completeness of the contents of this publication and reserves the right to make changes to specifications and product descriptions at any time without notice. Neither circuit patent licenses nor indemnity are expressed or implied. Except as set forth in IXYS Integrated Circuits' Standard Terms and Conditions of Sale, IXYS Integrated Circuits assumes no liability whatsoever, and disclaims any express or implied warranty, relating to its products including, but not limited to, the implied warranty of merchantability, fitness for a particular purpose, or infringement of any intellectual property right.

The products described in this document are not designed, intended, authorized or warranted for use as components in systems intended for surgical implant into the body, or in other applications intended to support or sustain life, or where malfunction of IXYS Integrated Circuits' product may result in direct physical harm, injury, or death to a person or severe property or environmental damage. IXYS Integrated Circuits reserves the right to discontinue or make changes to its products at any time without notice.

Specification: DS-LBA716-R04
 ©Copyright 2018, IXYS Integrated Circuits
 OptoMOS[®] is a registered trademark of IXYS Integrated Circuits
 All rights reserved. Printed in USA.
 6/25/2018

单击下面可查看定价，库存，交付和生命周期等信息

[>>Littelfuse\(美国力特\)](#)