

SP1007 Series 5pF 8kV Bidirectional Discrete TVS

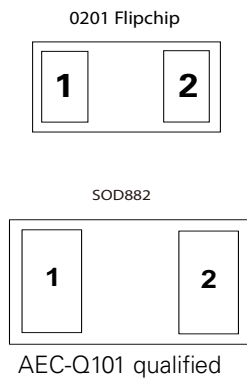

Pinout



Description

The SP1007 diodes are fabricated in a proprietary back-to-back silicon avalanche technology. These diodes provide a high ESD (electrostatic discharge) protection level for electronic equipment. The SP1007 TVS can safely absorb repetitive ESD strikes at the maximum level specified in IEC 61000-4-2 international standard (Level 4, ±8kV contact discharge) without performance degradation. The back-to-back configuration provides symmetrical ESD protection for data lines when AC signals are present.

Features

- ESD, IEC 61000-4-2, ±8kV contact, ±15kV air
- EFT, IEC 61000-4-4, 40A (5/50ns)
- Lightning, 2A (8/20 as defined in IEC 61000-4-5 2nd edition)
- Low capacitance of 5pF (TYP @ $V_R = 5V$)
- Low leakage current of 0.1µA at 5V
- Space efficient 0201 and 0402 footprint
- AEC-Q101 qualified for SOD882 package
- Moisture Sensitivity Level (MSL -1) for SOD882 package
- Halogen free, lead free and RoHS compliant

Applications

- Mobile Phones
- Smart Phones
- Camcorders
- Portable Medical
- Digital Cameras
- MP3/PMP
- Portable Navigation Components
- Tablets
- Point of Sale Terminals

Functional Block Diagram

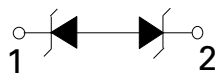

Application Example

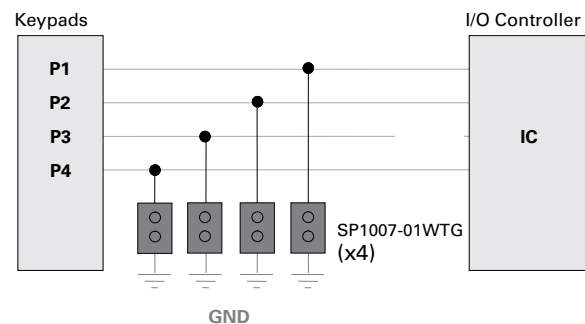

Life Support Note:

Not Intended for Use in Life Support or Life Saving Applications

The products shown herein are not designed for use in life sustaining or life saving applications unless otherwise expressly indicated.

Absolute Maximum Ratings

Symbol	Parameter	Value	Units
I_{PP}	Peak Current ($t_p=8/20\mu s$)	2.0	A
T_{OP}	Operating Temperature	-40 to 125	°C
T_{STOR}	Storage Temperature	-55 to 150	°C

CAUTION: Stresses above those listed in "Absolute Maximum Ratings" may cause permanent damage to the component. This is a stress only rating and operation of the component at these or any other conditions above those indicated in the operational sections of this specification is not implied.

Electrical Characteristics ($T_{OP}=25^\circ C$)

Parameter	Symbol	Test Conditions	Min	Typ	Max	Units
Reverse Standoff Voltage	V_{RWM}	$I_R = 1\mu A$	-	-	6.0	V
Breakdown Voltage	V_{BR}	$I_R = 1mA$	-	8.5	9.5	V
Reverse Leakage Current	I_{LEAK}	$V_R = 5V$	-	0.1	0.5	μA
Dynamic Resistance ²	R_{DYN}	TLP, $t_p = 100ns$, I/O to GND	-	0.8	-	Ω
Clamp Voltage ¹	V_C	$I_{pp}=1A, t_p=8/20\mu s$, Fwd	-	10	50	V
		$I_{pp}=2A, t_p=8/20\mu s$, Fwd		12		
ESD Withstand Voltage ¹	V_{ESD}	IEC 61000-4-2 (Contact Discharge)	± 8	-	-	kV
		IEC 61000-4-2 (Air Discharge)	± 15	-	-	kV
Diode Capacitance ¹	C_{VO-VO}	Reverse Bias=0V f =1MHZ	-	5	6	pF

Note:

- Parameter is guaranteed by design and/or component characterization.
- Transmission Line Pulse (TLP) with 100ns width, 2ns rise time, and average window $t_1=70ns$ to $t_2=90ns$

Capacitance vs. Reverse Bias

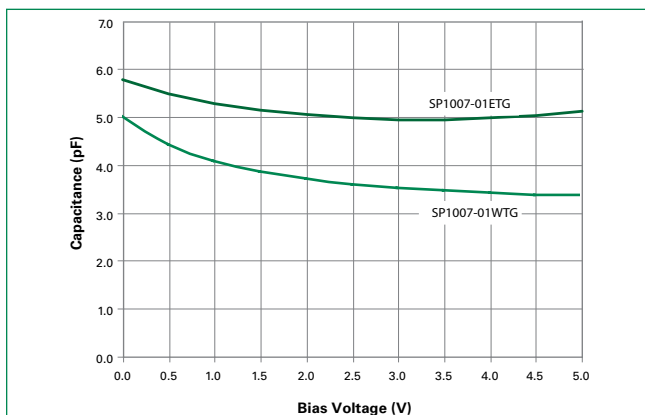

8/20 μs Pulse Waveform

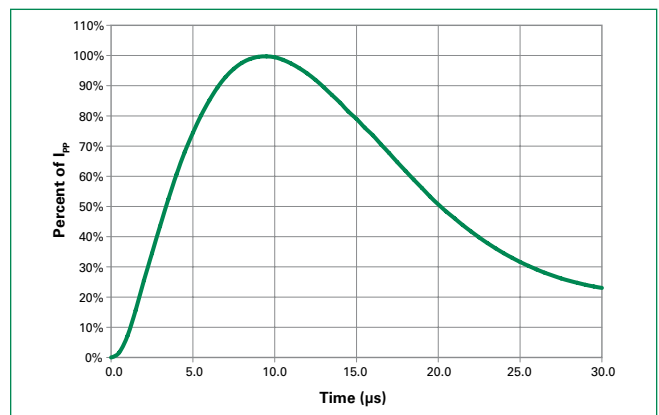

Insertion Loss (S21) I/O to GND

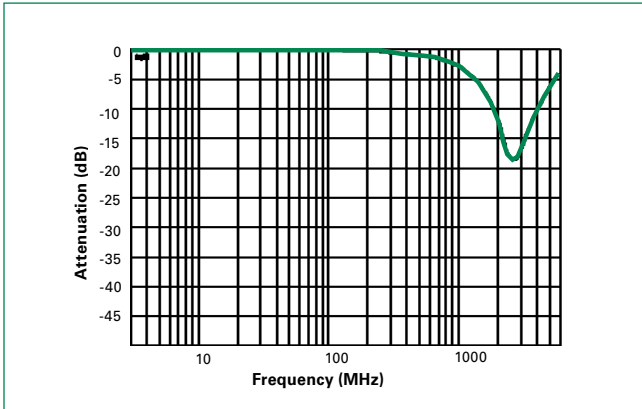

Transmission Line Pulsing(TLP) Plot

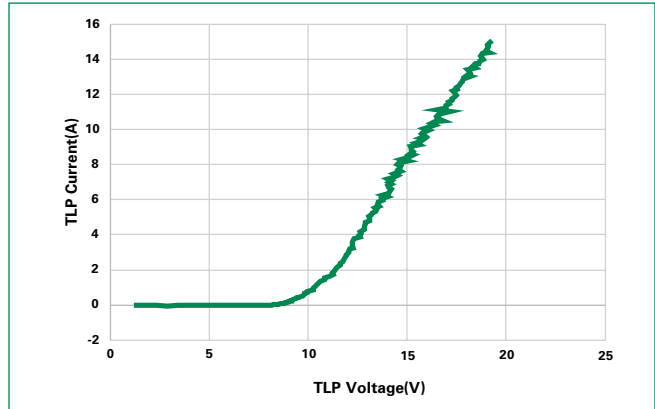

Product Characteristics of SOD-882 Package

Lead Plating	Pre-Plated Frame
Lead Material	Copper Alloy
Substrate material	Silicon
Body Material	Molded Compound
Flammability	UL Recognized compound meeting flammability rating V-0

Soldering Parameters

Reflow Condition	Pb – Free assembly	
Pre Heat	- Temperature Min ($T_{s(min)}$)	150°C
	- Temperature Max ($T_{s(max)}$)	200°C
	- Time (min to max) (t_s)	60 – 180 secs
Average ramp up rate (Liquidus) Temp (T_L) to peak		3°C/second max
$T_{s(max)}$ to T_L - Ramp-up Rate		3°C/second max
Reflow	- Temperature (T_L) (Liquidus)	217°C
	- Temperature (t_L)	60 – 150 seconds
Peak Temperature (T_p)		260 ^{+0/-5} °C
Time within 5°C of actual peak Temperature (t_p)		20 – 40 seconds
Ramp-down Rate		6°C/second max
Time 25°C to peak Temperature (T_p)		8 minutes Max.
Do not exceed		260°C

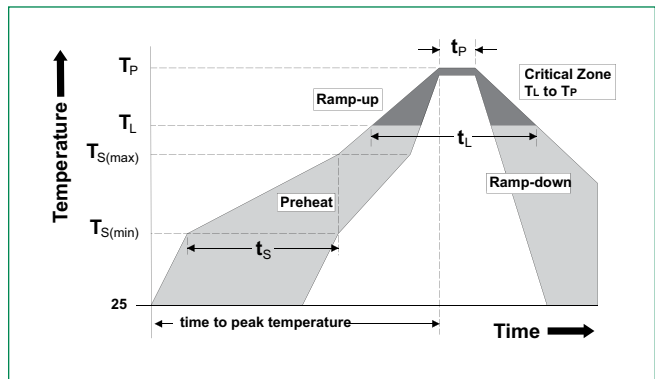

Part Numbering System

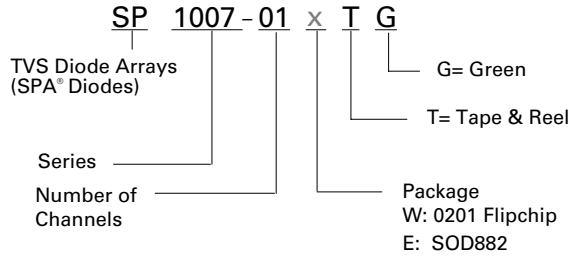

Ordering Information

Part Number	Package	Min. Order Qty.
SP1007-01WTG	0201 Flipchip	10000
SP1007-01ETG	SOD882	10000

Part Marking System



Package Dimensions — 0201 Flip Chip

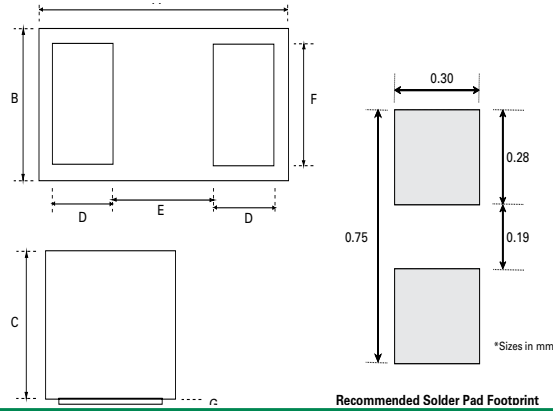

Symbol	0201 Flipchip					
	Millimeters			Inches		
	Min	Typ	Max	Min	Typ	Max
A	0.595	0.620	0.645	0.0234	0.0244	0.0254
B	0.295	0.320	0.345	0.0116	0.0126	0.0136
C	0.245	0.275	0.305	0.0096	0.0108	0.0120
D	0.145	0.150	0.155	0.0057	0.0059	0.0061
E	0.245	0.250	0.255	0.0096	0.0098	0.0100
F	0.245	0.250	0.255	0.0096	0.0098	0.0100
G	0.005	0.010	0.015	0.0002	0.0004	0.0006

Package Dimensions — SOD882

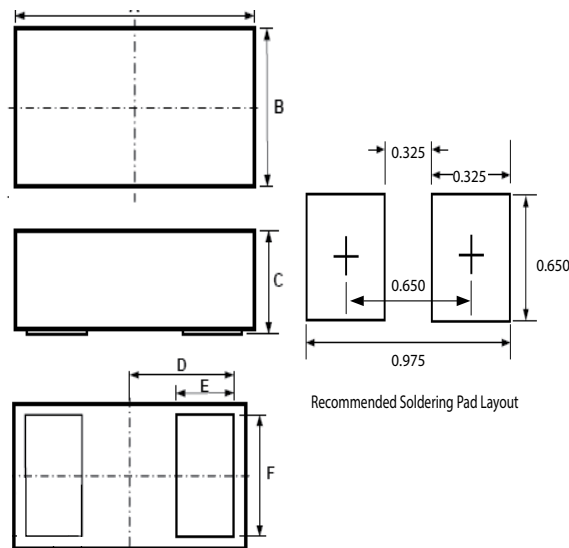

Symbol	Package	SOD882					
	JEDEC	MO-236					
		Millimeters			Inches		
		Min	Typ	Max	Min	Typ	Max
A		0.95	1.00	1.05	0.037	0.039	0.041
B		0.55	0.60	0.65	0.022	0.024	0.026
C		0.50	0.55	0.60	0.020	0.022	0.024
D			0.45			0.018	
E		0.20	0.25	0.30	0.008	0.010	0.012
F		0.45	0.50	0.55	0.018	0.020	0.022

Embossed Carrier Tape & Reel Specification – 0201 Flipchip

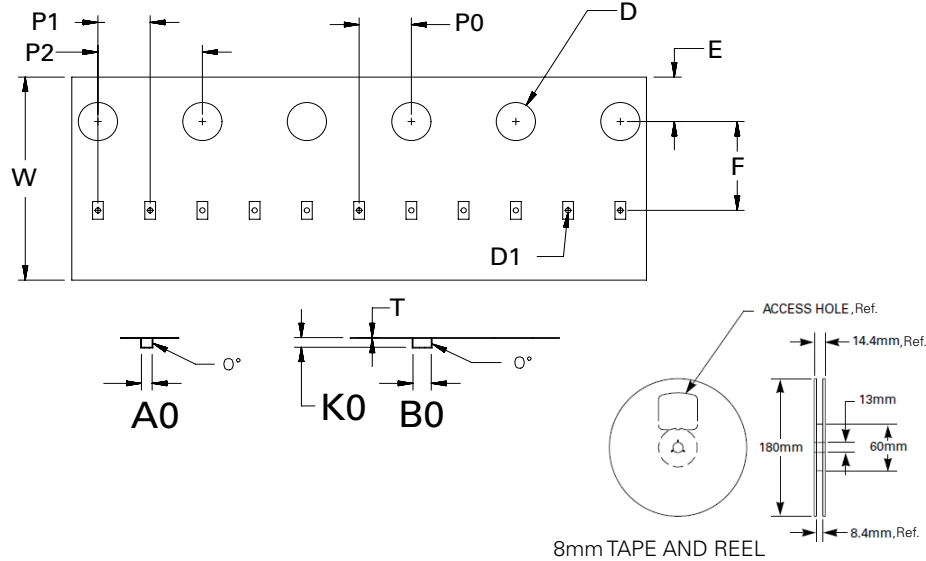

Symbol	Millimeters
A0	0.41+/-0.03
B0	0.70+/-0.03
D	ø 1.50 + 0.10
D1	ø 0.20 +/- 0.05
E	1.75+/-0.10
F	3.50+/-0.05
K0	0.38+/-0.03
P0	2.00+/-0.05
P1	2.00+/-0.05
P2	4.00+/-0.10
W	8.00 + 0.30 -0.10
T	0.23+/-0.02

Embossed Carrier Tape & Reel Specification – SOD882

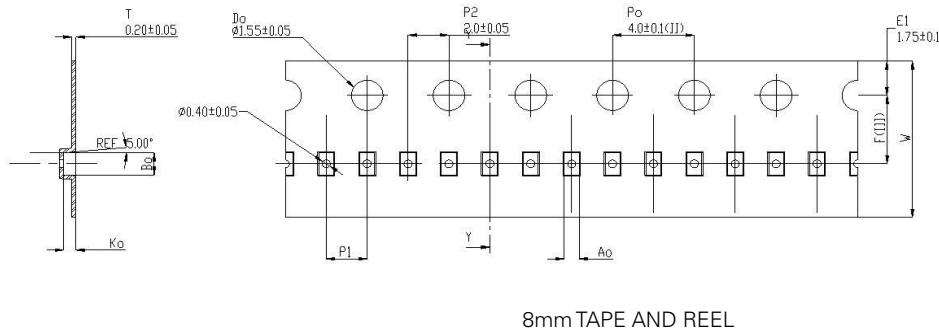

Symbol	Millimeters
A0	0.70+/-0.045
B0	1.10+/-0.045
K0	0.65+/-0.045
F	3.50+/-0.05
P1	2.00+/-0.10
W	8.00 + 0.30 -0.10

Disclaimer Notice - Information furnished is believed to be accurate and reliable. However, users should independently evaluate the suitability of and test each product selected for their own applications. Littelfuse products are not designed for, and may not be used in, all applications. Read complete Disclaimer Notice at <http://www.littelfuse.com/disclaimer-electronics>.

单击下面可查看定价，库存，交付和生命周期等信息

[>>Littelfuse\(美国力特\)](#)