

MC Series - DO-214



Agency Approvals

| Agency | Agency File Number |
|---|--------------------|
|  | E133083 |

Pinout Designation

NOT APPLICABLE

Schematic Symbol



Description

The MC Series DO-214 are low capacitance SIDACtor® components designed to protect broadband equipment such as VOIP, DSL modems and DSLAMs from damaging overvoltage transients.

The series provides a surface mount solution that enables equipment to comply with global regulatory standards while limiting the impact to broadband signals.

Features and Benefits

- Low voltage overshoot
- Low on-state voltage
- Does not degrade surge capability after multiple surge events within limit.
- 40% lower capacitance than our Baseband Protectors, for applications that demand greater signal integrity
- RoHS Compliant and Halogen-Free
- Pb-free E3 means 2nd level interconnect is Pb-free and the terminal finish material is tin(Sn) (IPC/JEDEC J-STD-609A.01)
- Fails short circuit when surged in excess of ratings

Applicable Global Standards

- TIA-968-A
- TIA-968-B
- ITU K.20/21/45 Enhanced Level*
- ITU K.20/21/45 Basic Level
- GR 1089 Inter-building*
- GR 1089 Intra-building
- IEC 61000-4-5 2nd edition
- YD/T 1082
- YD/T 993
- YD/T 950

*A-rated parts require series resistance

Electrical Characteristics

| Part Number | Marking | V_{DRM} @ $I_{DRM}=5\mu A$ | V_S @ 100V/ μs | I_H | I_S | I_T | V_T @ $I_T=2.2$ Amps | Capacitance @ 1MHz, 2V bias | |
|--------------|---------|---------------------------------|--------------------------|--------|--------|-------|---------------------------|--------------------------------|--------|
| | | V min | V max | mA min | mA max | A max | V max | pF min | pF max |
| P0080SAMCLRP | P-8AM | 6 | 25 | 50 | 800 | 2.2 | 4 | 10 | 35 |
| P0220SAMCLRP | P02AM | 15 | 32 | 50 | 800 | 2.2 | 4 | 10 | 35 |
| P0300SAMCLRP | P03AM | 25 | 40 | 50 | 800 | 2.2 | 4 | 10 | 35 |
| P0080SCMCLRP | P-8CM | 6 | 25 | 50 | 800 | 2.2 | 4 | 25 | 60 |
| P0220SCMCLRP | P02CM | 15 | 32 | 50 | 800 | 2.2 | 4 | 25 | 60 |
| P0300SCMCLRP | P03CM | 25 | 40 | 50 | 800 | 2.2 | 4 | 15 | 40 |
| P0640SCMCLRP | P06CM | 58 | 77 | 150 | 800 | 2.2 | 4 | 50 | 80 |
| P0720SCMCLRP | P07CM | 65 | 88 | 150 | 800 | 2.2 | 4 | 50 | 75 |
| P0900SCMCLRP | P09CM | 75 | 98 | 150 | 800 | 2.2 | 4 | 40 | 70 |
| P1100SCMCLRP | P11CM | 90 | 130 | 150 | 800 | 2.2 | 4 | 40 | 70 |
| P1300SCMCLRP | P13CM | 120 | 160 | 150 | 800 | 2.2 | 4 | 35 | 60 |
| P1500SCMCLRP | P15CM | 140 | 180 | 150 | 800 | 2.2 | 4 | 30 | 55 |
| P1800SCMCLRP | P18CM | 170 | 220 | 150 | 800 | 2.2 | 4 | 30 | 50 |
| P2100SCMCLRP | P21CM | 180 | 240 | 150 | 800 | 2.2 | 4 | 30 | 50 |
| P2300SCMCLRP | P23CM | 190 | 260 | 150 | 800 | 2.2 | 4 | 30 | 50 |
| P2600SCMCLRP | P26CM | 220 | 300 | 150 | 800 | 2.2 | 4 | 30 | 45 |
| P3100SCMCLRP | P31CM | 275 | 350 | 150 | 800 | 2.2 | 4 | 30 | 45 |
| P3500SCMCLRP | P35CM | 320 | 400 | 150 | 800 | 2.2 | 4 | 25 | 50 |
| P4500SCMCLRP | P45CM | 400 | 530 | 50 | 800 | 2.2 | 4 | 25 | 45 |

Notes:

- Absolute maximum ratings measured at $T_A=25^\circ C$ (unless otherwise noted).

- Components are bi-directional.

© 2017 Littelfuse, Inc.

Specifications are subject to change without notice.

Revised: 02/23/17

Surge Ratings

| Series | I_{PP} | | | | | | | | | | I_{TSM} 50/60 Hz | di/dt |
|--------|----------------------|-------------------|---------------------|---------------------|---------------------|--------------------|---------------------|----------------------|---------------------|---------------------|-----------------------|----------|
| | 0.2/310 ¹ | 2/10 ¹ | 8/20 ¹ | 10/160 ¹ | 10/560 ¹ | 5/320 ¹ | 10/360 ¹ | 10/1000 ¹ | 5/310 ¹ | 10/700 ¹ | | |
| | 0.5/700 ² | 2/10 ² | 1.2/50 ² | 10/160 ² | 10/560 ² | 9/720 ² | 10/360 ² | 10/1000 ² | 10/700 ² | 10/700 ² | | |
| | A min | A min | A min | A min | A min | A min | A min | A min | A min | A min | A min | A/μs max |
| A | 20 | 150 | 150 | 90 | 50 | 75 | 75 | 45 | 75 | 25 | 500 | |
| C | 50 | 500 | 400 | 200 | 150 | 200 | 175 | 100 | 200 ³ | 35 | 500 | |

Notes:
 1 Current waveform in μs
 2 Voltage waveform in μs
 3 For surge rating of P4500SCMCLRP 10/700μs min=150A

- Peak pulse current rating (I_{pp}) is repetitive and guaranteed for the life of the product that remains in thermal equilibrium.
 - I_{pp} ratings applicable over temperature range of -40°C to +85°C
 - The component must initially be in thermal equilibrium with -40°C ≤ T_J ≤ +150°C

Thermal Considerations

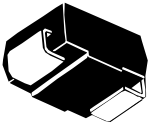
| Package | Symbol | Parameter | Value | Unit |
|---|-----------|---|-------------|------|
| DO-214AA  | T_J | Operating Junction Temperature Range | -40 to +150 | °C |
| | T_S | Storage Temperature Range | -65 to +150 | °C |
| | $R_{θJA}$ | Thermal Resistance: Junction to Ambient | 90 | °C/W |

V-I Characteristics

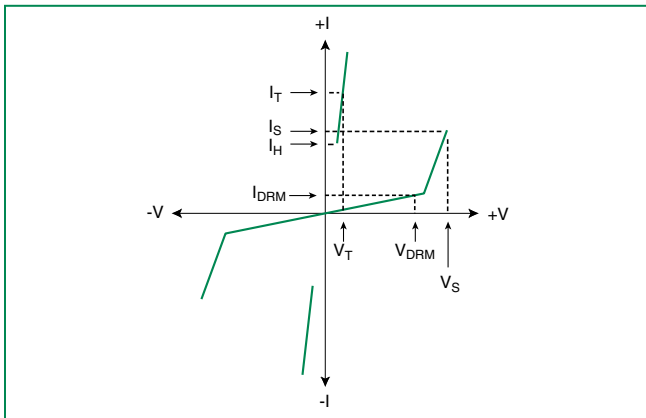

$t_r \times t_d$ Pulse Waveform

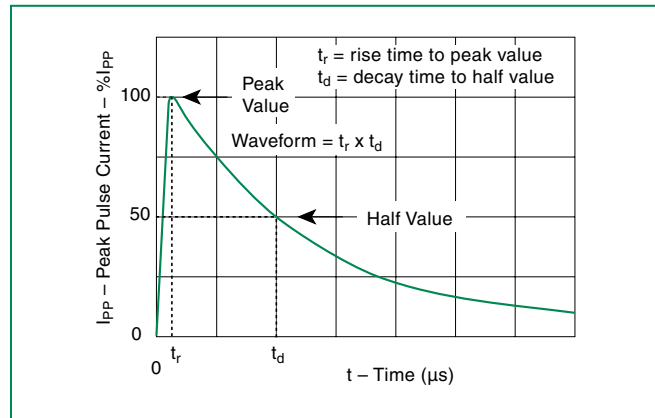

Normalized V_S Change vs. Junction Temperature

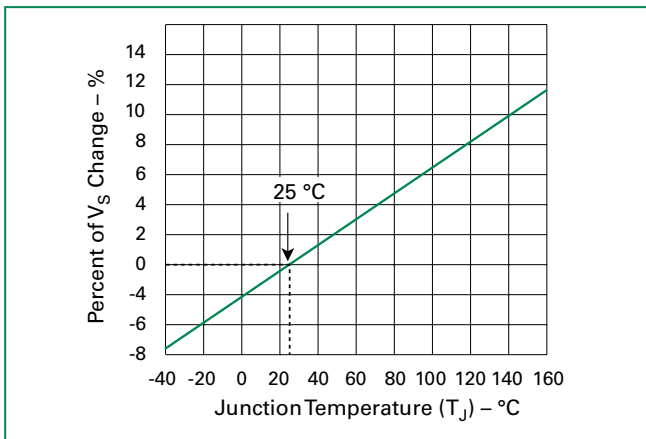

Normalized DC Holding Current vs. Case Temperature

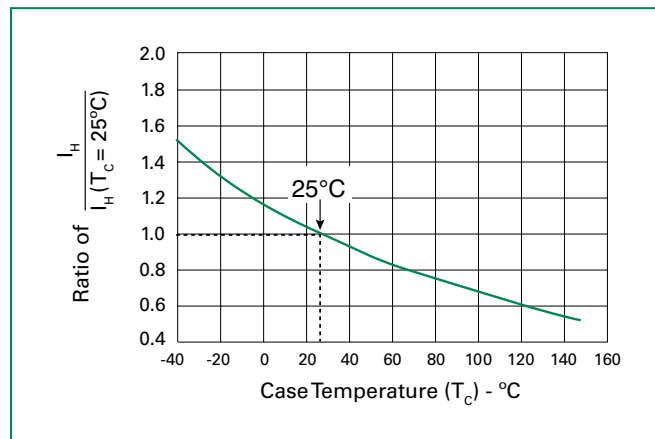

Soldering Parameters

| | | |
|--|-----------------------------------|--------------|
| Reflow Condition | Pb-Free assembly (see Fig. 1) | |
| Pre Heat | -Temperature Min ($T_{s(min)}$) | +150°C |
| | -Temperature Max ($T_{s(max)}$) | +200°C |
| | -Time (Min to Max) (t_s) | 60-180 secs. |
| Average ramp up rate (Liquidus Temp (T_L) to peak) | 3°C/sec. Max. | |
| $T_{s(max)}$ to T_L - Ramp-up Rate | 3°C/sec. Max. | |
| Reflow | -Temperature (T_L) (Liquidus) | +217°C |
| | -Temperature (t_L) | 60-150 secs. |
| Peak Temp (T_p) | +260(+0/-5)°C | |
| Time within 5°C of actual PeakTemp (t_p) | 30 secs. Max. | |
| Ramp-down Rate | 6°C/sec. Max. | |
| Time 25°C to Peak Temp (T_p) | 8 min. Max. | |
| Do not exceed | +260°C | |

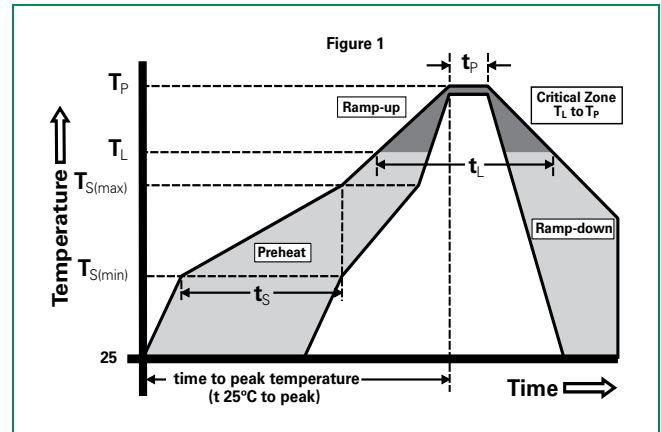

Physical Specifications

| | |
|-----------------|---|
| Lead Material | Copper Alloy |
| Terminal Finish | 100% Matte-Tin Plated |
| Body Material | UL Recognized epoxy meeting flammability classification V-0 |

Environmental Specifications

| | |
|----------------------------------|--|
| High Temp Voltage Blocking | 80% Rated V_{DRM} ($V_{AC Peak}$) +125°C or +150°C, 504 or 1008 hrs. MIL-STD-750 (Method 1040) JEDEC, JESD22-A-101 |
| Temp Cycling | -65°C to +150°C, 15 min. dwell, 10 up to 100 cycles. MIL-STD-750 (Method 1051) EIA/JEDEC, JESD22-A104 |
| Biased Temp & Humidity | 52 V_{DC} (+85°C) 85%RH, 504 up to 1008 hrs. EIA/JEDEC, JESD22-A-101 |
| High Temp Storage | +150°C 1008 hrs. MIL-STD-750 (Method 1031) JEDEC, JESD22-A-101 |
| Low Temp Storage | -65°C, 1008 hrs. |
| Thermal Shock | 0°C to +100°C, 5 min. dwell, 10 sec. transfer, 10 cycles. MIL-STD-750 (Method 1056) JEDEC, JESD22-A-106 |
| Autoclave (Pressure Cooker Test) | +121°C, 100%RH, 2atm, 24 up to 168 hrs. EIA/JEDEC, JESD22-A-102 |
| Resistance to Solder Heat | +260°C, 30 secs. MIL-STD-750 (Method 2031) |
| Moisture Sensitivity Level | 85%RH, +85°C, 168 hrs., 3 reflow cycles (+260°C Peak). JEDEC-J-STD-020, Level 1 |

Additional Information



Datasheet



Resources



Samples

Dimensions – DO-214AA

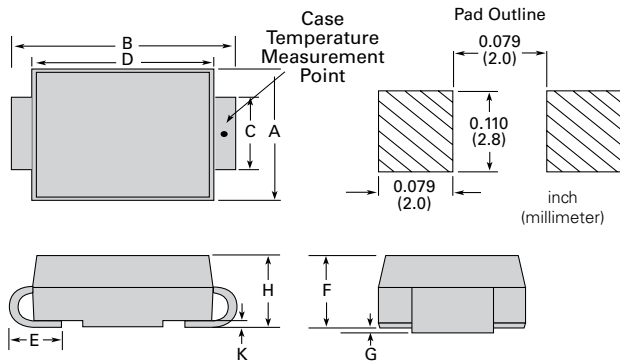

| Dimensions | Inches | | Millimeters | |
|------------|--------|-------|-------------|------|
| | Min | Max | Min | Max |
| A | 0.130 | 0.156 | 3.30 | 3.95 |
| B | 0.201 | 0.220 | 5.10 | 5.60 |
| C | 0.077 | 0.087 | 1.95 | 2.20 |
| D | 0.159 | 0.181 | 4.05 | 4.60 |
| E | 0.030 | 0.063 | 0.75 | 1.60 |
| F | 0.075 | 0.096 | 1.90 | 2.45 |
| G | 0.002 | 0.008 | 0.05 | 0.20 |
| H | 0.077 | 0.104 | 1.95 | 2.65 |
| K | 0.006 | 0.016 | 0.15 | 0.41 |

Part Numbering

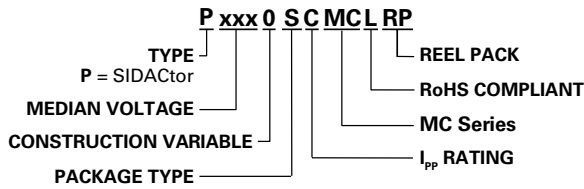

Part Marking

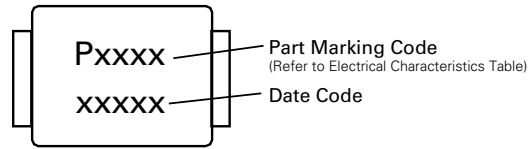

Packing Options

| Package Type | Description | Quantity | Added Suffix | Industry Standard |
|--------------|------------------------------|----------|--------------|-------------------|
| S | DO-214AA Tape & Reel Pack | 2500 | N/A | EIA-481-D |

Tape and Reel Specification – DO-214AA

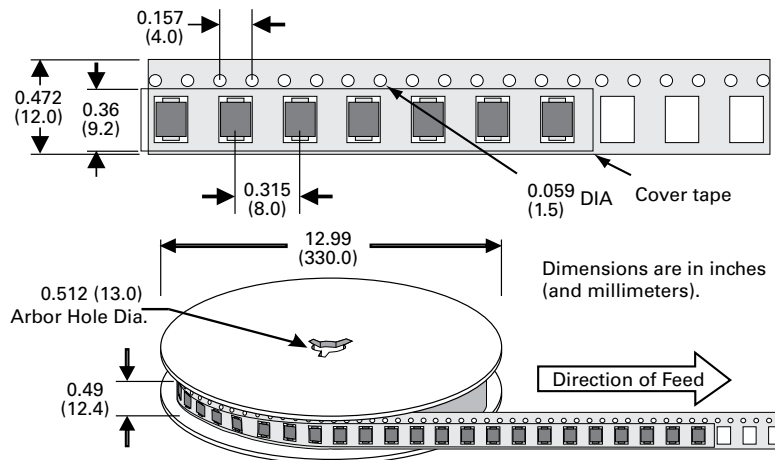

Disclaimer Notice - Information furnished is believed to be accurate and reliable. However, users should independently evaluate the suitability of and test each product selected for their own applications. Littelfuse products are not designed for, and may not be used in, all applications. Read complete Disclaimer Notice at www.littelfuse.com/disclaimer-electronics.

单击下面可查看定价，库存，交付和生命周期等信息

[>>Littelfuse\(美国力特\)](#)