

1200V XPT™ GenX3™ IGBTs

IXYA20N120C3HV IXYP20N120C3 IXYH20N120C3

High-Speed IGBT
for 20-50 kHz Switching

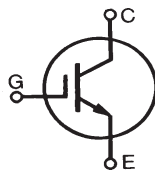

$V_{CES} = 1200V$
 $I_{C110} = 20A$
 $V_{CE(sat)} \leq 3.4V$
 $t_{fi(typ)} = 108ns$

Symbol	Test Conditions	Maximum Ratings	
V_{CES}	$T_J = 25^\circ C$ to $175^\circ C$	1200	V
V_{CGR}	$T_J = 25^\circ C$ to $175^\circ C$, $R_{GE} = 1M\Omega$	1200	V
V_{GES}	Continuous	± 20	V
V_{GEM}	Transient	± 30	V
I_{C25}	$T_C = 25^\circ C$	40	A
I_{C110}	$T_C = 110^\circ C$	20	A
I_{CM}	$T_C = 25^\circ C$, 1ms	96	A
I_A	$T_C = 25^\circ C$	10	A
E_{AS}	$T_C = 25^\circ C$	400	mJ
SSOA (RBSOA)	$V_{GE} = 15V$, $T_{VJ} = 150^\circ C$, $R_G = 10\Omega$ Clamped Inductive Load	$I_{CM} = 40$ @ $V_{CE} \leq V_{CES}$	A
P_C	$T_C = 25^\circ C$	278	W
T_J		-55 ... +175	$^\circ C$
T_{JM}		175	$^\circ C$
T_{stg}		-55 ... +175	$^\circ C$
T_L	Maximum Lead Temperature for Soldering	300	$^\circ C$
T_{SOLD}	1.6 mm (0.062in.) from Case for 10s	260	$^\circ C$
M_d	Mounting Torque (TO-220 & TO247)	1.13/10	Nm/lb.in.
F_c	Mounting Force (TO-263)	10..65 / 22..14.6	N/lb
Weight	TO-263	2.5	g
	TO-220	3.0	g
	TO-247	6.0	g

TO-263HV (IXYA)

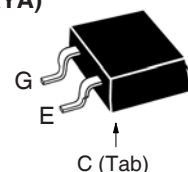

TO-220 (IXYP)

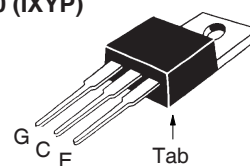

TO-247 AD (IXYH)

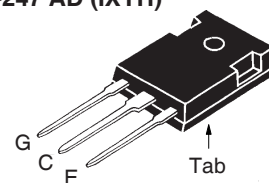

G = Gate C = Collector
E = Emitter Tab = Collector

Features

- High Voltage Package
- Optimized for Low Switching Losses
- Square RBSOA
- Positive Thermal Coefficient of $V_{ce(sat)}$
- Avalanche Rated
- International Standard Packages

Advantages

- High Power Density
- Low Gate Drive Requirement

Applications

- High Frequency Power Inverters
- UPS
- Motor Drives
- SMPS
- PFC Circuits
- Battery Chargers
- Welding Machines
- Lamp Ballasts

Symbol	Test Conditions ($T_J = 25^\circ C$, Unless Otherwise Specified)	Characteristic Values		
		Min.	Typ.	Max.
BV_{CES}	$I_C = 250\mu A$, $V_{GE} = 0V$	1200		V
$V_{GE(th)}$	$I_C = 250\mu A$, $V_{CE} = V_{GE}$	3.0		5.0 V
I_{CES}	$V_{CE} = V_{CES}$, $V_{GE} = 0V$ $T_J = 150^\circ C$			15 μA 500 μA
I_{GES}	$V_{CE} = 0V$, $V_{GE} = \pm 20V$			± 100 nA
$V_{CE(sat)}$	$I_C = 20A$, $V_{GE} = 15V$, Note 1 $T_J = 150^\circ C$		4.0	3.4 V V

Symbol Test Conditions ($T_J = 25^\circ\text{C}$ Unless Otherwise Specified)		Characteristic Values		
		Min.	Typ.	Max.
g_{fs}	$I_C = 20\text{A}, V_{CE} = 10\text{V}, \text{Note 1}$	7.0	11.5	S
C_{ies}	$V_{CE} = 25\text{V}, V_{GE} = 0\text{V}, f = 1\text{MHz}$		1110	pF
C_{oes}			70	pF
C_{res}			27	pF
$Q_{g(on)}$	$I_C = 20\text{A}, V_{GE} = 15\text{V}, V_{CE} = 0.5 \cdot V_{CES}$		53	nC
Q_{ge}			9	nC
Q_{gc}			22	nC
$t_{d(on)}$	Inductive load, $T_J = 25^\circ\text{C}$ $I_C = 20\text{A}, V_{GE} = 15\text{V}$ $V_{CE} = 0.5 \cdot V_{CES}, R_G = 10\Omega$ Note 2		20	ns
t_{ri}			29	ns
E_{on}			1.3	mJ
$t_{d(off)}$			90	ns
t_{fi}			108	ns
E_{off}			0.5	1.0
$t_{d(on)}$	Inductive load, $T_J = 150^\circ\text{C}$ $I_C = 20\text{A}, V_{GE} = 15\text{V}$ $V_{CE} = 0.5 \cdot V_{CES}, R_G = 10\Omega$ Note 2		20	ns
t_{ri}			40	ns
E_{on}			3.7	mJ
$t_{d(off)}$			115	ns
t_{fi}			105	ns
E_{off}			0.7	mJ
R_{thJC}				0.54 $^\circ\text{C/W}$
R_{thCS}	TO-220		0.50	$^\circ\text{C/W}$
R_{thCS}	TO-247		0.21	$^\circ\text{C/W}$

Notes:

1. Pulse test, $t \leq 300\mu\text{s}$, duty cycle, $d \leq 2\%$.
2. Switching times & energy losses may increase for higher $V_{CE}(\text{clamp})$, T_J or R_G .

TO-220 Outline

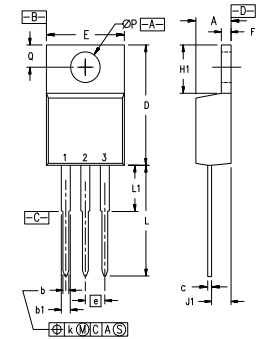

Pins: 1 - Gate 2 - Collector
3 - Emitter

SYM	INCHES		MILLIMETERS	
	MIN	MAX	MIN	MAX
A	.170	.190	4.32	4.83
b	.025	.040	0.64	1.02
b1	.045	.065	1.15	1.65
c	.014	.022	0.35	0.56
D	.580	.630	14.73	16.00
E	.390	.420	9.91	10.66
e	.100 BSC		2.54 BSC	
F	.045	.055	1.14	1.40
H1	.230	.270	5.85	6.85
J1	.090	.110	2.29	2.79
k	0	.015	0	0.38
L	.500	.550	12.70	13.97
L1	.110	.230	2.79	5.84
ØP	.139	.161	3.53	4.08
Q	.100	.125	2.54	3.18

TO-247 Outline

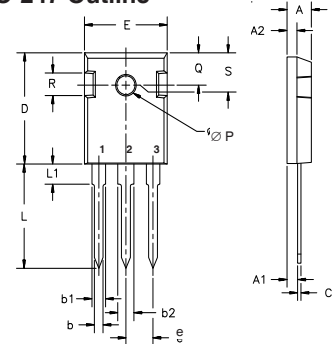

Terminals: 1 - Gate 2 - Collector
3 - Emitter

Dim.	Millimeter		Inches	
	Min.	Max.	Min.	Max.
A	4.7	5.3	.185	.209
A ₁	2.2	2.54	.087	.102
A ₂	2.2	2.6	.059	.098
b	1.0	1.4	.040	.055
b ₁	1.65	2.13	.065	.084
b ₂	2.87	3.12	.113	.123
C	.4	.8	.016	.031
D	20.80	21.46	.819	.845
E	15.75	16.26	.610	.640
e	5.20	5.72	0.205	0.225
L	19.81	20.32	.780	.800
L1		4.50		.177
ØP	3.55	3.65	.140	.144
Q	5.89	6.40	0.232	0.252
R	4.32	5.49	.170	.216
S	6.15	BSC	242	BSC

TO-263HV Outline

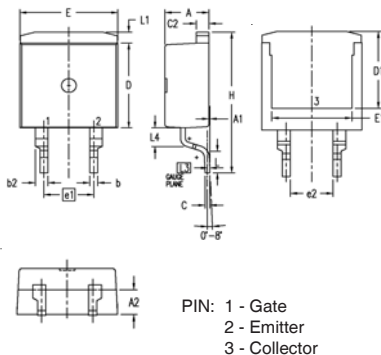

PIN: 1 - Gate
2 - Emitter
3 - Collector

SYM	INCHES		MILLIMETER	
	MIN	MAX	MIN	MAX
A	.170	.185	4.30	4.70
A1	.000	.008	0.00	0.20
A2	.091	.098	2.30	2.50
b	.028	.035	0.70	0.90
b2	.046	.054	1.18	1.38
C	.018	.024	0.45	0.60
C2	.049	.055	1.25	1.40
D	.354	.370	9.00	9.40
D1	.311	.327	7.90	8.30
E	.386	.402	9.80	10.20
E1	.307	.323	7.80	8.20
e1	.200 BSC		5.08 BSC	
(e2)	.163	.174	4.13	4.43
H	.591	.614	15.00	15.60
L	.079	.102	2.00	2.60
L1	.039	.055	1.00	1.40
L3	.010 BSC		0.254 BSC	
(L4)	.071	.087	1.80	2.20

IXYS Reserves the Right to Change Limits, Test Conditions, and Dimensions.

IXYS MOSFETs and IGBTs are covered by one or more of the following U.S. patents:	4,835,592	4,931,844	5,049,961	5,237,481	6,162,665	6,404,065 B1	6,683,344	6,727,585	7,005,734 B2	7,157,338B2
	4,860,072	5,017,508	5,063,307	5,381,025	6,259,123 B1	6,534,343	6,710,405 B2	6,759,692	7,063,975 B2	
	4,881,106	5,034,796	5,187,117	5,486,715	6,306,728 B1	6,583,505	6,710,463	6,771,478 B2	7,071,537	

Fig. 1. Output Characteristics @ $T_J = 25^\circ\text{C}$

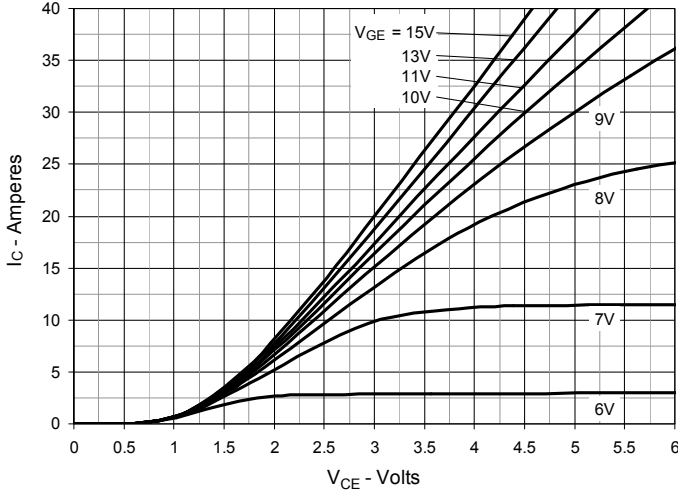

Fig. 2. Extended Output Characteristics @ $T_J = 25^\circ\text{C}$

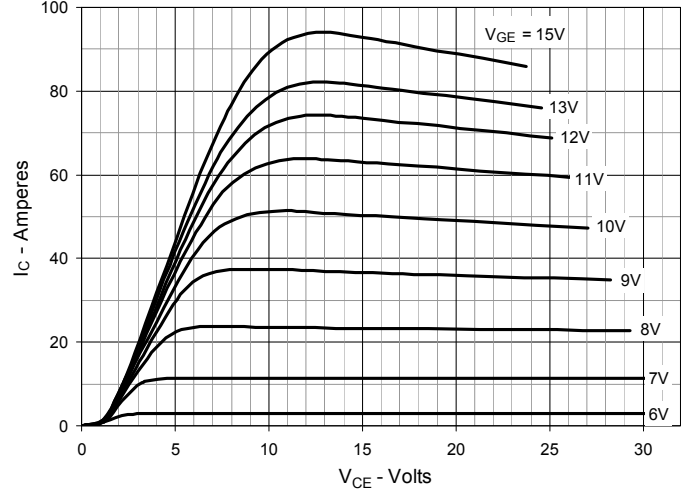

Fig. 3. Output Characteristics @ $T_J = 150^\circ\text{C}$

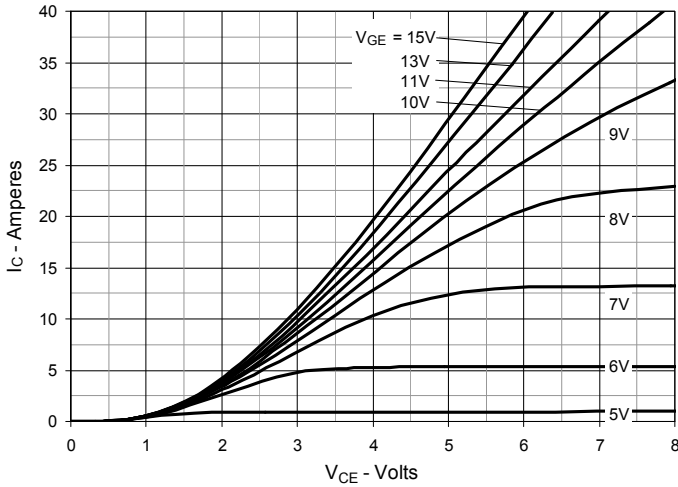

Fig. 4. Dependence of $V_{CE(sat)}$ on Junction Temperature

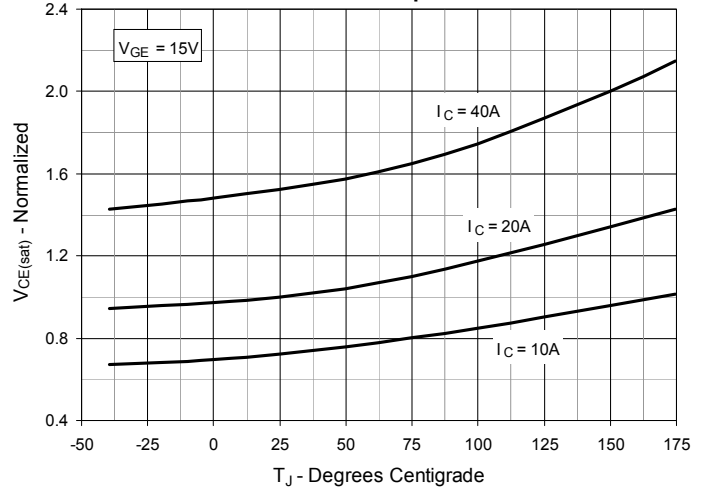

Fig. 5. Collector-to-Emitter Voltage vs. Gate-to-Emitter Voltage

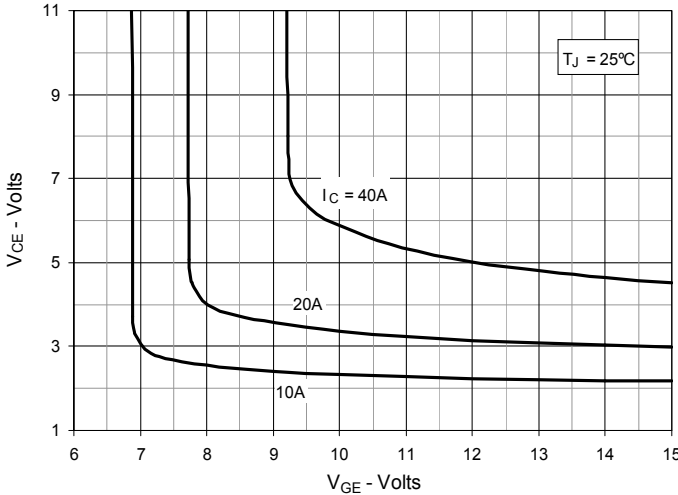

Fig. 6. Input Admittance

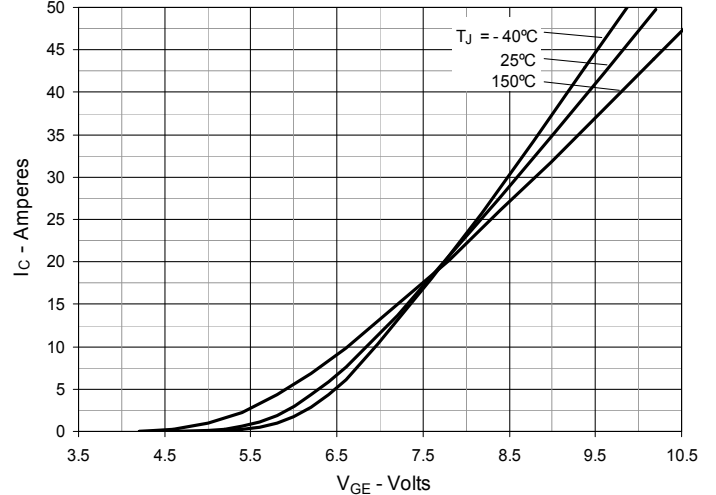

Fig. 7. Transconductance

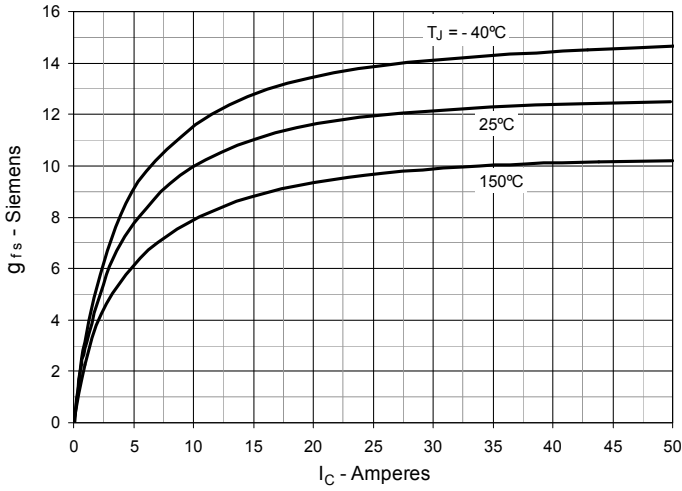

Fig. 8. Gate Charge

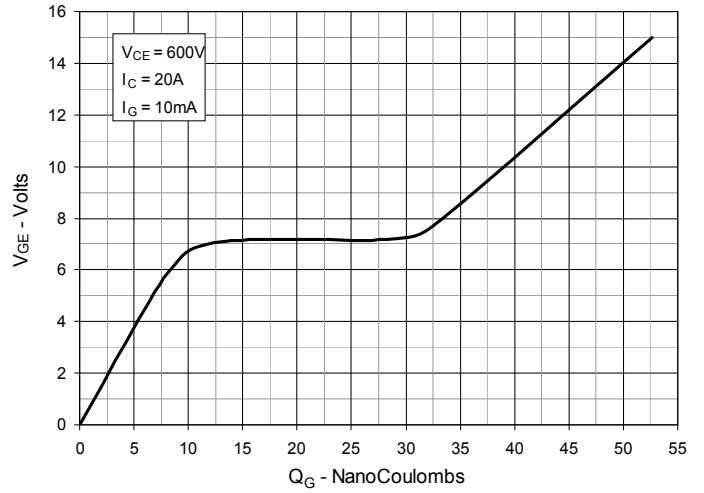

Fig. 9. Capacitance

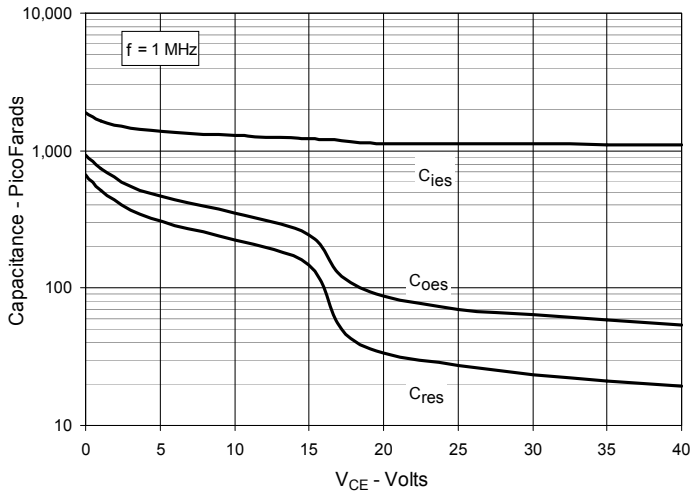

Fig. 10. Reverse-Bias Safe Operating Area

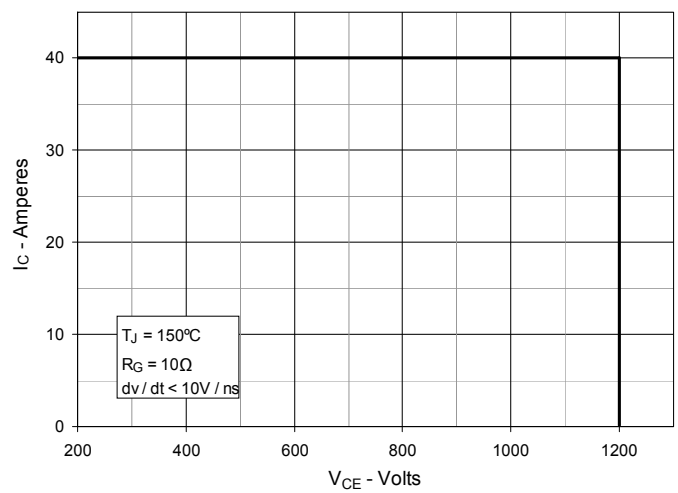

Fig. 11. Maximum Transient Thermal Impedance

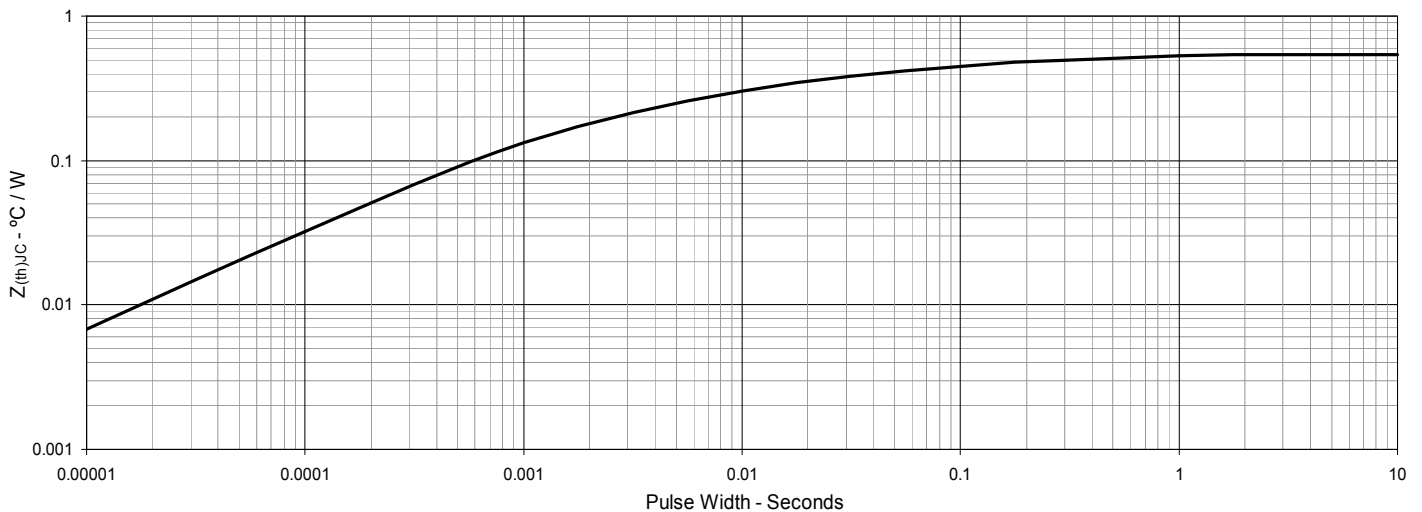

Fig. 12. Inductive Switching Energy Loss vs. Gate Resistance

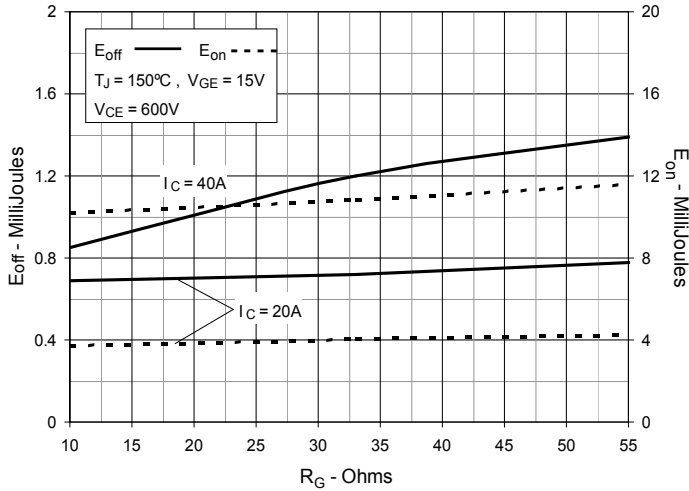

Fig. 13. Inductive Switching Energy Loss vs. Collector Current



Fig. 14. Inductive Switching Energy Loss vs. Junction Temperature

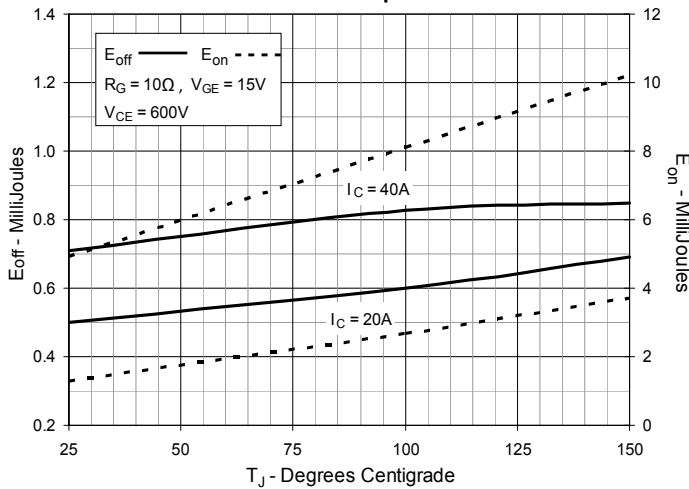

Fig. 15. Inductive Turn-off Switching Times vs. Gate Resistance

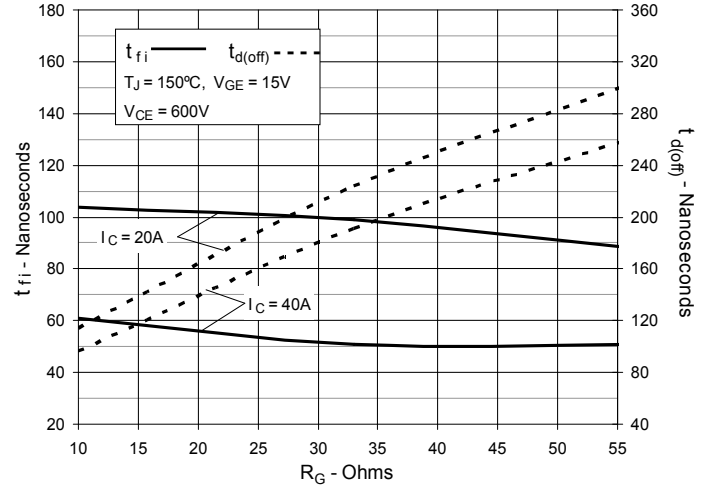

Fig. 16. Inductive Turn-off Switching Times vs. Collector Current

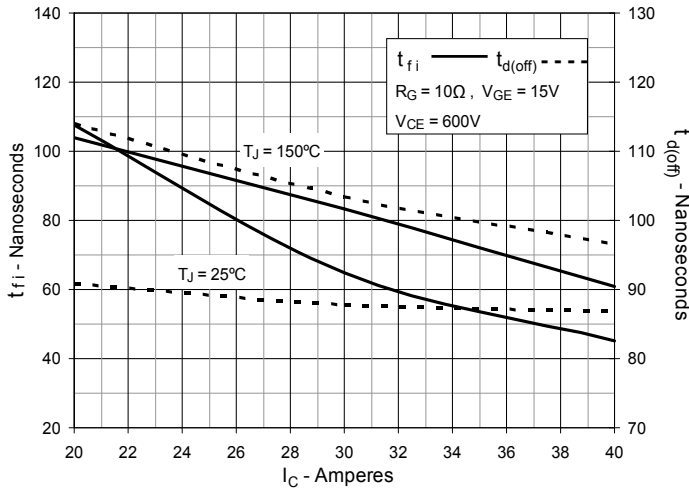

Fig. 17. Inductive Turn-off Switching Times vs. Junction Temperature

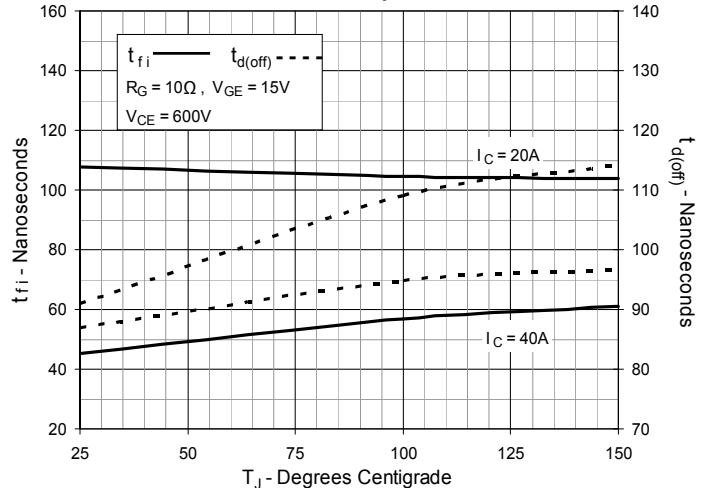

Fig. 18. Inductive Turn-on Switching Times vs. Gate Resistance

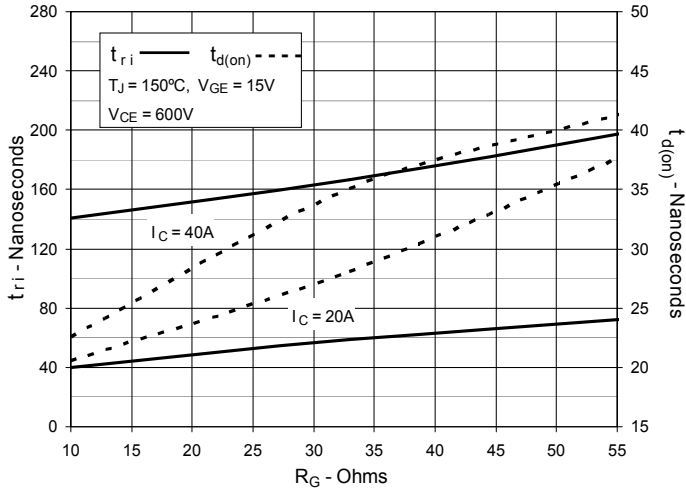

Fig. 19. Inductive Turn-on Switching Times vs. Collector Current

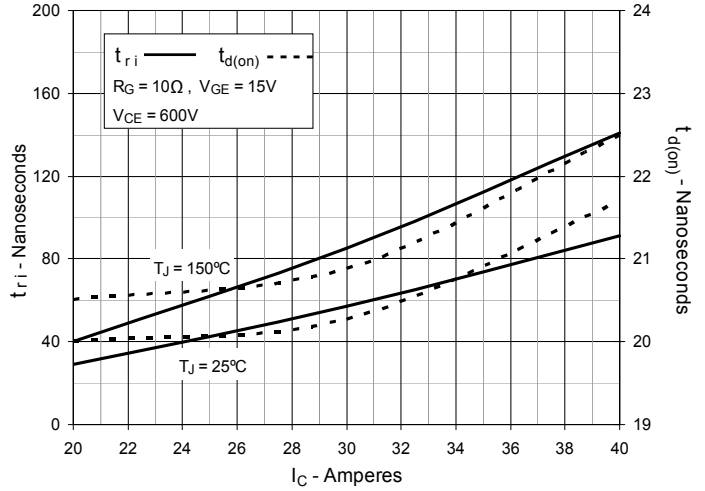

Fig. 20. Inductive Turn-on Switching Times vs. Junction Temperature

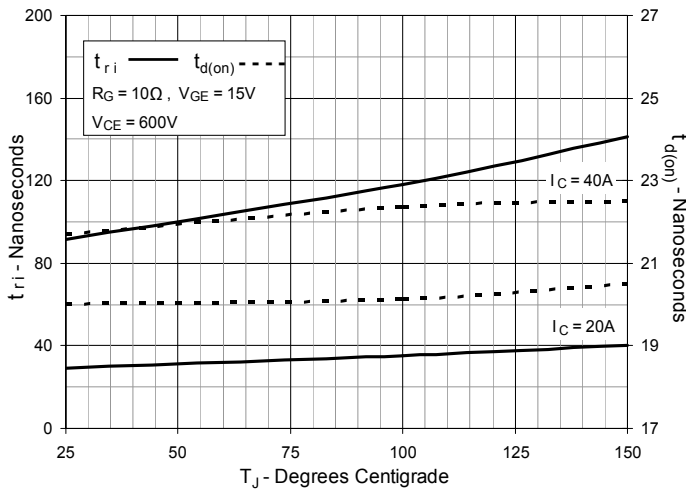
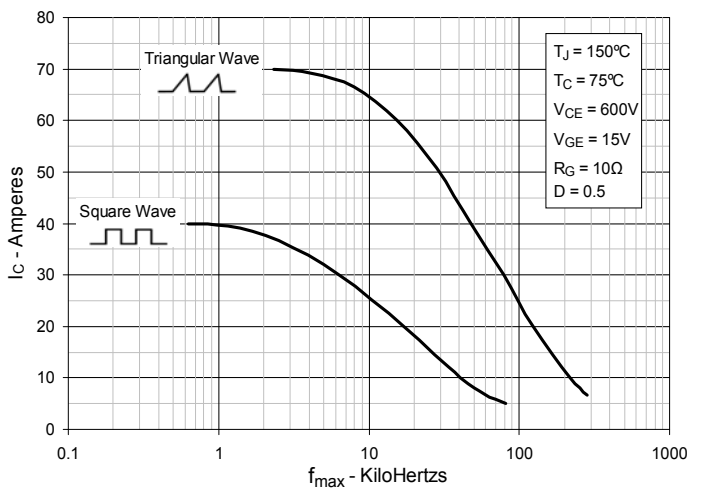

Fig. 21. Maximum Peak Load Current vs. Frequency





Disclaimer Notice - Information furnished is believed to be accurate and reliable. However, users should independently evaluate the suitability of and test each product selected for their own applications. Littelfuse products are not designed for, and may not be used in, all applications. Read complete Disclaimer Notice at www.littelfuse.com/disclaimer-electronics.

单击下面可查看定价，库存，交付和生命周期等信息

[>>Littelfuse\(美国力特\)](#)