

# SPHV-C Series

## 200W Discrete Bidirectional TVS Diode

**HF** **RoHS** **Pb**

### Additional Information

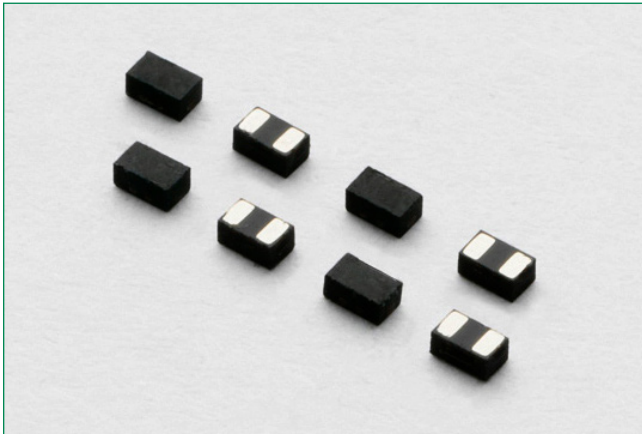

Resources



Accessories



Samples

### Pinout

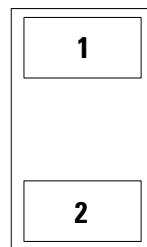

### Description

The Bidirectional SPHV-C series is designed for use in portable applications, LED lighting modules, automotive applications, and low speed I/Os. It will protect sensitive equipment from damage due to electrostatic discharge (ESD) and other overvoltage transients.

The SPHV-C series can safely absorb repetitive ESD strikes above the maximum level of the IEC 61000-4-2 international standard (Level 4,  $\pm 8\text{kV}$  contact discharge) without performance degradation and safely dissipate up to 8A (SPHV12-C) of induced surge current (IEC 61000-4-5, 2nd Edition  $t_P=8/20\mu\text{s}$ ) with very low clamping voltages.

### Features & Benefits

- ESD, IEC 61000-4-2,  $\pm 30\text{kV}$  contact,  $\pm 30\text{kV}$  air
- EFT, IEC 61000-4-4, 40A (5/50ns)
- Lightning, IEC 61000-4-5 2nd Edition, 8A ( $t_P=8/20\mu\text{s}$ , SPHV12-C)
- Low clamping voltage
- Low leakage current
- Small SOD882 packaging helps save board space
- AEC-Q101 Qualified
- Halogen free, Lead free and RoHS compliant
- Moisture Sensitivity Level(MSL -1)

### Applications

- LED Lighting Modules
- Portable Instrumentation
- General Purpose I/O
- Mobile & Handhelds
- RS232 / RS485
- CAN and LIN Bus

### Functional Block Diagram

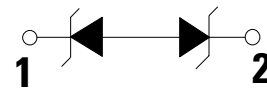

Life Support Note:

**Not Intended for Use in Life Support or Life Saving Applications**

The products shown herein are not designed for use in life sustaining or life saving applications unless otherwise expressly indicated.

# SPHV-C Series

## 200W Discrete Bidirectional TVS Diode

### Absolute Maximum Ratings

Symbol	Parameter	Value	Units
$P_{pk}$	Peak Pulse Power ( $t_p=8/20\mu s$ )	200	W
$T_{OP}$	Operating Temperature	-40 to 125	°C
$T_{STOR}$	Storage Temperature	-55 to 150	°C

**CAUTION:** Stresses above those listed in "Absolute Maximum Ratings" may cause permanent damage to the device. This is a stress only rating and operation of the device at these or any other conditions above those indicated in the operational sections of this specification is not implied.

### SPHV12-C Electrical Characteristics ( $T_{OP}=25^\circ C$ )

Parameter	Symbol	Test Conditions	Min	Typ	Max	Units
Reverse Standoff Voltage	$V_{RWM}$	$I_R \leq 1\mu A$			12.0	V
Breakdown Voltage	$V_{BR}$	$I_R = 1mA$	13.3			V
Reverse Leakage Current	$I_{LEAK}$	$V_R = 12V$			1.0	$\mu A$
Clamp Voltage <sup>1</sup>	$V_C$	$I_{PP} = 1A, t_p = 8/20\mu s, Fwd$			19.0	V
		$I_{PP} = 8A, t_p = 8/20\mu s, Fwd$			25.0	V
Dynamic Resistance <sup>2</sup>	$R_{DYN}$	TLP, $t_p = 100ns, I/O$ to GND		0.48		$\Omega$
Peak Pulse Current	$I_{PP}$	$t_p = 8/20\mu s$			8.0	A
ESD Withstand Voltage <sup>1</sup>	$V_{ESD}$	IEC61000-4-2 (Contact Discharge)	$\pm 30$			kV
		IEC61000-4-2 (Air Discharge)	$\pm 30$			kV
Diode Capacitance <sup>1</sup>	$C_{I/O-I/O}$	Reverse Bias=0V, $f=1MHz$			30	pF

**Note:**

1. Parameter is guaranteed by design and/or device characterization.
2. Transmission Line Pulse (TLP) with 100ns width and 200ps rise time.

### SPHV15-C Electrical Characteristics ( $T_{OP}=25^\circ C$ )

Parameter	Symbol	Test Conditions	Min	Typ	Max	Units
Reverse Standoff Voltage	$V_{RWM}$	$I_R \leq 1\mu A$			15.0	V
Breakdown Voltage	$V_{BR}$	$I_R = 1mA$	16.7			V
Reverse Leakage Current	$I_{LEAK}$	$V_R = 15V$			1.0	$\mu A$
Clamp Voltage <sup>1</sup>	$V_C$	$I_{PP} = 1A, t_p = 8/20\mu s, Fwd$			22.0	V
		$I_{PP} = 5A, t_p = 8/20\mu s, Fwd$			30.0	V
Dynamic Resistance <sup>2</sup>	$R_{DYN}$	TLP, $t_p = 100ns, I/O$ to GND		0.43		$\Omega$
Peak Pulse Current	$I_{PP}$	$t_p = 8/20\mu s$			5.0	A
ESD Withstand Voltage <sup>1</sup>	$V_{ESD}$	IEC61000-4-2 (Contact Discharge)	$\pm 30$			kV
		IEC61000-4-2 (Air Discharge)	$\pm 30$			kV
Diode Capacitance <sup>1</sup>	$C_{I/O-I/O}$	Reverse Bias=0V, $f=1MHz$			24	pF

**Note:**

1. Parameter is guaranteed by design and/or device characterization.
2. Transmission Line Pulse (TLP) with 100ns width and 200ps rise time.

# SPHV-C Series

## 200W Discrete Bidirectional TVS Diode

### SPHV24-C Electrical Characteristics ( $T_{OP}=25^{\circ}\text{C}$ )

Parameter	Symbol	Test Conditions	Min	Typ	Max	Units
Reverse Standoff Voltage	$V_{RWM}$	$I_R \leq 1\mu\text{A}$			24.0	V
Breakdown Voltage	$V_{BR}$	$I_R = 1\text{mA}$	26.7			V
Reverse Leakage Current	$I_{LEAK}$	$V_R = 24\text{V}$			1.0	$\mu\text{A}$
Clamp Voltage <sup>1</sup>	$V_C$	$I_{PP} = 1\text{A}$ , $t_p = 8/20\mu\text{s}$ , Fwd			36.0	V
		$I_{PP} = 3\text{A}$ , $t_p = 8/20\mu\text{s}$ , Fwd			50.0	V
Dynamic Resistance <sup>2</sup>	$R_{DYN}$	TLP, $t_p = 100\text{ns}$ , I/O to GND		0.65		$\Omega$
Peak Pulse Current	$I_{PP}$	$t_p = 8/20\mu\text{s}$			3.0	A
ESD Withstand Voltage <sup>1</sup>	$V_{ESD}$	IEC61000-4-2 (Contact Discharge)	$\pm 24$			kV
		IEC61000-4-2 (Air Discharge)	$\pm 30$			kV
Diode Capacitance <sup>1</sup>	$C_{I/O-I/O}$	Reverse Bias=0V, f=1MHz			17	pF

**Note:**

- Parameter is guaranteed by design and/or device characterization.
- Transmission Line Pulse (TLP) with 100ns width and 200ps rise time.

### SPHV36-C Electrical Characteristics ( $T_{OP}=25^{\circ}\text{C}$ )

Parameter	Symbol	Test Conditions	Min	Typ	Max	Units
Reverse Standoff Voltage	$V_{RWM}$	$I_R \leq 1\mu\text{A}$			36.0	V
Breakdown Voltage	$V_{BR}$	$I_R = 1\text{mA}$	40.0			V
Reverse Leakage Current	$I_{LEAK}$	$V_R = 36\text{V}$			1.0	$\mu\text{A}$
Clamp Voltage <sup>1</sup>	$V_C$	$I_{PP} = 1\text{A}$ , $t_p = 8/20\mu\text{s}$ , Fwd			52.0	V
		$I_{PP} = 2\text{A}$ , $t_p = 8/20\mu\text{s}$ , Fwd			65.0	V
Dynamic Resistance <sup>2</sup>	$R_{DYN}$	TLP, $t_p = 100\text{ns}$ , I/O to GND		1.33		$\Omega$
Peak Pulse Current	$I_{PP}$	$t_p = 8/20\mu\text{s}$			2.0	A
ESD Withstand Voltage <sup>1</sup>	$V_{ESD}$	IEC61000-4-2 (Contact Discharge)	$\pm 15$			kV
		IEC61000-4-2 (Air Discharge)	$\pm 20$			kV
Diode Capacitance <sup>1</sup>	$C_{I/O-I/O}$	Reverse Bias=0V, f=1MHz			13	pF

**Note:**

- Parameter is guaranteed by design and/or device characterization.
- Transmission Line Pulse (TLP) with 100ns width and 200ps rise time.

#### Non-Repetitive Peak Pulse Power vs. Pulse Time

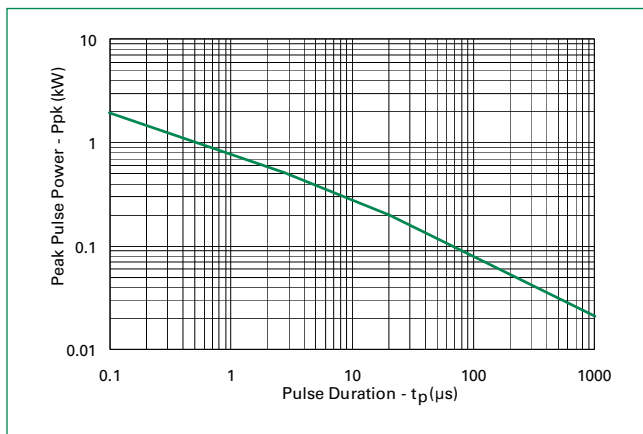

#### Power Derating Curve

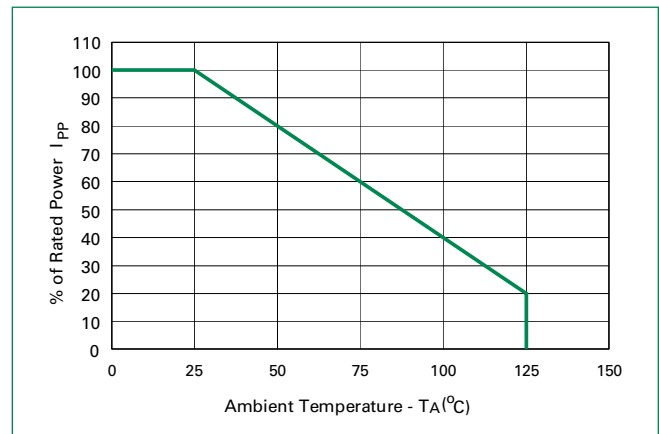

# SPHV-C Series

## 200W Discrete Bidirectional TVS Diode

### 8/20 $\mu$ s Pulse Waveform

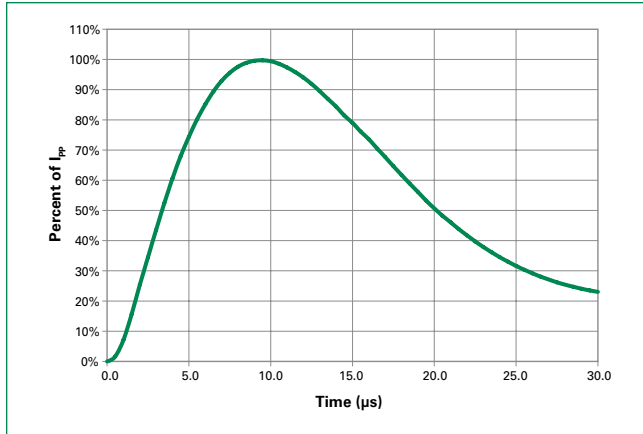

### SPHV12-C Transmission Line Pulsing (TLP) Plot

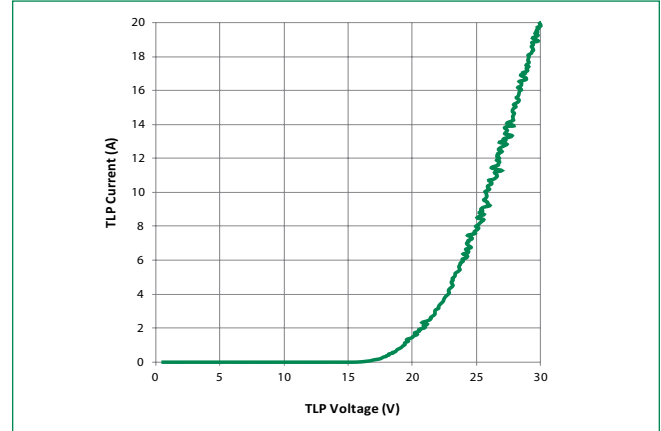

### SPHV15-C Transmission Line Pulsing (TLP) Plot

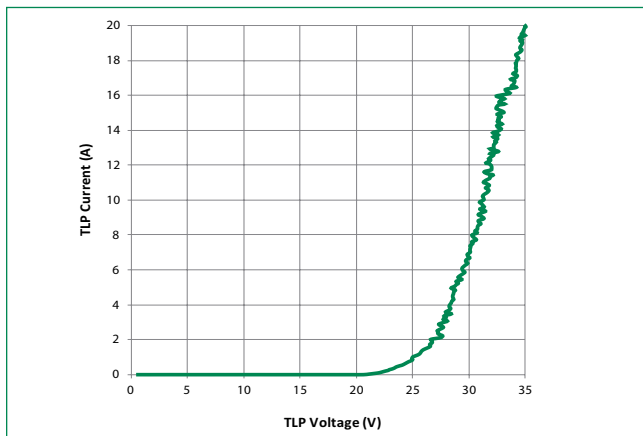

### SPHV24-C Transmission Line Pulsing (TLP) Plot

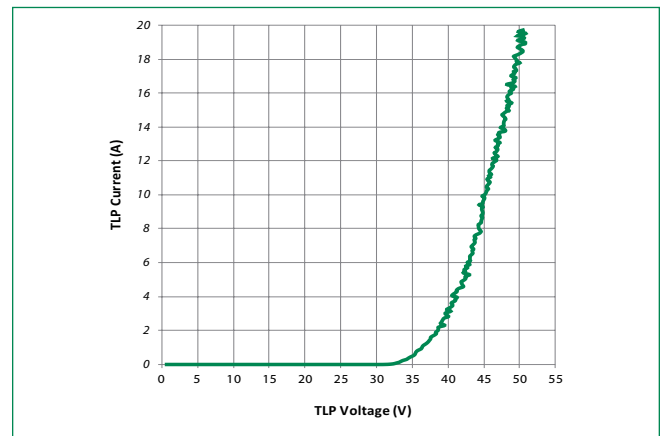

### SPHV36-C Transmission Line Pulsing (TLP) Plot

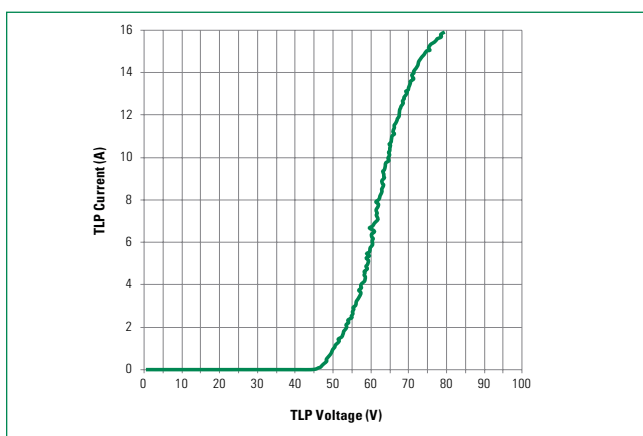

# SPHV-C Series

## 200W Discrete Bidirectional TVS Diode

### Soldering Parameters

<b>Reflow Condition</b>		Pb – Free assembly
<b>Pre Heat</b>	- Temperature Min ( $T_{s(min)}$ )	150°C
	- Temperature Max ( $T_{s(max)}$ )	200°C
	- Time (min to max) ( $t_p$ )	60 – 120 secs
<b>Average ramp up rate (Liquidus) Temp (<math>T_L</math>) to peak</b>		3°C/second max
<b><math>T_{S(max)}</math> to <math>T_L</math> - Ramp-up Rate</b>		3°C/second max
<b>Reflow</b>	- Temperature ( $T_L$ ) (Liquidus)	217°C
	- Temperature ( $t_L$ )	60 – 150 seconds
<b>Peak Temperature (<math>T_p</math>)</b>		260 <sup>+0/-5</sup> °C
<b>Time within 5°C of actual peak Temperature (<math>t_p</math>)</b>		30 seconds
<b>Ramp-down Rate</b>		6°C/second max
<b>Time 25°C to peak Temperature (<math>T_p</math>)</b>		8 minutes Max.
<b>Do not exceed</b>		260°C

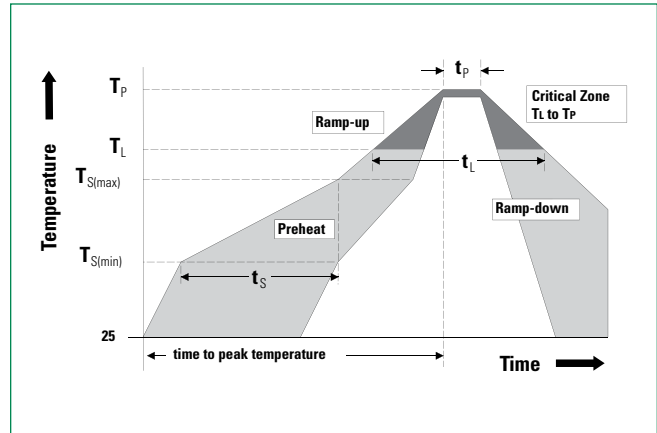

### Product Characteristics

<b>Lead Plating</b>	Matte Tin, Pre-Plated Frame
<b>Lead Material</b>	Copper Alloy
<b>Substitute Material</b>	Silicon
<b>Body Material</b>	Molded Compound
<b>Flammability</b>	UL Recognized compound meeting flammability rating V-0

### Ordering Information

Part Number	Package	Marking	Min. Order Qty.
SPHV12-01ETG-C	SOD882	B2	10000
SPHV15-01ETG-C		B5	
SPHV24-01ETG-C		B4	
SPHV36-01ETG-C		B6	

### Part Marking System

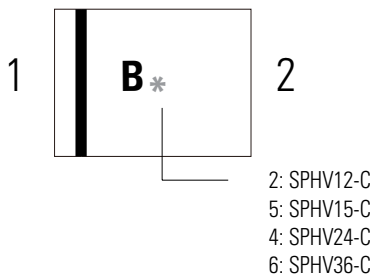

### Part Numbering System

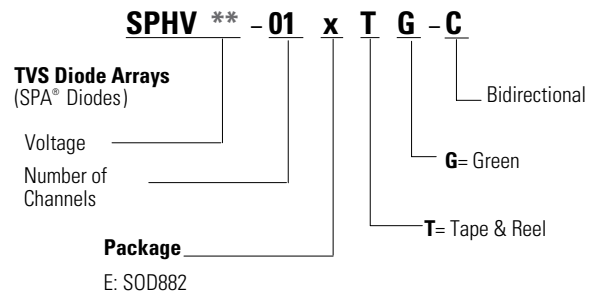

# SPHV-C Series

## 200W Discrete Bidirectional TVS Diode

### Package Dimensions — SOD882(SPHVxx-01ETG-C)

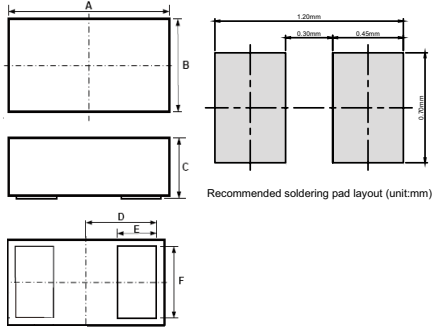

Symbol	Package	SOD882				
	JEDEC	MO-236				
	Millimeters			Inches		
	Min	Typ	Max	Min	Typ	Max
<b>A</b>	0.90	1.00	1.10	0.037	0.039	0.041
<b>B</b>	0.50	0.60	0.70	0.022	0.024	0.026
<b>C</b>	0.40	0.50	0.60	0.016	0.020	0.024
<b>D</b>		0.45			0.018	
<b>E</b>	0.20	0.25	0.35	0.008	0.010	0.012
<b>F</b>	0.45	0.50	0.55	0.018	0.020	0.022

### Embossed Carrier Tape & Reel Specification

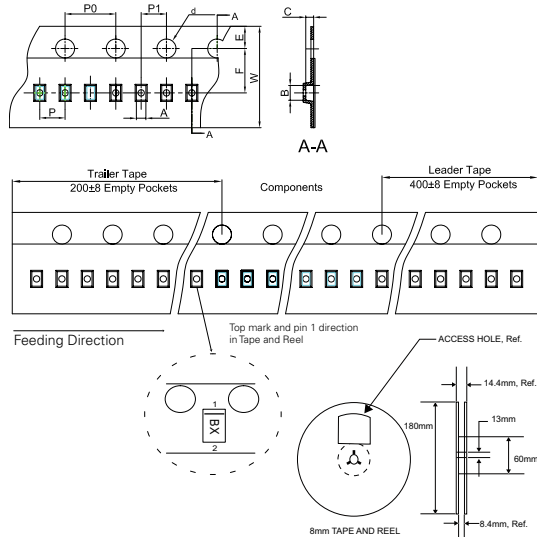

Symbol	Millimeters
<b>A</b>	0.70+/-0.045
<b>B</b>	1.10+/-0.045
<b>C</b>	0.65+/-0.045
<b>d</b>	1.55+/-0.10
<b>E</b>	1.75+/-0.05
<b>F</b>	3.50+/-0.05
<b>P</b>	2.00+/-0.10
<b>P0</b>	4.00+/-0.10
<b>P1</b>	2.00+/-0.10
<b>W</b>	8.00 + 0.30 -0.10

**Disclaimer Notice** - Information furnished is believed to be accurate and reliable. However, users should independently evaluate the suitability of and test each product selected for their own applications. Littelfuse products are not designed for, and may not be used in, all applications. Read complete Disclaimer Notice at <http://www.littelfuse.com/disclaimer-electronics>.

单击下面可查看定价，库存，交付和生命周期等信息

[>>Littelfuse\(美国力特\)](#)