

Standard Rectifier

$$V_{RRM} = 2 \times 1600 \text{ V}$$

$$I_{FAV} = 45 \text{ A}$$

$$V_F = 1.23 \text{ V}$$

Phase leg

Part number

DSP45-16A

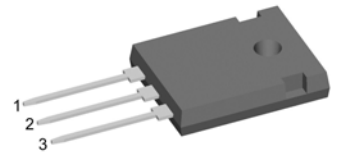

Backside: anode/cathode

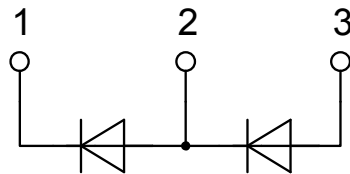

Features / Advantages:

- Planar passivated chips
- Very low leakage current
- Very low forward voltage drop
- Improved thermal behaviour

Applications:

- Diode for main rectification
- For single and three phase bridge configurations

Package: TO-247

- Industry standard outline
- RoHS compliant
- Epoxy meets UL 94V-0

Rectifier			Ratings				
Symbol	Definition	Conditions	min.	typ.	max.	Unit	
V_{RSM}	max. non-repetitive reverse blocking voltage	$T_{VJ} = 25^{\circ}C$			1700	V	
V_{RRM}	max. repetitive reverse blocking voltage	$T_{VJ} = 25^{\circ}C$			1600	V	
I_R	reverse current	$V_R = 1600 V$			40	μA	
		$V_R = 1600 V$			1.5	mA	
V_F	forward voltage drop	$I_F = 45 A$			1.26	V	
		$I_F = 90 A$			1.57	V	
		$I_F = 45 A$	$T_{VJ} = 150^{\circ}C$			1.23	V
		$I_F = 90 A$	$T_{VJ} = 150^{\circ}C$			1.66	V
I_{FAV}	average forward current	$T_C = 130^{\circ}C$ 180° sine			45	A	
V_{FO}	threshold voltage	} for power loss calculation only			0.81	V	
r_F	slope resistance				9.1	m Ω	
R_{thJC}	thermal resistance junction to case				0.55	K/W	
R_{thCH}	thermal resistance case to heatsink		0.25			K/W	
P_{tot}	total power dissipation	$T_C = 25^{\circ}C$			270	W	
I_{FSM}	max. forward surge current	t = 10 ms; (50 Hz), sine	$T_{VJ} = 45^{\circ}C$		480	A	
		t = 8,3 ms; (60 Hz), sine	$V_R = 0 V$		520	A	
		t = 10 ms; (50 Hz), sine	$T_{VJ} = 150^{\circ}C$		410	A	
		t = 8,3 ms; (60 Hz), sine	$V_R = 0 V$		440	A	
I^2t	value for fusing	t = 10 ms; (50 Hz), sine	$T_{VJ} = 45^{\circ}C$		1.15	kA ² s	
		t = 8,3 ms; (60 Hz), sine	$V_R = 0 V$		1.13	kA ² s	
		t = 10 ms; (50 Hz), sine	$T_{VJ} = 150^{\circ}C$		840	A ² s	
		t = 8,3 ms; (60 Hz), sine	$V_R = 0 V$		805	A ² s	
C_J	junction capacitance	$V_R = 400 V$; f = 1 MHz	$T_{VJ} = 25^{\circ}C$	18		pF	

Package TO-247			Ratings			
Symbol	Definition	Conditions	min.	typ.	max.	Unit
I_{RMS}	RMS current	per terminal			70	A
T_{VJ}	virtual junction temperature		-40		175	°C
T_{op}	operation temperature		-40		150	°C
T_{stg}	storage temperature		-40		150	°C
Weight				6		g
M_D	mounting torque		0.8		1.2	Nm
F_C	mounting force with clip		20		120	N

Product Marking

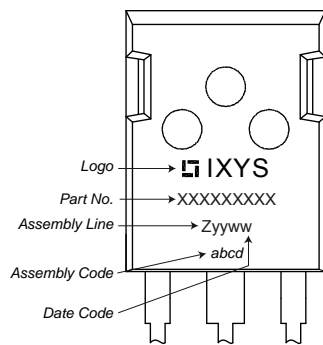

Ordering	Part Number	Marking on Product	Delivery Mode	Quantity	Code No.
Standard	DSP45-16A	DSP45-16A	Tube	30	480665

Similar Part	Package	Voltage class
DSP45-16AZ	TO-268AA (D3Pak) (2HV)	1600
DSP45-16AR	ISOPLUS247 (3)	1600
DSP45-12A	TO-247AD (3)	1200
DSP45-12AZ	TO-268AA (D3Pak) (2HV)	1200
DSP45-18A	TO-247AD (3)	1800

Equivalent Circuits for Simulation

* on die level

$T_{VJ} = 175\text{ °C}$

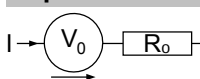

Rectifier

$V_{0\ max}$	threshold voltage	0.81	V
$R_{0\ max}$	slope resistance *	6.5	mΩ

Outlines TO-247

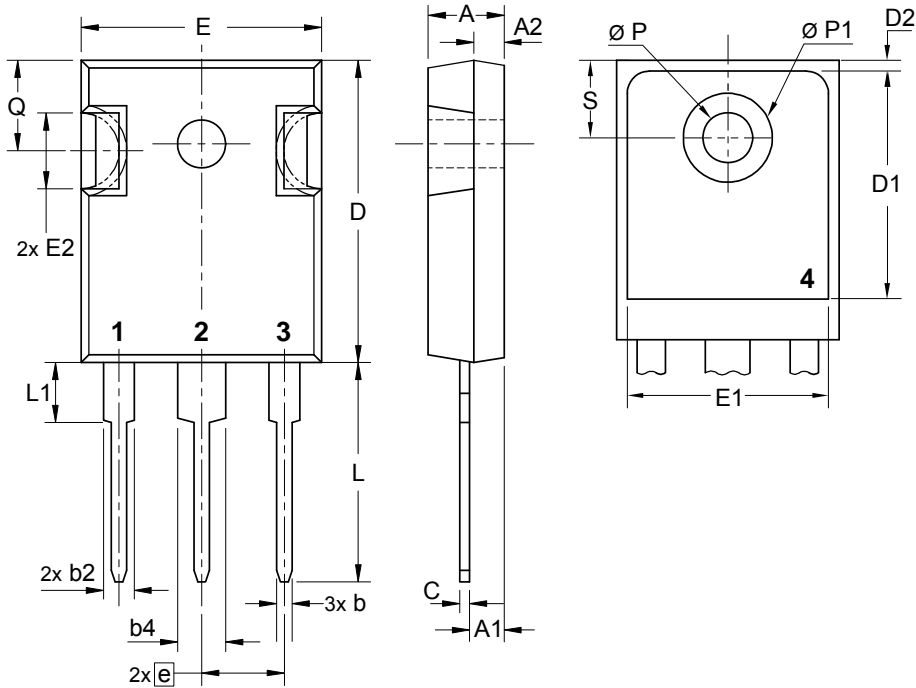

Sym.	Inches		Millimeter	
	min.	max.	min.	max.
A	0.185	0.209	4.70	5.30
A1	0.087	0.102	2.21	2.59
A2	0.059	0.098	1.50	2.49
D	0.819	0.845	20.79	21.45
E	0.610	0.640	15.48	16.24
E2	0.170	0.216	4.31	5.48
e	0.215 BSC		5.46 BSC	
L	0.780	0.800	19.80	20.30
L1	-	0.177	-	4.49
Ø P	0.140	0.144	3.55	3.65
Q	0.212	0.244	5.38	6.19
S	0.242 BSC		6.14 BSC	
b	0.039	0.055	0.99	1.40
b2	0.065	0.094	1.65	2.39
b4	0.102	0.135	2.59	3.43
c	0.015	0.035	0.38	0.89
D1	0.515	-	13.07	-
D2	0.020	0.053	0.51	1.35
E1	0.530	-	13.45	-
Ø P1	-	0.29	-	7.39

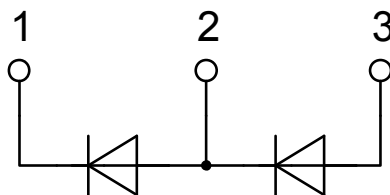

Rectifier

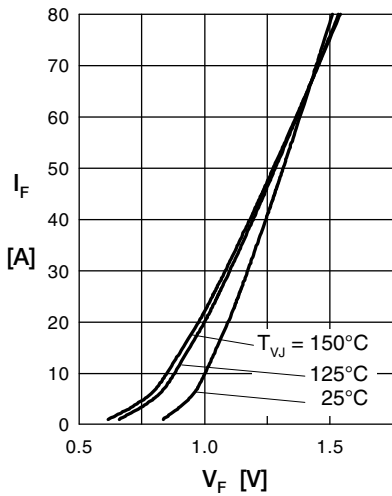

Fig. 1 Forward current versus voltage drop per diode

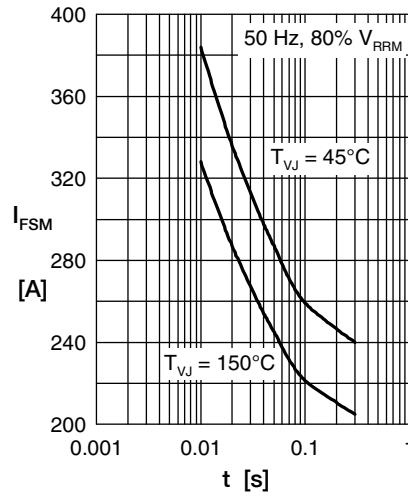

Fig. 2 Surge overload current

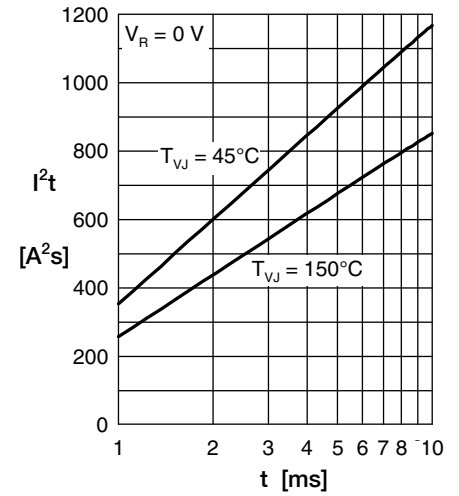

Fig. 3 I^2t versus time per diode

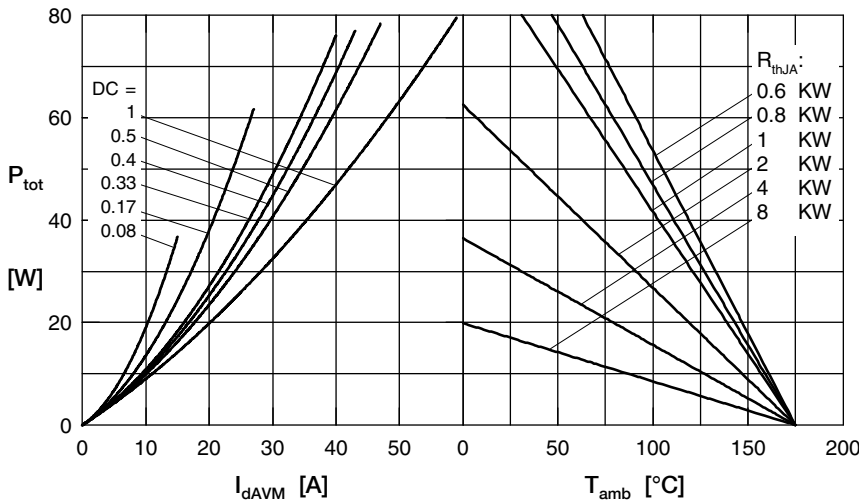

Fig. 4 Power dissipation vs. direct output current & ambient temperature

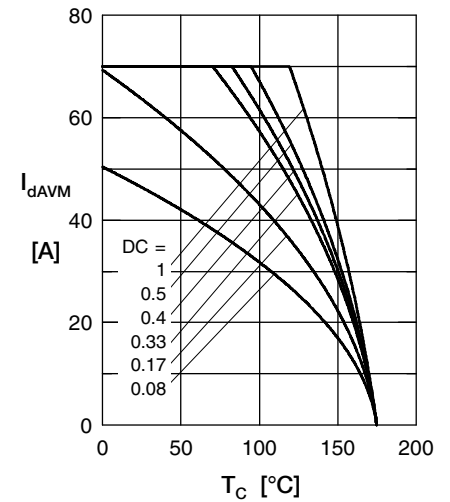

Fig. 5 Max. forward current vs. case temperature

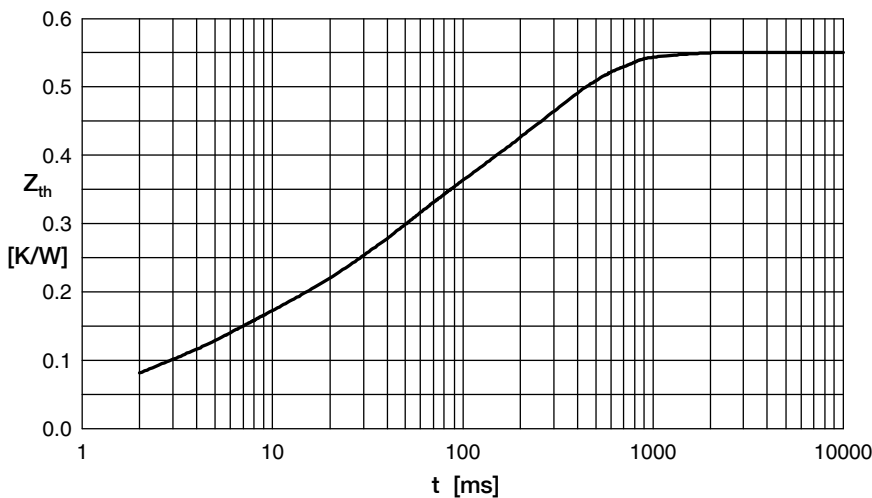

Fig. 6 Transient thermal impedance junction to case

i	R_i	t_i
1	0.033	0.0006
2	0.095	0.0039
3	0.164	0.033
4	0.258	0.272

单击下面可查看定价，库存，交付和生命周期等信息

[>>Littelfuse\(美国力特\)](#)