



# Thyristor

$$V_{RRM} = 1600\text{ V}$$

$$I_{TAV} = 30\text{ A}$$

$$V_T = 1.3\text{ V}$$

## Single Thyristor

Part number

**CS30-16io1**



Backside: anode



### Features / Advantages:

- Thyristor for line frequency
- Planar passivated chip
- Long-term stability

### Applications:

- Line rectifying 50/60 Hz
- Softstart AC motor control
- DC Motor control
- Power converter
- AC power control
- Lighting and temperature control

### Package: TO-247

- Industry standard outline
- RoHS compliant
- Epoxy meets UL 94V-0

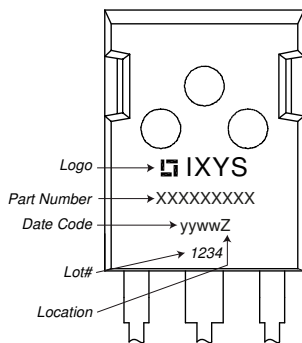
### Disclaimer Notice

Information furnished is believed to be accurate and reliable. However, users should independently evaluate the suitability of and test each product selected for their own applications. Littelfuse products are not designed for, and may not be used in, all applications. Read complete Disclaimer Notice at [www.littelfuse.com/disclaimer-electronics](http://www.littelfuse.com/disclaimer-electronics).



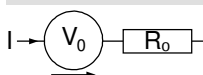
Thyristor				Ratings			
Symbol	Definition	Conditions	min.	typ.	max.	Unit	
$V_{RSM/DSM}$	max. non-repetitive reverse/forward blocking voltage	$T_{VJ} = 25^{\circ}C$			1700	V	
$V_{RRM/DRM}$	max. repetitive reverse/forward blocking voltage	$T_{VJ} = 25^{\circ}C$			1600	V	
$I_{RD}$	reverse current, drain current	$V_{R/D} = 1600 V$	$T_{VJ} = 25^{\circ}C$		50	$\mu A$	
		$V_{R/D} = 1600 V$	$T_{VJ} = 125^{\circ}C$		2	mA	
$V_T$	forward voltage drop	$I_T = 30 A$	$T_{VJ} = 25^{\circ}C$		1.30	V	
		$I_T = 60 A$			1.63	V	
		$I_T = 30 A$	$T_{VJ} = 125^{\circ}C$		1.30	V	
		$I_T = 60 A$			1.71	V	
$I_{TAV}$	average forward current	$T_C = 120^{\circ}C$	$T_{VJ} = 150^{\circ}C$		30	A	
$I_{T(RMS)}$	RMS forward current	180° sine			47	A	
$V_{T0}$	threshold voltage	} for power loss calculation only	$T_{VJ} = 150^{\circ}C$		0.87	V	
$r_T$	slope resistance				14.2	m $\Omega$	
$R_{thJC}$	thermal resistance junction to case				0.5	K/W	
$R_{thCH}$	thermal resistance case to heatsink			0.3		K/W	
$P_{tot}$	total power dissipation		$T_C = 25^{\circ}C$		250	W	
$I_{TSM}$	max. forward surge current	$t = 10 ms$ ; (50 Hz), sine	$T_{VJ} = 45^{\circ}C$		400	A	
		$t = 8,3 ms$ ; (60 Hz), sine	$V_R = 0 V$		430	A	
		$t = 10 ms$ ; (50 Hz), sine	$T_{VJ} = 150^{\circ}C$		340	A	
		$t = 8,3 ms$ ; (60 Hz), sine	$V_R = 0 V$		365	A	
$I^2t$	value for fusing	$t = 10 ms$ ; (50 Hz), sine	$T_{VJ} = 45^{\circ}C$		800	A <sup>2</sup> s	
		$t = 8,3 ms$ ; (60 Hz), sine	$V_R = 0 V$		770	A <sup>2</sup> s	
		$t = 10 ms$ ; (50 Hz), sine	$T_{VJ} = 150^{\circ}C$		580	A <sup>2</sup> s	
		$t = 8,3 ms$ ; (60 Hz), sine	$V_R = 0 V$		555	A <sup>2</sup> s	
$C_J$	junction capacitance	$V_R = 400 V$ $f = 1 MHz$	$T_{VJ} = 25^{\circ}C$		16	pF	
$P_{GM}$	max. gate power dissipation	$t_p = 30 \mu s$	$T_C = 150^{\circ}C$		10	W	
		$t_p = 300 \mu s$			5	W	
$P_{GAV}$	average gate power dissipation				0.5	W	
$(di/dt)_{cr}$	critical rate of rise of current	$T_{VJ} = 125^{\circ}C$ ; $f = 50 Hz$ repetitive, $I_T = 90 A$			150	A/ $\mu s$	
		$t_p = 200 \mu s$ ; $di_G/dt = 0.3 A/\mu s$ ; $I_G = 0.3 A$ ; $V = \frac{2}{3} V_{DRM}$ non-repet., $I_T = 30 A$			500	A/ $\mu s$	
$(dv/dt)_{cr}$	critical rate of rise of voltage	$V = \frac{2}{3} V_{DRM}$	$T_{VJ} = 125^{\circ}C$		1000	V/ $\mu s$	
		$R_{GK} = \infty$ ; method 1 (linear voltage rise)					
$V_{GT}$	gate trigger voltage	$V_D = 6 V$	$T_{VJ} = 25^{\circ}C$		1	V	
			$T_{VJ} = -40^{\circ}C$		1.2	V	
$I_{GT}$	gate trigger current	$V_D = 6 V$	$T_{VJ} = 25^{\circ}C$		55	mA	
			$T_{VJ} = -40^{\circ}C$		80	mA	
$V_{GD}$	gate non-trigger voltage	$V_D = \frac{2}{3} V_{DRM}$	$T_{VJ} = 125^{\circ}C$		0.2	V	
$I_{GD}$	gate non-trigger current				5	mA	
$I_L$	latching current	$t_p = 10 \mu s$	$T_{VJ} = 25^{\circ}C$		150	mA	
		$I_G = 0.3 A$ ; $di_G/dt = 0.3 A/\mu s$					
$I_H$	holding current	$V_D = 6 V$ $R_{GK} = \infty$	$T_{VJ} = 25^{\circ}C$		100	mA	
$t_{gd}$	gate controlled delay time	$V_D = \frac{1}{2} V_{DRM}$	$T_{VJ} = 25^{\circ}C$		2	$\mu s$	
		$I_G = 0.3 A$ ; $di_G/dt = 0.3 A/\mu s$					
$t_q$	turn-off time	$V_R = 100 V$ ; $I_T = 30 A$ ; $V = \frac{2}{3} V_{DRM}$ $T_{VJ} = 125^{\circ}C$ $di/dt = 15 A/\mu s$ $dv/dt = 20 V/\mu s$ $t_p = 200 \mu s$		150		$\mu s$	

Package TO-247			Ratings			
Symbol	Definition	Conditions	min.	typ.	max.	Unit
$I_{RMS}$	RMS current	per terminal			70	A
$T_{VJ}$	virtual junction temperature		-40		150	°C
$T_{op}$	operation temperature		-40		125	°C
$T_{stg}$	storage temperature		-40		150	°C
<b>Weight</b>				6		g
$M_D$	mounting torque		0.8		1.2	Nm
$F_C$	mounting force with clip		20		120	N

**Product Marking**


Ordering	Ordering Number	Marking on Product	Delivery Mode	Quantity	Code No.
Standard	CS30-16io1	CS30-16io1	Tube	30	466581

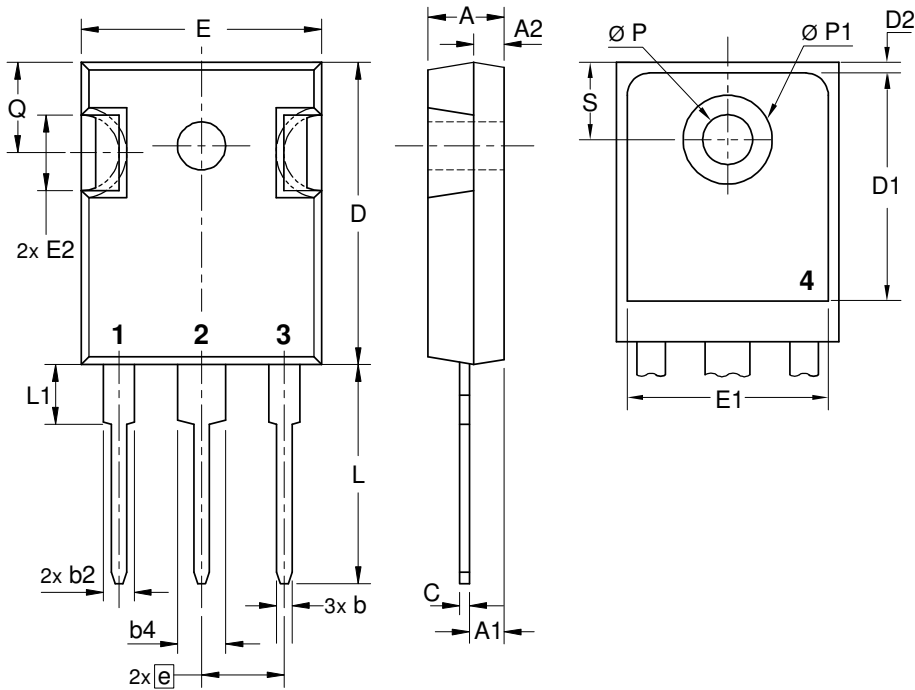
Similar Part	Package	Voltage class
CS30-12io1	TO-247AD (3)	1200
CS30-14io1	TO-247AD (3)	1400

**Equivalent Circuits for Simulation**
*\* on die level*
 $T_{VJ} = 150^{\circ}\text{C}$ 

**Thyristor**

$V_{0\ max}$	threshold voltage	0.87	V
$R_{0\ max}$	slope resistance *	11.7	mΩ



**Outlines TO-247**



Sym.	Inches		Millimeter	
	min.	max.	min.	max.
A	0.185	0.209	4.70	5.30
A1	0.087	0.102	2.21	2.59
A2	0.059	0.098	1.50	2.49
D	0.819	0.845	20.79	21.45
E	0.610	0.640	15.48	16.24
E2	0.170	0.216	4.31	5.48
e	0.215 BSC		5.46 BSC	
L	0.780	0.800	19.80	20.30
L1	-	0.177	-	4.49
Ø P	0.140	0.144	3.55	3.65
Q	0.212		5.38	
S	0.242 BSC		6.14 BSC	
b	0.039	0.055	0.99	1.40
b2	0.065	0.094	1.65	2.39
b4	0.102	0.135	2.59	3.43
c	0.015	0.035	0.38	0.89
D1	0.515	-	13.07	-
D2	0.020	0.053	0.51	1.35
E1	0.530	-	13.45	-
Ø P1	-	0.29	-	7.39



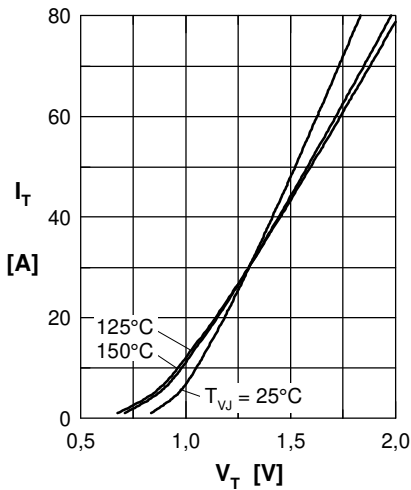
**Thyristor**


Fig. 1 Forward characteristics

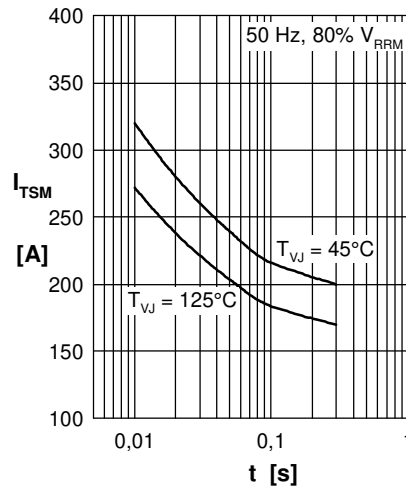


Fig. 2 Surge overload current

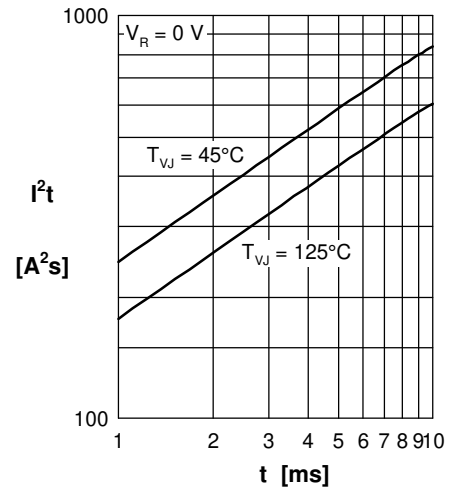
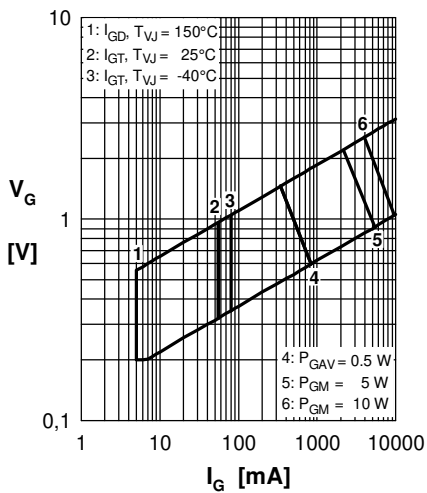

 Fig. 3  $I^2t$  versus time (1-10 ms)


Fig. 4 Gate trigger characteristics



Fig. 5 Gate controlled delay time

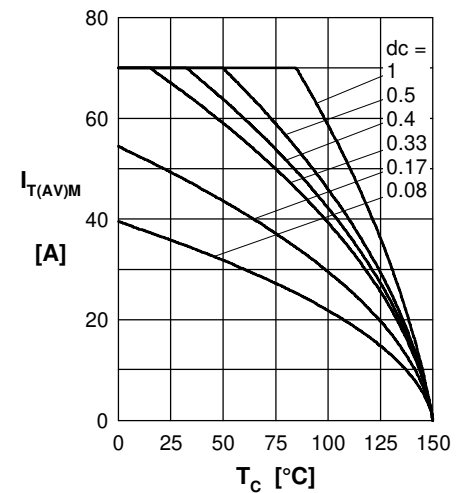


Fig. 6 Max. forward current at case temperature

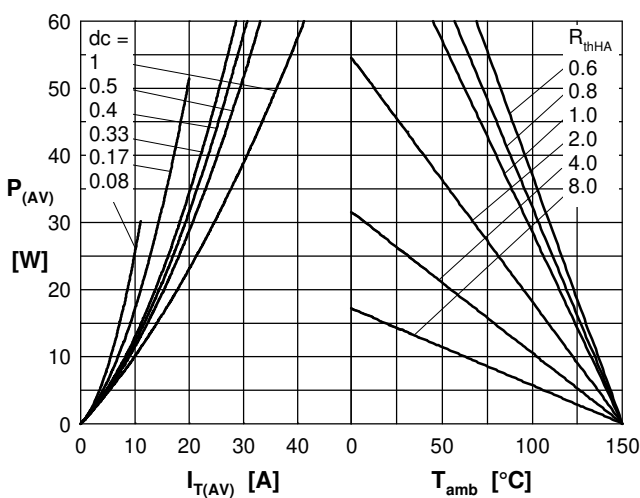
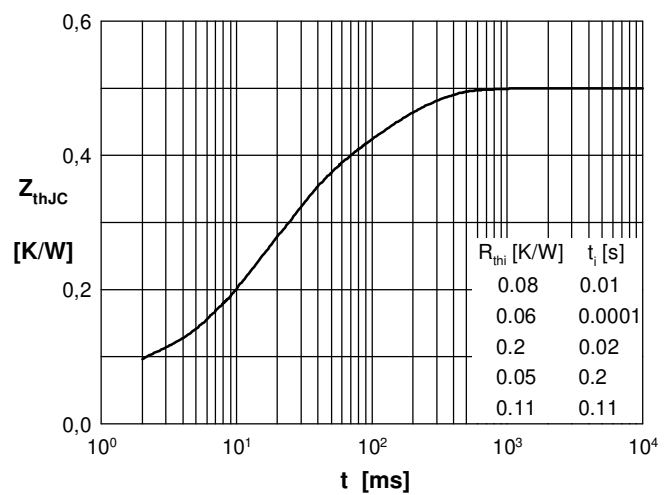

 Fig. 7a Power dissipation versus direct output current  
 Fig. 7b and ambient temperature


Fig. 8 Transient thermal impedance junction to case



单击下面可查看定价，库存，交付和生命周期等信息

[>>Littelfuse\(美国力特\)](#)