

LSIC1MO120E0160 1200 V N-channel, Enhancement-mode SiC MOSFET



**Product Summary**

Characteristics	Value	Unit
$V_{DS}$	1200	V
Typical $R_{DS(ION)}$	160	m $\Omega$
$I_D$ ( $T_C \leq 100^\circ C$ )	14	A

**Circuit Diagram TO-247-3L**

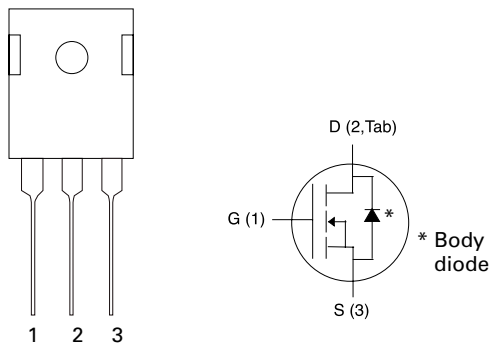

**Features**

- Optimized for high-frequency, high-efficiency applications
- Extremely low gate charge and output capacitance
- Low gate resistance for high-frequency switching
- Normally-off operation at all temperatures
- Ultra-low on-resistance
- Halogen-free, RoHS compliant and lead-free

**Environmental**

- Littelfuse "RoHS" logo = RoHS conform
- Littelfuse "HF" logo = Halogen Free
- Littelfuse "Pb-free" logo = Pb-free lead plating

**Applications**

- High-frequency applications
- Solar Inverters
- Switch Mode Power Supplies
- UPS
- Motor Drives
- High Voltage DC/DC Converters
- Battery Chargers
- Induction Heating

### Maximum Ratings

Characteristics	Symbol	Conditions	Value	Unit
Continuous Drain Current	$I_D$	$V_{GS} = 20\text{ V}, T_C = 25\text{ }^\circ\text{C}$	22	A
		$V_{GS} = 20\text{ V}, T_C = 100\text{ }^\circ\text{C}$	14	
Pulsed Drain Current <sup>1</sup>	$I_{D(pulse)}$	$T_C = 25\text{ }^\circ\text{C}$	44	A
Power Dissipation	$P_D$	$T_C = 25\text{ }^\circ\text{C}, T_J = 150\text{ }^\circ\text{C}$	125	W
Operating Junction Temperature	$T_J$		-55 to 150	$^\circ\text{C}$
Gate-source Voltage	$V_{GS,MAX}$	Absolute maximum values	-6 to 22	V
	$V_{GS,OP,TR}$	Transient, <1% duty cycle	-10 to 25	
	$V_{GS,OP}$	Recommended DC operating values	-5 to 20	
Storage Temperature	$T_{STG}$	-	-55 to 150	$^\circ\text{C}$
Lead Temperature for Soldering	$T_{solid}$	-	260	$^\circ\text{C}$
Mounting Torque	$M_D$	M3 or 6-32 screw	0.6	Nm
			5.3	in-lb

Footnote 1: Pulse width limited by  $T_{J,max}$

### Thermal Characteristics

Characteristics	Symbol	Value	Unit
Maximum Thermal Resistance, junction-to-case	$R_{th,JC,max}$	1.0	$^\circ\text{C/W}$
Maximum Thermal Resistance, junction-to-ambient	$R_{th,JA,max}$	40	$^\circ\text{C/W}$

### Electrical Characteristics ( $T_J = 25\text{ }^\circ\text{C}$ unless otherwise specified)

Characteristics	Symbol	Conditions	Min	Typ	Max	Unit
Static Characteristics						
Drain-source Breakdown Voltage	$V_{(BR)DSS}$	$V_{GS} = 0\text{ V}, I_D = 250\text{ }\mu\text{A}$	1200	-	-	V
Zero Gate Voltage Drain Current	$I_{DSS}$	$V_{DS} = 1200\text{ V}, V_{GS} = 0\text{ V}$	-	1	100	$\mu\text{A}$
		$V_{DS} = 1200\text{ V}, V_{GS} = 0\text{ V}, T_J = 150\text{ }^\circ\text{C}$	-	2	-	
Gate Leakage Current	$I_{GSS,F}$	$V_{GS} = 22\text{ V}, V_{DS} = 0\text{ V}$	-	-	100	nA
	$I_{GSS,R}$	$V_{GS} = -6\text{ V}, V_{DS} = 0\text{ V}$	-	-	100	
Drain-source On-state Resistance	$R_{DS(ON)}$	$I_D = 10\text{ A}, V_{GS} = 20\text{ V}$	-	160	200	m $\Omega$
		$I_D = 10\text{ A}, V_{GS} = 20\text{ V}, T_J = 150\text{ }^\circ\text{C}$	-	210	-	
Gate Threshold Voltage	$V_{GS(th)}$	$V_{DS} = V_{GS}, I_D = 5\text{ mA}$	1.8	2.8	4.0	V
		$V_{DS} = V_{GS}, I_D = 5\text{ mA}, T_J = 150\text{ }^\circ\text{C}$	-	1.9	-	
Gate Resistance	$R_G$	Resonance method, Drain-Source shorted	-	0.95	-	$\Omega$

### Electrical Characteristics (T<sub>J</sub> = 25 °C unless otherwise specified)

Characteristics	Symbol	Conditions	Value			Unit
			Min	Typ	Max	
Dynamic Characteristics						
Turn-on Switching Energy	E <sub>ON</sub>	V <sub>DD</sub> = 800 V, I <sub>D</sub> = 10 A, V <sub>GS</sub> = -5/+20 V, R <sub>G,ext</sub> = 5 Ω, L = 1.4mH, FWD=LSIC2SD120A05	-	77	-	μJ
Turn-off Switching Energy	E <sub>OFF</sub>		-	59	-	
Total Per-cycle Switching Energy	E <sub>TS</sub>		-	136	-	
Input Capacitance	C <sub>ISS</sub>	V <sub>DD</sub> = 800 V, V <sub>GS</sub> = 0 V, f = 1 MHz, V <sub>AC</sub> = 25 mV	-	870	-	pF
Output Capacitance	C <sub>OSS</sub>		-	45	-	
Reverse Transfer Capacitance	C <sub>RSS</sub>		-	7	-	
C <sub>OSS</sub> Stored Energy	E <sub>OSS</sub>		-	14	-	
Total Gate Charge	Q <sub>g</sub>	V <sub>DD</sub> = 800 V, I <sub>D</sub> = 10 A, V <sub>GS</sub> = -5/+20 V	-	57	-	nC
Gate-source Charge	Q <sub>gs</sub>		-	14	-	
Gate-drain Charge	Q <sub>gd</sub>		-	20	-	
Turn-on Delay Time	t <sub>d(on)</sub>	V <sub>DD</sub> = 800 V, V <sub>GS</sub> = -5/+20 V, I <sub>D</sub> = 10 A, R <sub>G,ext</sub> = 5 Ω, R <sub>L</sub> = 80 Ω, Timing relative to V <sub>DS</sub>	-	12	-	ns
Rise Time	t <sub>r</sub>		-	8	-	
Turn-off Delay Time	t <sub>d(off)</sub>		-	19	-	
Fall Time	t <sub>f</sub>		-	14	-	

### Reverse Diode Characteristics

Characteristics	Symbol	Conditions	Value			Unit
			Min	Typ	Max	
Diode Forward Voltage	V <sub>SD</sub>	I <sub>S</sub> = 5 A, V <sub>GS</sub> = 0 V	-	3.8	-	V
		I <sub>S</sub> = 5 A, V <sub>GS</sub> = 0 V, T <sub>J</sub> = 150 °C	-	3.4	-	
Continuous Diode Forward Current	I <sub>S</sub>	V <sub>GS</sub> = 0 V, T <sub>C</sub> = 25 °C	-	-	24	A
Peak Diode Forward Current <sup>1</sup>	I <sub>SP</sub>		-	-	44	

Footnote 1: Pulse width limited by T<sub>J,max</sub>

**Figure 1: Maximum Power Dissipation ( $T_j = 150\text{ }^\circ\text{C}$ )**

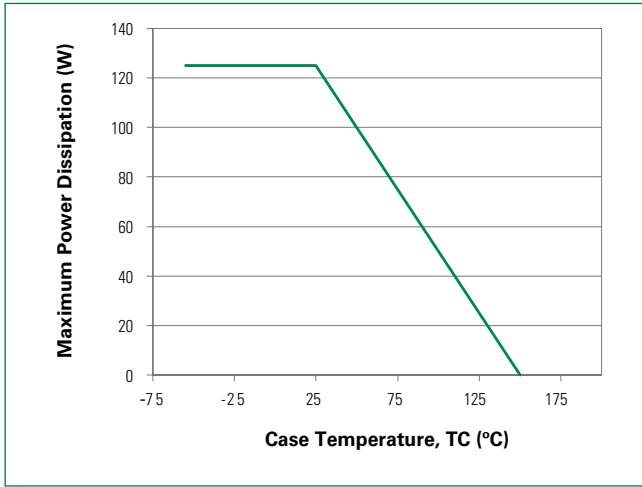

**Figure 2: Transfer Characteristics ( $V_{DS} = 10\text{ V}$ )**

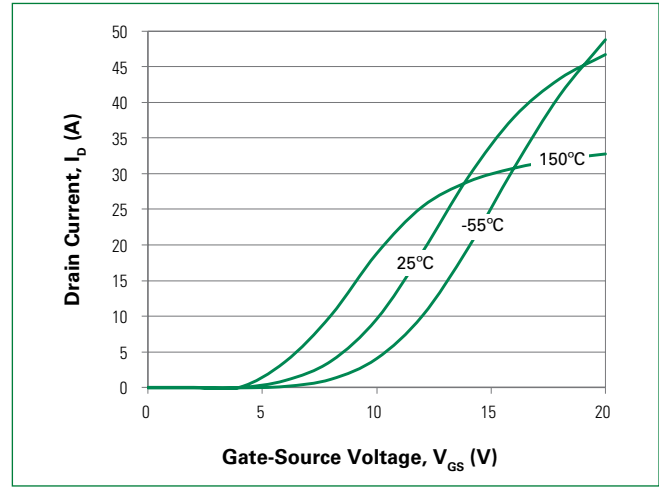

**Figure 3: Output Characteristics ( $T_j = 25\text{ }^\circ\text{C}$ )**

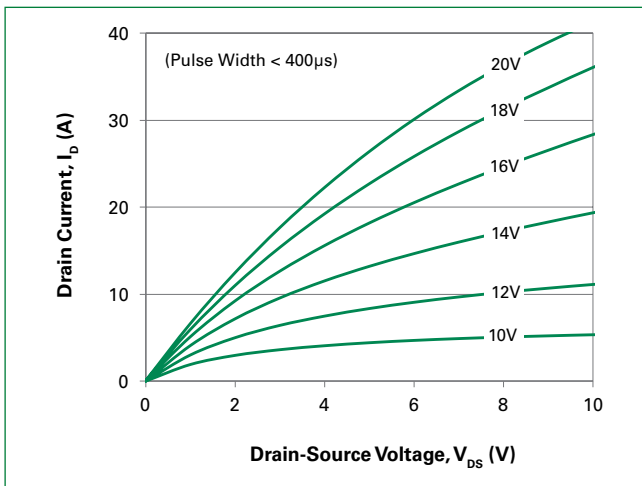

**Figure 4: Output Characteristics ( $T_j = 150\text{ }^\circ\text{C}$ )**

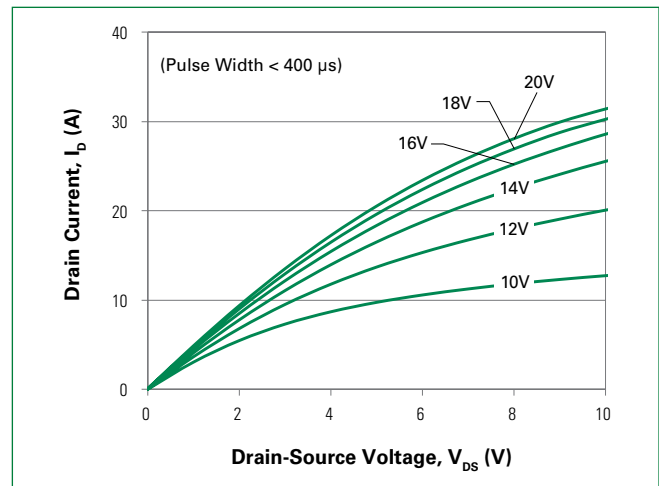

**Figure 5: Output Characteristics ( $T_j = -55\text{ }^\circ\text{C}$ )**

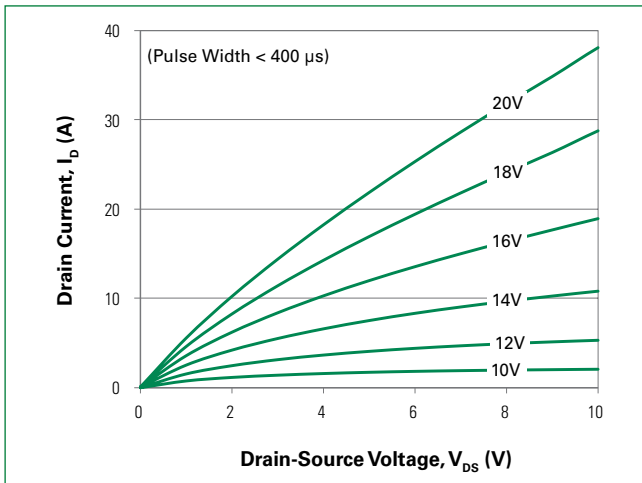

**Figure 6: Reverse Conduction Characteristics ( $T_j = 25\text{ }^\circ\text{C}$ )**

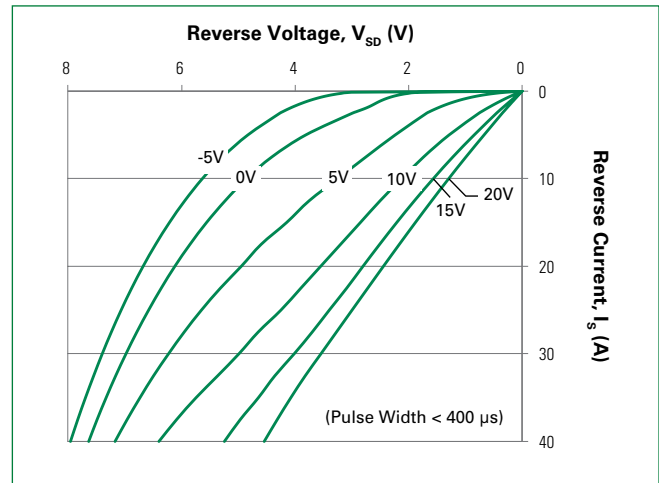

**Figure 7: Reverse Conduction Characteristics ( $T_j = 150^\circ\text{C}$ )**

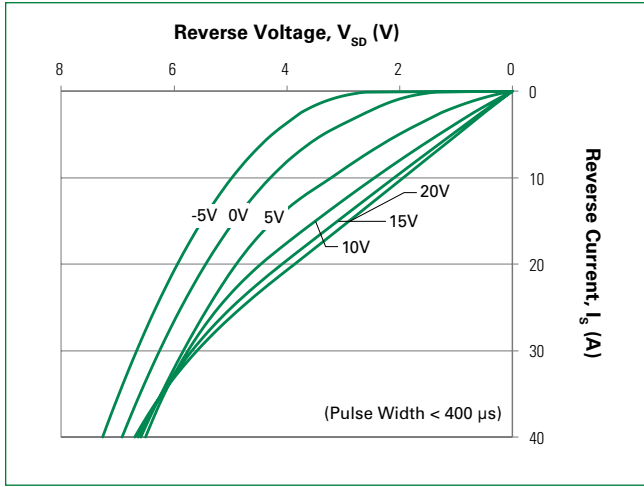

**Figure 8: Reverse Conduction Characteristics ( $T_j = -55^\circ\text{C}$ )**

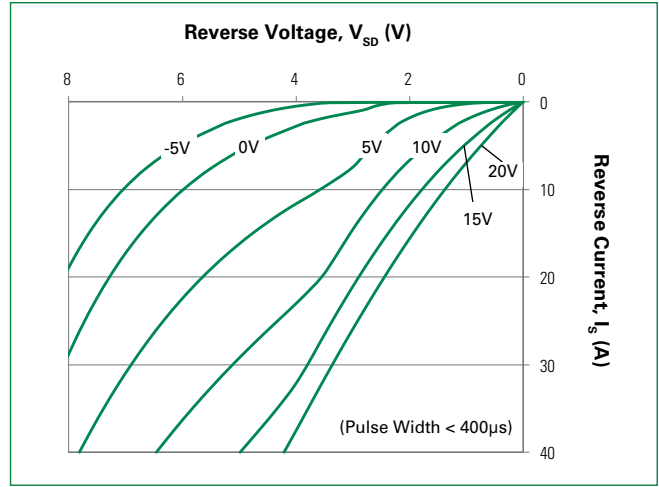

**Figure 9: Transient Thermal Impedance**

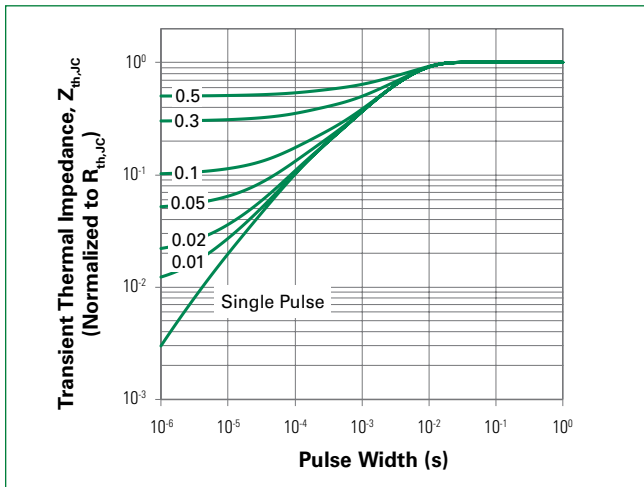

**Figure 10: Safe Operating Area ( $T_c = 25^\circ\text{C}$ )**

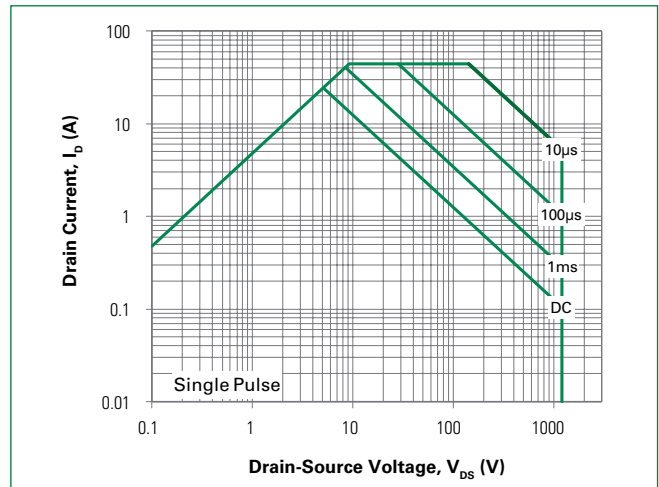

**Figure 11: On-resistance vs. Drain Current**

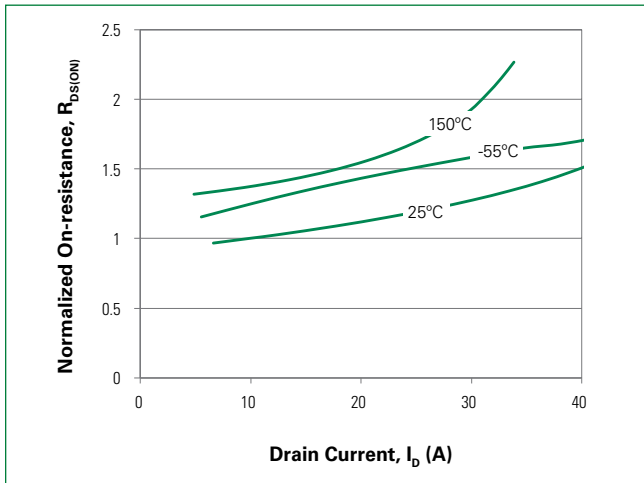

**Figure 12: Normalized On-resistance**

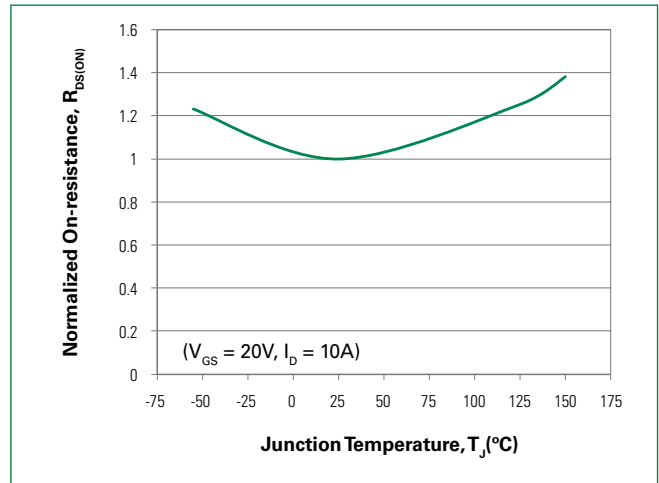

**Figure 13: Threshold Voltage**

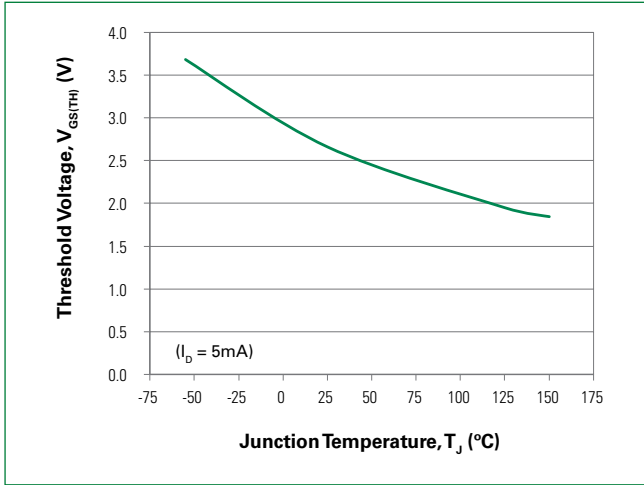

**Figure 14: Drain-Source Blocking Voltage**

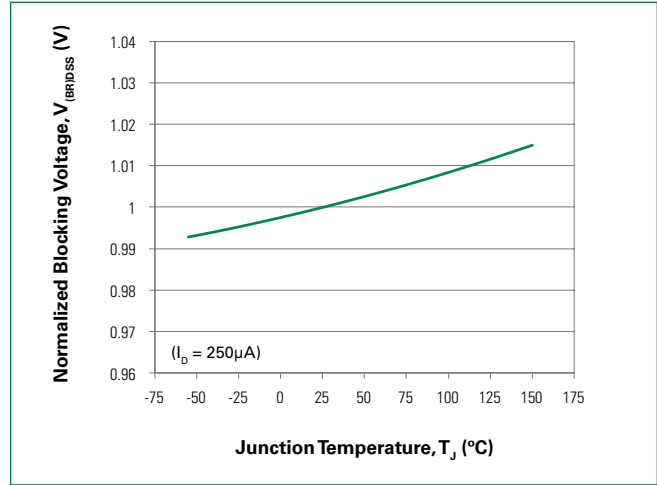

**Figure 15: Junction Capacitances**

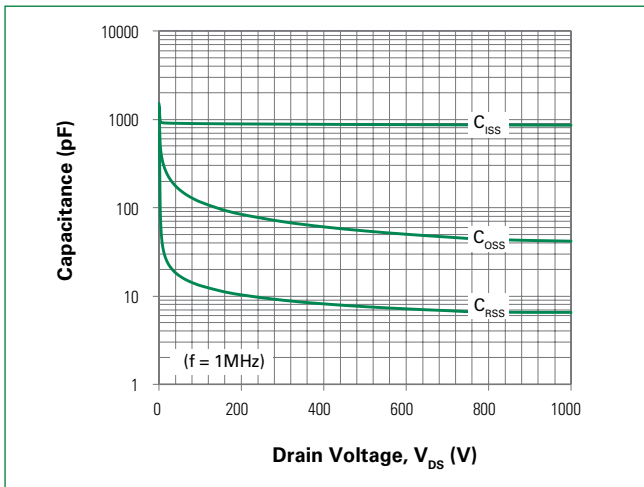

**Figure 16: Junction Capacitances**

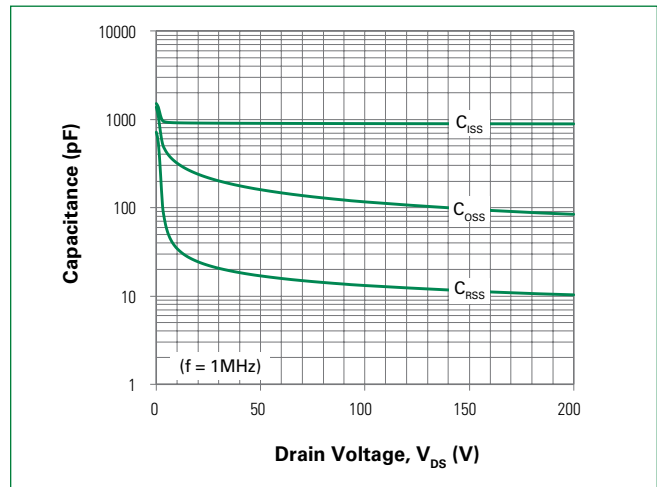

**Figure 17:  $C_{OSS}$  Stored Energy  $E_{OSS}$**

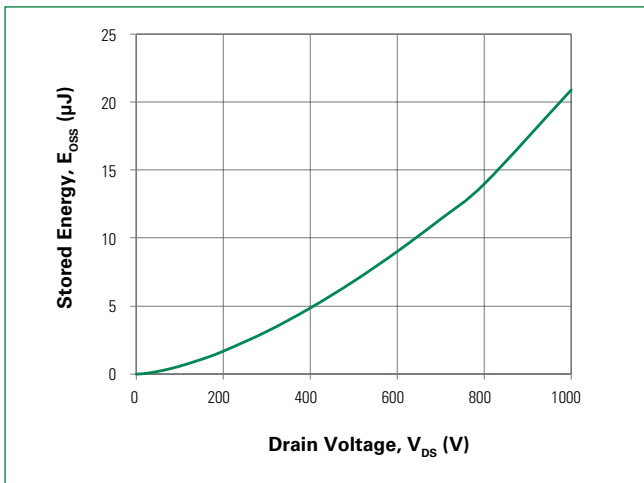

**Figure 18: Gate Charge**

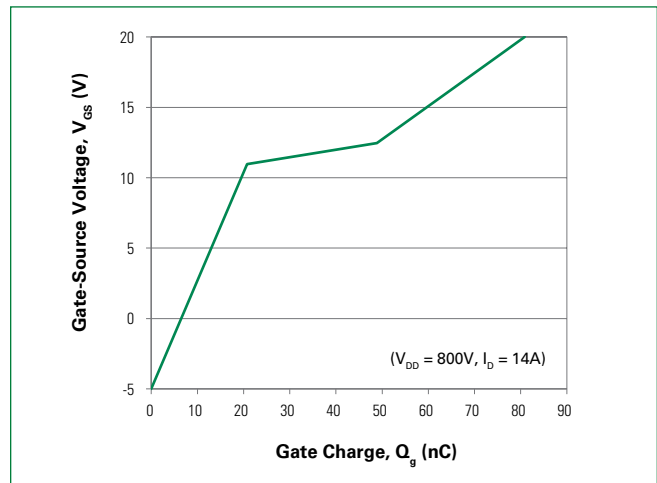

**Figure 19: Switching Energy vs. Drain Current**

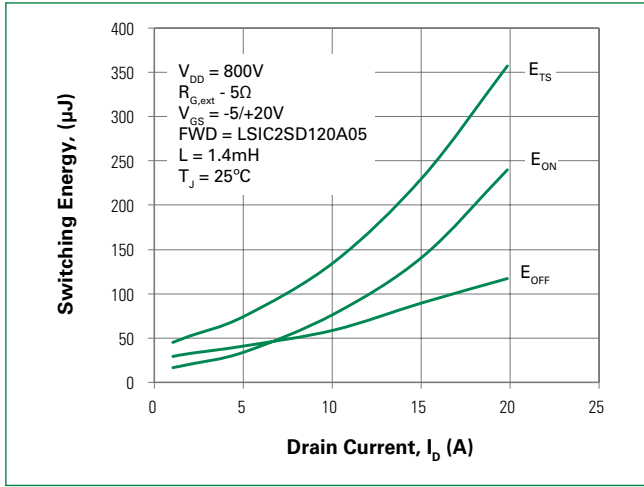

**Figure 20: Switching Energy vs. Gate Resistance**

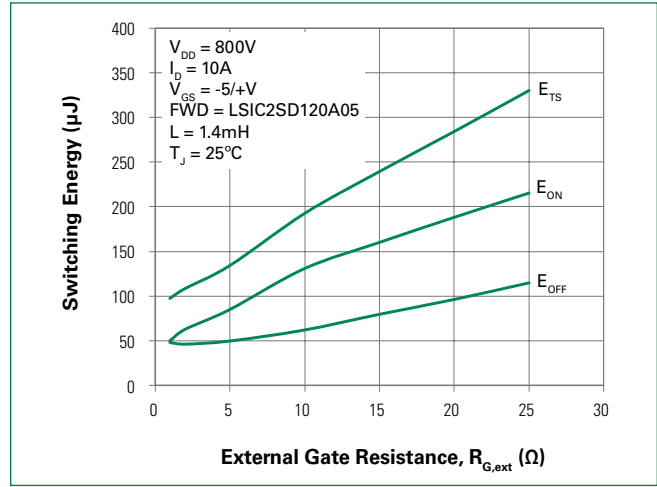

**Package Dimensions TO-247-3L**

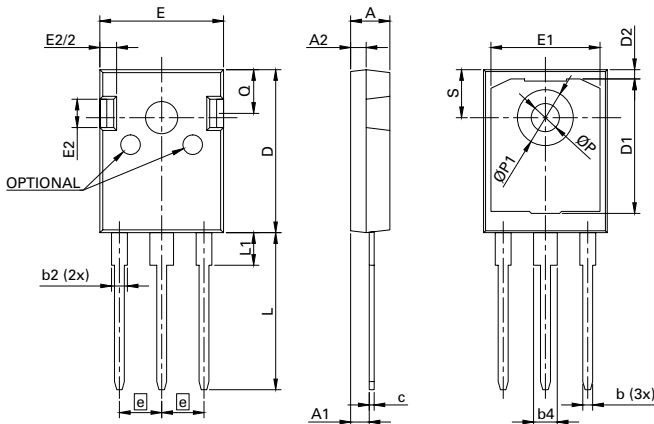

- Notes:
1. Dimensions are in millimeters
  2. Dimension D, E do not include mold flash. Mold flash shall not exceed 0.127 mm per side measured at outer most extreme of plastic body.
  3.  $\phi P$  to have a maximum draft angle of 38.1 mm to the top of the part with a maximum hole diameter of 3.912 mm.

**Recommended Hole Pattern Layout**

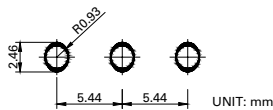

Symbol	Millimeters		
	Min	Nom	Max
A	4.80	5.03	5.20
A1	2.25	2.38	2.54
A2	1.85	1.98	2.11
b	0.99	-	1.40
b2	1.65	-	2.39
b4	2.59	-	3.43
c	0.38	0.64	0.89
D	20.80	20.96	21.34
D1	13.50	-	-
D2	0.51	1.19	1.35
e	5.44 BSC		
E	15.75	15.90	16.13
E1	13.06	14.02	14.15
E2	4.19	4.32	4.83
L	19.81	20.19	20.57
L1	3.81	4.19	4.45
$\phi P$	3.55	3.61	3.66
$\phi P1$	7.06	7.19	7.32
Q	5.49	5.61	6.20
S	6.05	6.17	6.30

### Part Numbering and Marking System

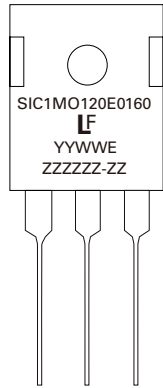

**SIC** = SiC  
**1** = Gen1  
**MO** = MOSFET  
**120** = Voltage Rating (1200 V)  
**E** = TO-247-3L  
**0160** =  $R_{DS(ON)}$  (160 mOhm)  
**YY** = Year  
**WW** = Week  
**E** = Special Code  
**ZZZZZZ-ZZ** = Lot Number

### Packing Options

Part Number	Marking	Packing Mode	M.O.Q
LSIC1MO120E0160	SIC1MO120E0160	Tube (30pcs)	450

### Packing Specification TO-247-3L

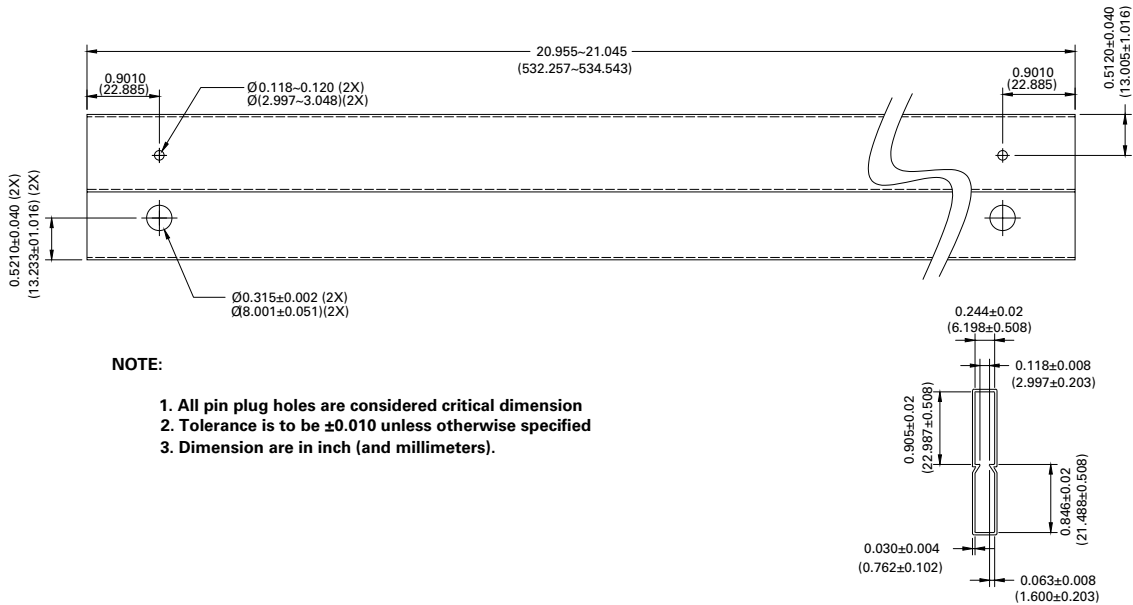

**Disclaimer Notice** - Littelfuse products are not designed for, and shall not be used for, any purpose (including, without limitation, automotive, military, aerospace, medical, life-saving, life-sustaining or nuclear facility applications, devices intended for surgical implant into the body, or any other application in which the failure or lack of desired operation of the product may result in personal injury, death, or property damage) other than those expressly set forth in applicable Littelfuse product documentation. Warranties granted by Littelfuse shall be deemed void for products used for any purpose not expressly set forth in applicable Littelfuse documentation. Littelfuse shall not be liable for any claims or damages arising out of products used in applications not expressly intended by Littelfuse as set forth in applicable Littelfuse documentation. The sale and use of Littelfuse products is subject to Littelfuse Terms and Conditions of Sale, unless otherwise agreed by Littelfuse. Information furnished is believed to be accurate and reliable. However, users should independently evaluate the suitability of and test each product selected for their own applications. Littelfuse products are not designed for, and may not be used in, all applications. Read complete Disclaimer Notice at [www.littelfuse.com/disclaimer-electronics](http://www.littelfuse.com/disclaimer-electronics).



单击下面可查看定价，库存，交付和生命周期等信息

[>>Littelfuse\(美国力特\)](#)