

## XPT IGBT

$$V_{CES} = 1200V$$

$$I_{C25} = 88A$$

$$V_{CE(sat)} = 1.8V$$

Copack

Part number

IXA60IF1200NA



Backside: isolated

E72873

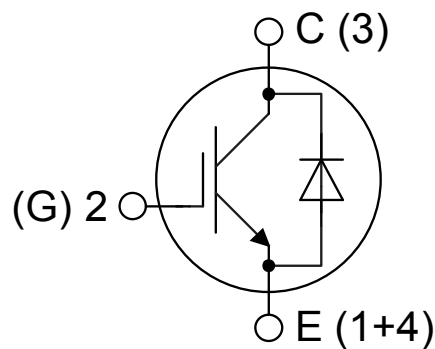
**Features / Advantages:**

- Easy paralleling due to the positive temperature coefficient of the on-state voltage
- Rugged XPT design (Xtreme light Punch Through) results in:
  - short circuit rated for 10  $\mu$ sec.
  - very low gate charge
  - low EMI
  - square RBSOA @ 3x  $I_c$
- Thin wafer technology combined with the XPT design results in a competitive low  $V_{CE(sat)}$
- SONIC™ diode
  - fast and soft reverse recovery
  - low operating forward voltage

**Applications:**

- AC motor drives
- Solar inverter
- Medical equipment
- Uninterruptible power supply
- Air-conditioning systems
- Welding equipment
- Switched-mode and resonant-mode power supplies
- Inductive heating, cookers
- Pumps, Fans

**Package:** SOT-227B (minibloc)

- Isolation Voltage: 3000 V~
- Industry standard outline
- RoHS compliant
- Epoxy meets UL 94V-0
- Base plate: Copper internally DCB isolated
- Advanced power cycling
- Either emitter terminal can be used as main or Kelvin emitter

IGBT				Ratings			
Symbol	Definition	Conditions	min.	typ.	max.	Unit	
$V_{CES}$	collector emitter voltage	$T_{VJ} = 25^{\circ}C$			1200	V	
$V_{GES}$	max. DC gate voltage				$\pm 20$	V	
$V_{GEM}$	max. transient gate emitter voltage				$\pm 30$	V	
$I_{C25}$	collector current	$T_C = 25^{\circ}C$			88	A	
$I_{C80}$		$T_C = 80^{\circ}C$			56	A	
$P_{tot}$	total power dissipation	$T_C = 25^{\circ}C$			290	W	
$V_{CE(sat)}$	collector emitter saturation voltage	$I_C = 50A; V_{GE} = 15V$		1.8	2.1	V	
				2.1		V	
$V_{GE(th)}$	gate emitter threshold voltage	$I_C = 2mA; V_{GE} = V_{CE}$	5.4	5.9	6.5	V	
$I_{CES}$	collector emitter leakage current	$V_{CE} = V_{CES}; V_{GE} = 0V$			0.1	mA	
				0.1		mA	
$I_{GES}$	gate emitter leakage current	$V_{GE} = \pm 20V$			500	nA	
$Q_{G(on)}$	total gate charge	$V_{CE} = 600V; V_{GE} = 15V; I_C = 50A$		190		nC	
$t_{d(on)}$	turn-on delay time	inductive load $V_{CE} = 600V; I_C = 50A$ $V_{GE} = \pm 15V; R_G = 15\Omega$		70		ns	
$t_r$	current rise time		$T_{VJ} = 125^{\circ}C$	40		ns	
$t_{d(off)}$	turn-off delay time		250		ns		
$t_f$	current fall time		100		ns		
$E_{on}$	turn-on energy per pulse		4.5		mJ		
$E_{off}$	turn-off energy per pulse		5.5		mJ		
<b>RBSOA</b>	reverse bias safe operating area	$V_{GE} = \pm 15V; R_G = 15\Omega$					
$I_{CM}$		$V_{CEmax} = 1200V$			150	A	
<b>SCSOA</b>	short circuit safe operating area	$V_{CEmax} = 1200V$					
$t_{sc}$	short circuit duration	$V_{CE} = 900V; V_{GE} = \pm 15V$			10	$\mu s$	
$I_{sc}$	short circuit current	$R_G = 15\Omega; \text{non-repetitive}$		200		A	
$R_{thJC}$	thermal resistance junction to case				0.43	K/W	
$R_{thCH}$	thermal resistance case to heatsink			0.10		K/W	
<b>Diode</b>							
$V_{RRM}$	max. repetitive reverse voltage	$T_{VJ} = 25^{\circ}C$			1200	V	
$I_{F25}$	forward current	$T_C = 25^{\circ}C$			85	A	
$I_{F80}$		$T_C = 80^{\circ}C$			51	A	
$V_F$	forward voltage	$I_F = 60A$			2.20	V	
				1.95		V	
$I_R$	reverse current	$V_R = V_{RRM}$			*	mA	
	* not applicable, see Ices at IGBT				*	mA	
$Q_{rr}$	reverse recovery charge	$V_R = 600V$ $-di_F/dt = E+03 A/\mu s$ $I_F = 60A; V_{GE} = 0V$		8		$\mu C$	
$I_{RM}$	max. reverse recovery current		$T_{VJ} = 125^{\circ}C$	60		A	
$t_{rr}$	reverse recovery time		350		ns		
$E_{rec}$	reverse recovery energy		2.5		mJ		
$R_{thJC}$	thermal resistance junction to case				0.6	K/W	
$R_{thCH}$	thermal resistance case to heatsink			0.10		K/W	

Package SOT-227B (minibloc)		Ratings				
Symbol	Definition	Conditions	min.	typ.	max.	Unit
$I_{RMS}$	RMS current	per terminal <sup>1)</sup>			150	A
$T_{VJ}$	virtual junction temperature		-40		150	°C
$T_{op}$	operation temperature		-40		125	°C
$T_{stg}$	storage temperature		-40		150	°C
<b>Weight</b>				30		g
$M_D$	mounting torque		1.1		1.5	Nm
$M_T$	terminal torque		1.1		1.5	Nm
$d_{Spp/APP}$	creepage distance on surface   striking distance through air	terminal to terminal	10.5	3.2		mm
$d_{Spb/APb}$		terminal to backside	8.6	6.8		mm
$V_{ISOL}$	isolation voltage	t = 1 second			3000	V
		t = 1 minute	50/60 Hz, RMS; $I_{ISOL} \leq 1$ mA		2500	V

<sup>1)</sup>  $I_{RMS}$  is typically limited by the pin-to-chip resistance (1); or by the current capability of the chip (2). In case of (1) and a product with multiple pins for one chip-potential, the current capability can be increased by connecting the pins as one contact.

### Product Marking

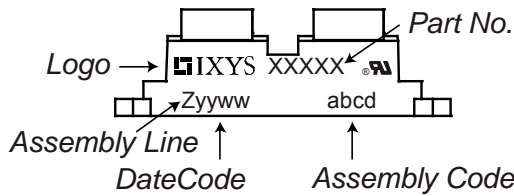

### Part description

- I = IGBT
- X = XPT IGBT
- A = Gen 1 / std
- 60 = Current Rating [A]
- IF = Copack
- 1200 = Reverse Voltage [V]
- NA = SOT-227B (minibloc)

Ordering	Ordering Number	Marking on Product	Delivery Mode	Quantity	Code No.
Standard	IXA60IF1200NA	IXA60IF1200NA	Tube	10	508765

Similar Part	Package	Voltage class
IXA70I1200NA	SOT-227B (minibloc)	1200

### Equivalent Circuits for Simulation

\* on die level

$T_{VJ} = 150$  °C

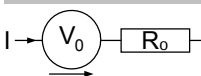

	IGBT	Diode	
$V_{0\ max}$	1.1	1.25	V
$R_{0\ max}$	28	14.2	mΩ

## Outlines SOT-227B (minibloc)

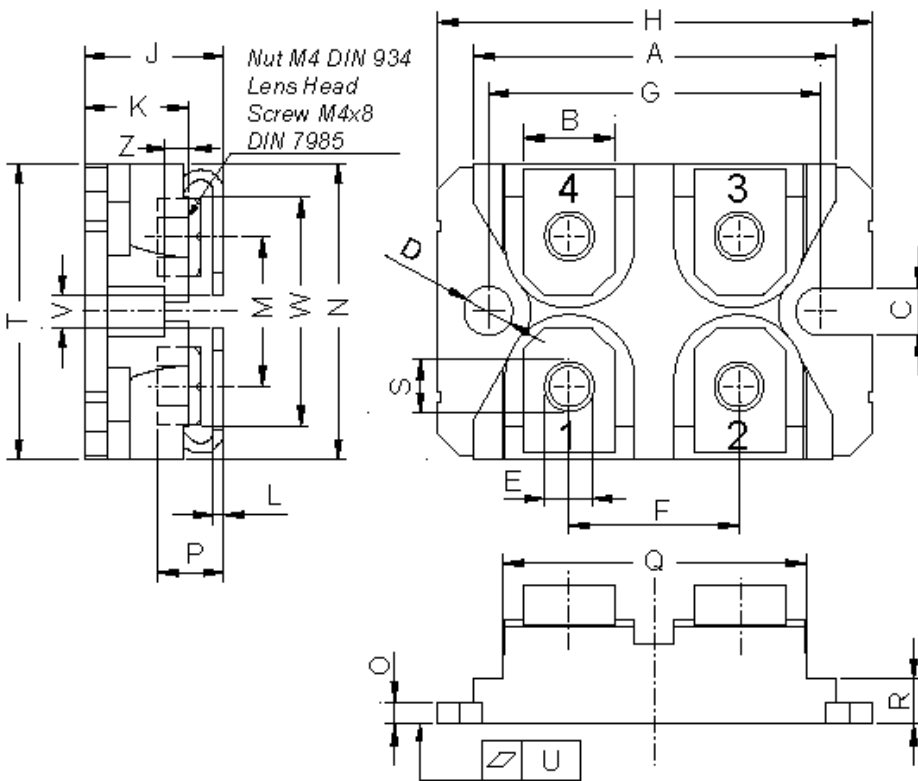

Dim.	Millimeter		Inches	
	min	max	min	max
A	31.50	31.88	1.240	1.255
B	7.80	8.20	0.307	0.323
C	4.09	4.29	0.161	0.169
D	4.09	4.29	0.161	0.169
E	4.09	4.29	0.161	0.169
F	14.91	15.11	0.587	0.595
G	30.12	30.30	1.186	1.193
H	37.80	38.23	1.488	1.505
J	11.68	12.22	0.460	0.481
K	8.92	9.60	0.351	0.378
L	0.74	0.84	0.029	0.033
M	12.50	13.10	0.492	0.516
N	25.15	25.42	0.990	1.001
O	1.95	2.13	0.077	0.084
P	4.95	6.20	0.195	0.244
Q	26.54	26.90	1.045	1.059
R	3.94	4.42	0.155	0.167
S	4.55	4.85	0.179	0.191
T	24.59	25.25	0.968	0.994
U	-0.05	0.10	-0.002	0.004
V	3.20	5.50	0.126	0.217
W	19.81	21.08	0.780	0.830
Z	2.50	2.70	0.098	0.106

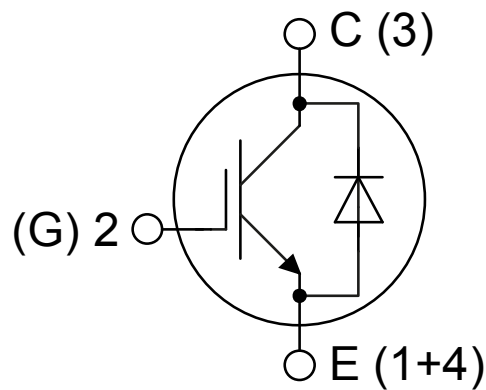

## IGBT

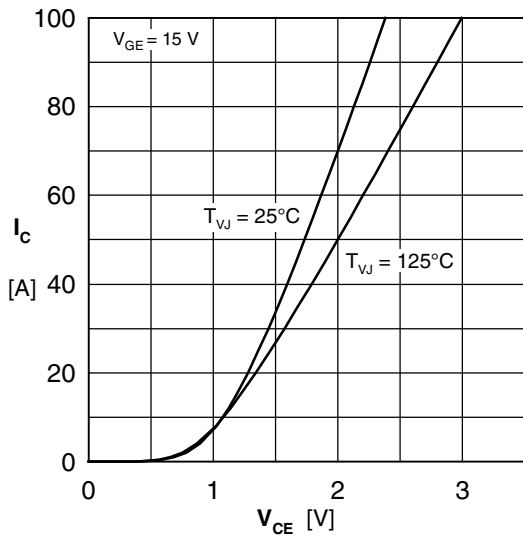

Fig. 1 Typ. output characteristics

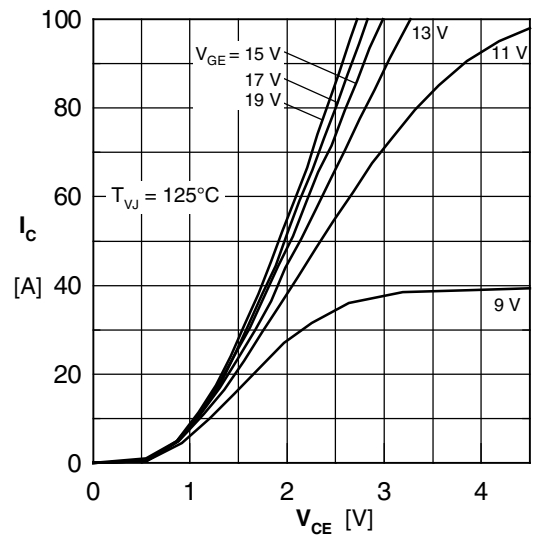

Fig. 2 Typ. output characteristics

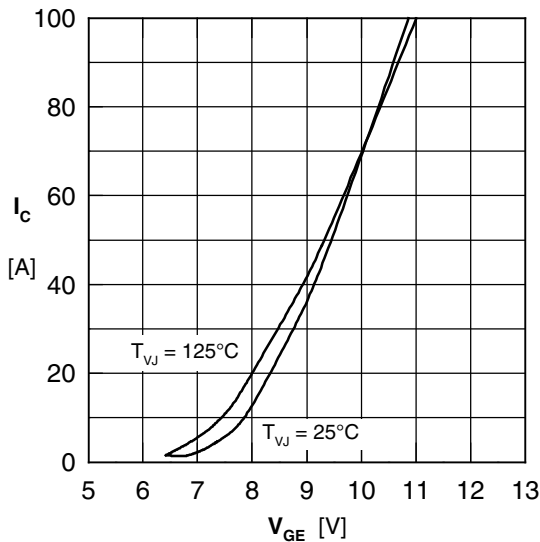

Fig. 3 Typ. transfer characteristics

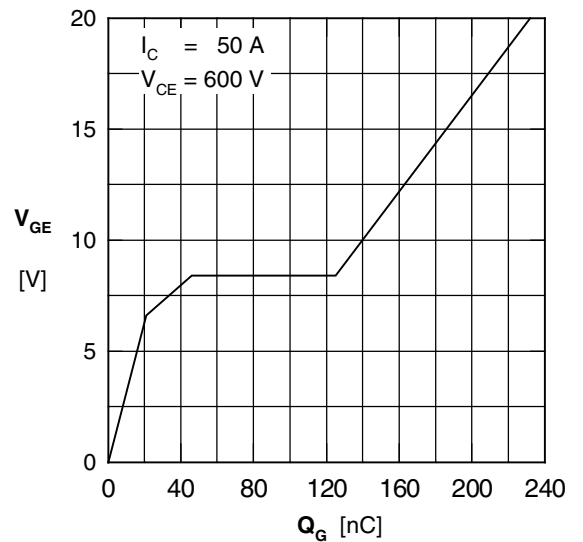

Fig. 4 Typ. turn-on gate charge

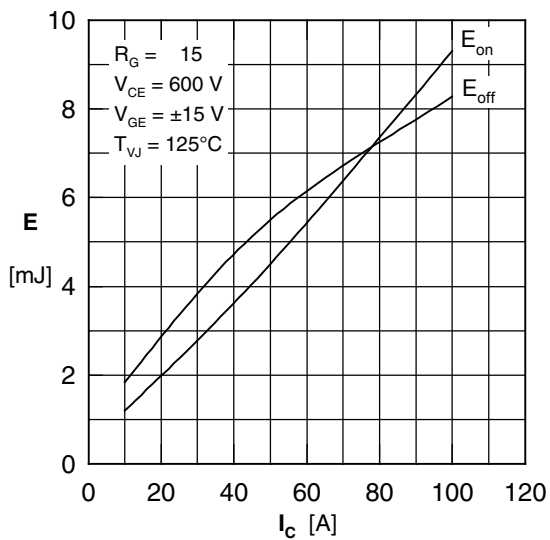

Fig. 5 Typ. switching energy vs. collector current

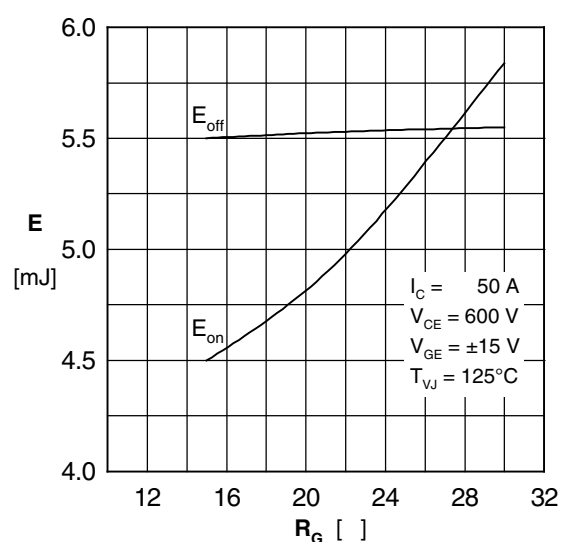

Fig. 6 Typ. switching energy vs. gate resistance

## Diode

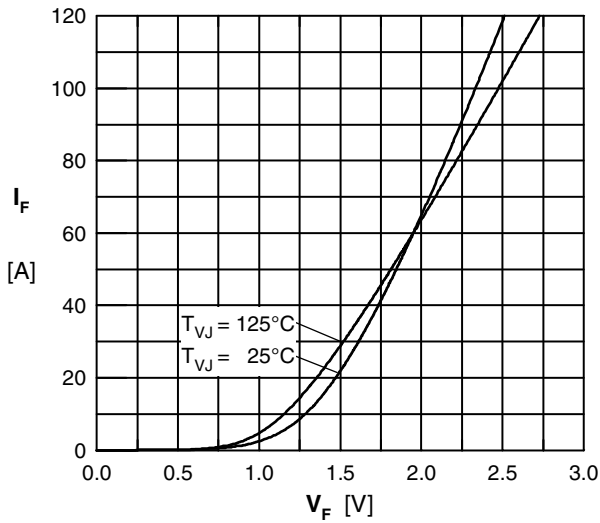

Fig. 7 Typ. Forward current versus  $V_F$

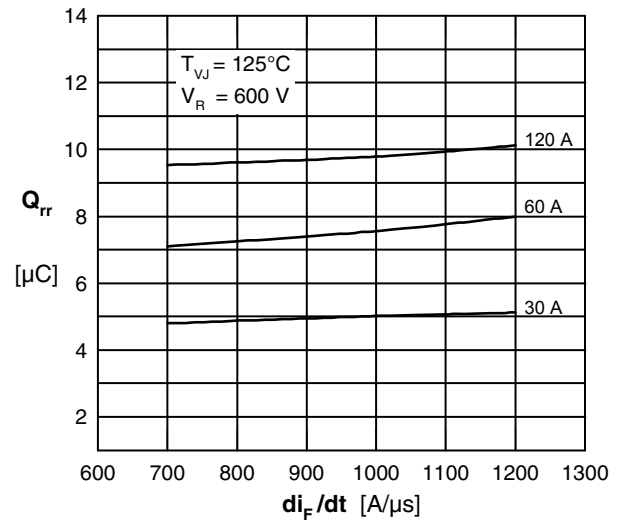

Fig. 8 Typ. reverse recov. charge  $Q_{rr}$  vs.  $di/dt$

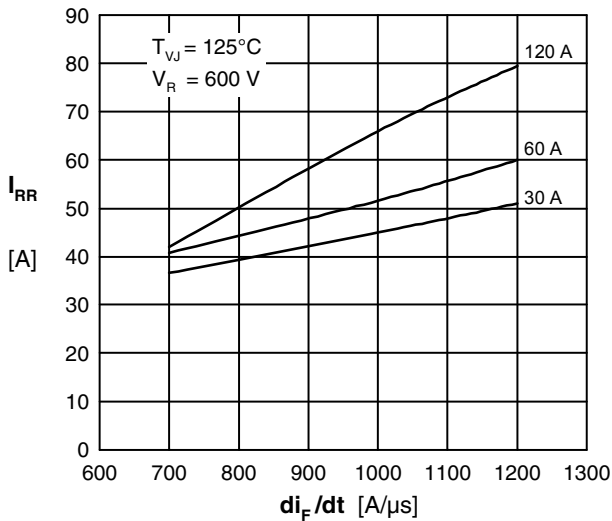

Fig. 9 Typ. peak reverse current  $I_{RM}$  vs.  $di/dt$

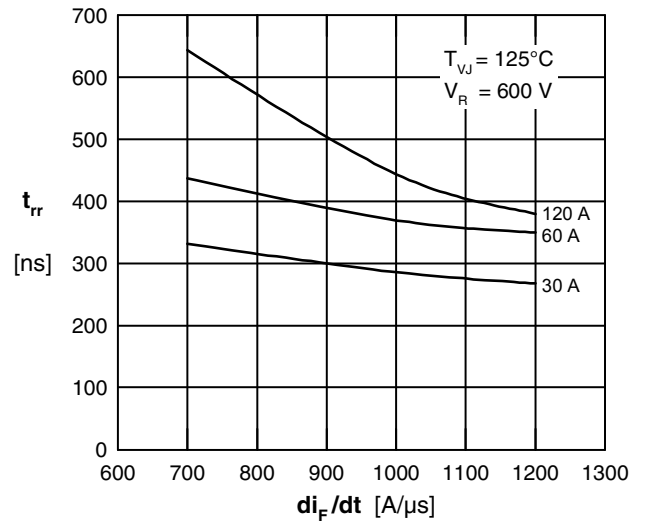

Fig. 10 Typ. recovery time  $t_{rr}$  versus  $di/dt$

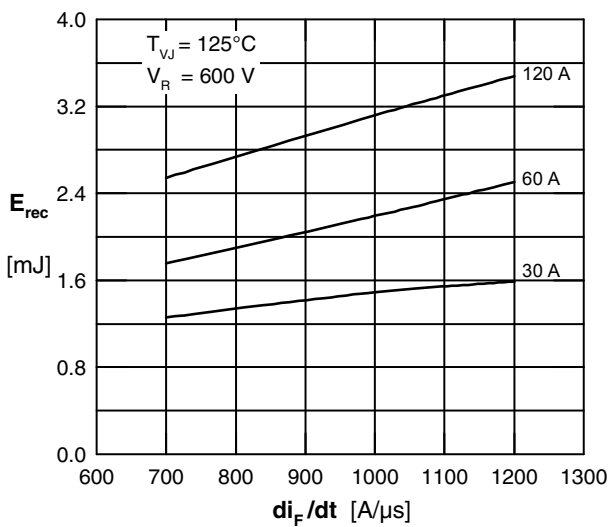

Fig. 11 Typ. recovery energy  $E_{rec}$  versus  $di/dt$

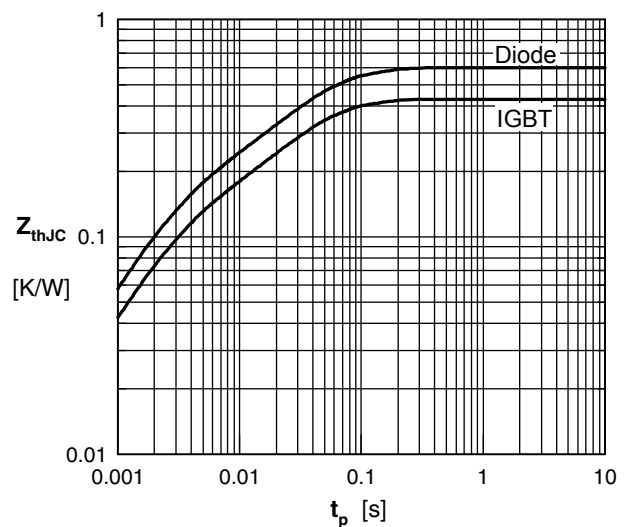

Fig. 12 Typ. transient thermal impedance



---

Disclaimer Notice - Information furnished is believed to be accurate and reliable. However, users should independently evaluate the suitability of and test each product selected for their own applications. Littelfuse products are not designed for, and may not be used in, all applications. Read complete Disclaimer Notice at [www.littelfuse.com/disclaimer-electronics](http://www.littelfuse.com/disclaimer-electronics).

单击下面可查看定价，库存，交付和生命周期等信息

[>>Littelfuse\(美国力特\)](#)