

SP4203 0.5 pF, 10A bidirectional discrete TVS diodes



Description

The SP4203 integrates low capacitance diodes to provide electronic equipment protection from destructive electrostatic discharges (ESDs). These robust TVSs can withstand repetitive contact or air ESD discharge events at ± 30 kV levels without suffering any performance degradation. This exceeds the ESD contact and air discharge test requirements of IEC 61000-4-2. Additionally, the TVS can withstand an 8/20 surge current event as defined in IEC 61000-4-5 2nd edition up to 10A and still provide low voltage clamping levels.

Pinout



Features

- ESD, IEC 61000-4-2, ± 30 kV contact, ± 30 kV air
- EFT, IEC 61000-4-4, 40A (5/50ns)
- Lightning, 10A (8/20 as defined in IEC 61000-4-5 2nd edition)
- Low capacitance of 0.5pF (@ $V_R=0V$)
- Low leakage current
- Small SOD323 package fits 0805 footprints
- AEC-Q101 qualified
- Halogen free, lead free and RoHS compliant
- Moisture Sensitivity Level (MSL -1)

Functional Block Diagram



Applications

- xDSL Interfaces
- RS-232
- RS-485
- Power Ports
- Security Equipment
- Instrumentation
- Medical Equipment
- Computers and Peripherals

Life Support Note:

Not Intended for Use in Life Support or Life Saving Applications

The products shown herein are not designed for use in life sustaining or life saving applications unless otherwise expressly indicated.

Absolute Maximum Ratings

Symbol	Parameter	Value	Units
I_{PP}	Peak Current ($t_p=8/20\mu s$)	10	A
T_{OP}	Operating Temperature	-40 to 125	°C
T_{STOR}	Storage Temperature	-55 to 150	°C

Notes:

CAUTION: Stresses above those listed in "Absolute Maximum Ratings" may cause permanent damage to the component. This is a stress only rating and operation of the component at these or any other conditions above those indicated in the operational sections of this specification is not implied.

Electrical Characteristics ($T_{OP}=25^\circ C$)

Parameter	Symbol	Test Conditions	Min	Typ	Max	Units
Reverse Standoff Voltage	V_{RWM}	$I_R=1\mu A$			3.3	V
Breakdown Voltage	V_{BR}	$I_R=1mA$	5.5	6.6		V
Reverse Leakage Current	I_{LEAK}	$V_R=3.3V$			0.1	μA
Clamp Voltage ¹	V_C	$I_{PP}=1A, t_p=8/20\mu s$		7.5	10	V
		$I_{PP}=10A, t_p=8/20\mu s$		16.5	20	V
Dynamic Resistance ²	R_{DYN}	TLP, $t_p=100ns$, I/O to I/O		0.54		Ω
ESD Withstand Voltage ¹	V_{ESD}	IEC 61000-4-2 (Contact Discharge)	± 30			kV
		IEC 61000-4-2 (Air Discharge)	± 30			kV
Diode Capacitance ¹	$C_{I/O-I/O}$	Reverse Bias=0V, $f=1MHz$		0.5	0.9	pF

Notes:

1.Parameter is guaranteed by design and/or component characterization.

2.Transmission Line Pulse (TLP) with 100ns width, 2ns rise time, and average window $t_1=70ns$ to $t_2=90ns$

8/20 μs Pulse Waveform

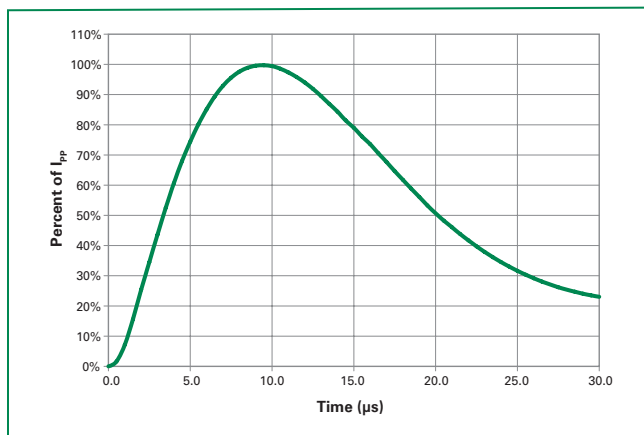

Capacitance vs. Reverse Bias

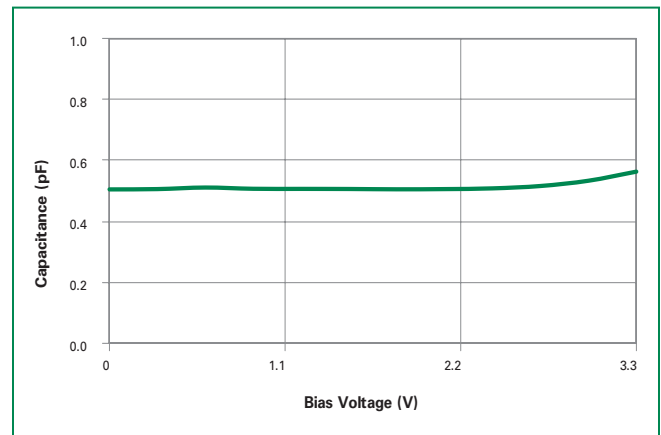

Positive Transmission Line Pulsing (TLP) Plot

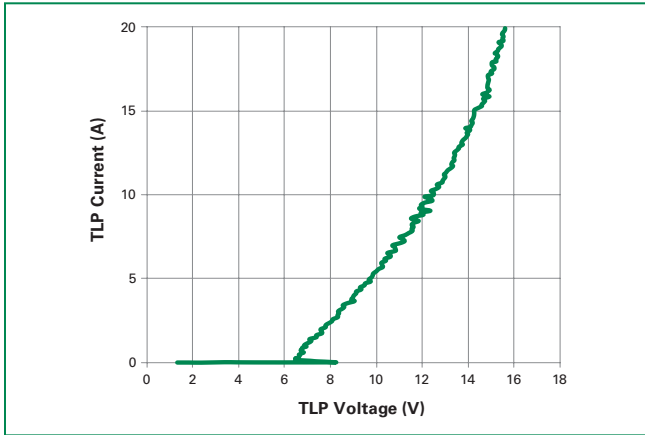

Negative Transmission Line Pulsing (TLP) Plot

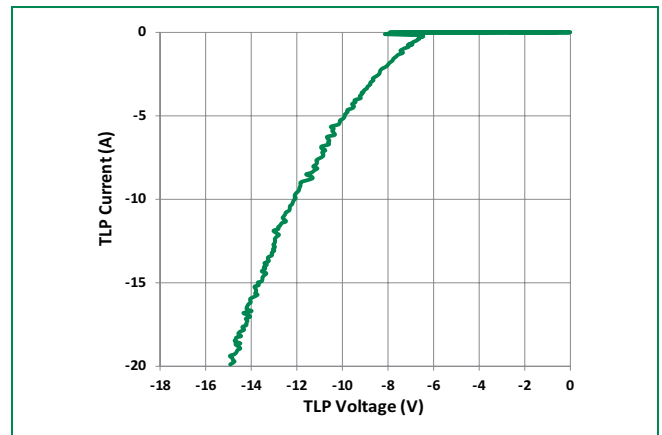

IEC 61000-4-2 +8kV Contact ESD Clamping Voltage

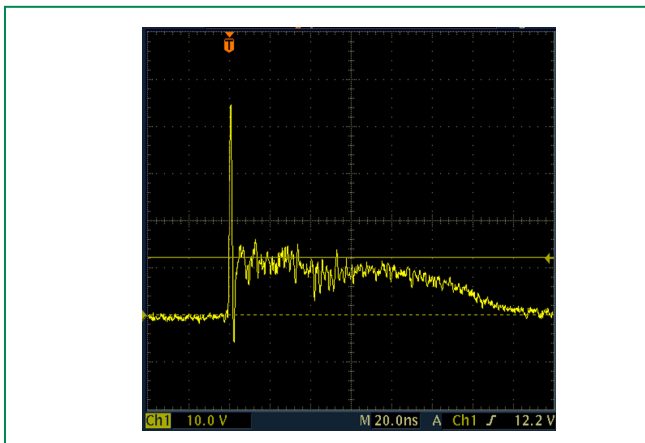

IEC 61000-4-2 -8kV Contact ESD Clamping Voltage

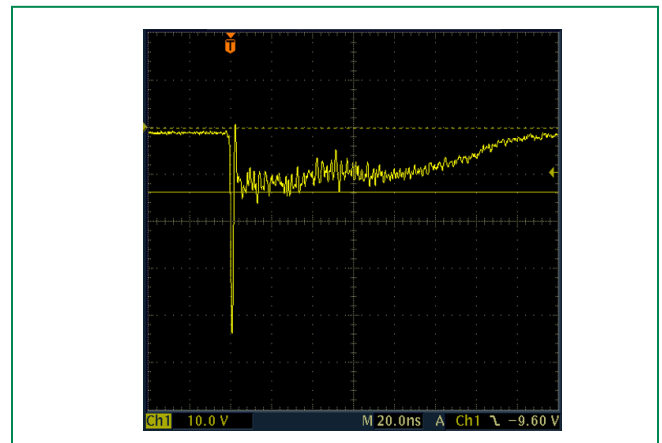

Clamping voltage vs. I_{pp} for 8/20 μ s waveshape

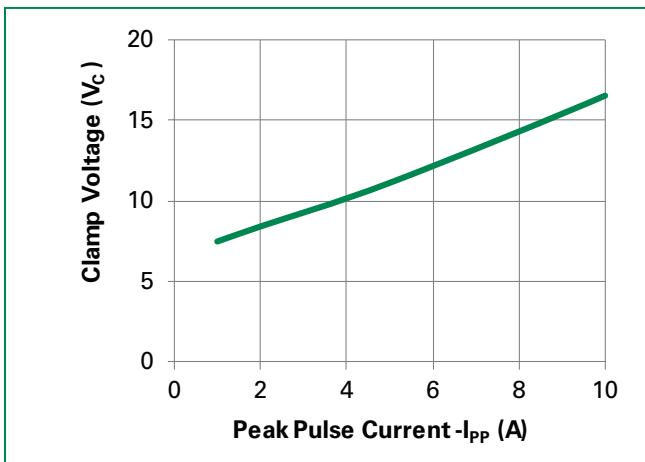

Soldering Parameters

Reflow Condition		Pb – Free assembly
Pre Heat	- Temperature Min ($T_{s(min)}$)	150°C
	- Temperature Max ($T_{s(max)}$)	200°C
	- Time (min to max) (t_s)	60 – 180 secs
Average ramp up rate (Liquidus) Temp (T_L) to peak		3°C/second max
$T_{s(max)}$ to T_L - Ramp-up Rate		3°C/second max
Reflow	- Temperature (T_L) (Liquidus)	217°C
	- Temperature (t_L)	60 – 150 seconds
Peak Temperature (T_p)		260 ^{+0/-5} °C
Time within 5°C of actual peak Temperature (t_p)		20 – 40 seconds
Ramp-down Rate		6°C/second max
Time 25°C to peak Temperature (T_p)		8 minutes Max.
Do not exceed		260°C

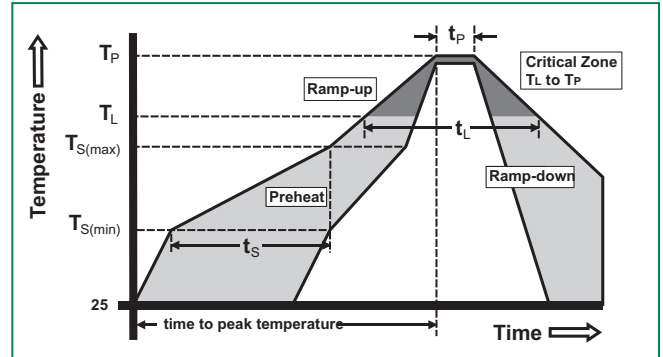

Product Characteristics

Lead Plating	Matte Tin
Lead Material	Alloy 42
Lead Coplanarity	0.004 inches(0.102mm)
Substrate Material	Silicon
Body Material	Molded Compound
Flammability	UL Recognized compound meeting flammability rating V-0

Part Marking System

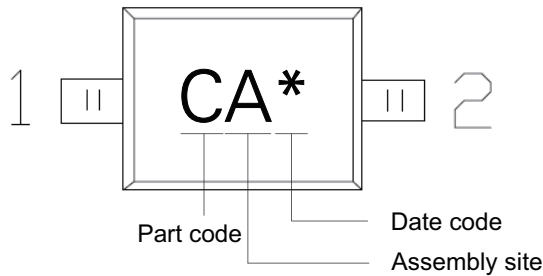

Part Numbering System

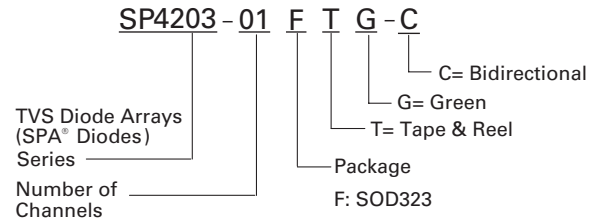

Ordering Information

Part Number	Package	Min. Order Qty.
SP4203-01FTG-C	SOD323	3000

Package Dimensions -SOD323

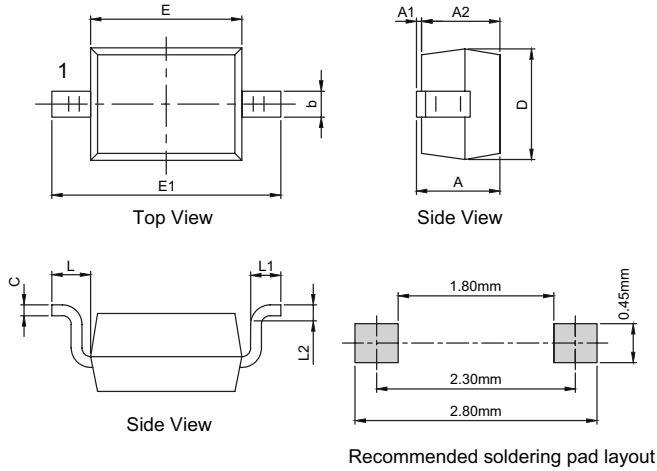

Drawing#: F03-A

Symbol	SOD323			
	Millimeters		Inches	
	Min	Max	Min	Max
A	-	1.00	-	0.039
A1	0.00	0.10	0.000	0.004
A2	0.80	0.90	0.031	0.035
b	0.25	0.35	0.010	0.014
c	0.08	0.15	0.003	0.006
D	1.20	1.40	0.047	0.055
E	1.60	1.90	0.063	0.075
E1	2.50	2.70	0.098	0.106
L	0.475 REF		0.019 REF	
L1	0.25	0.40	0.010	0.016
L2	0.20 BSC		0.008 BSC	

Embossed Carrier Tape & Reel Specification – SOD323

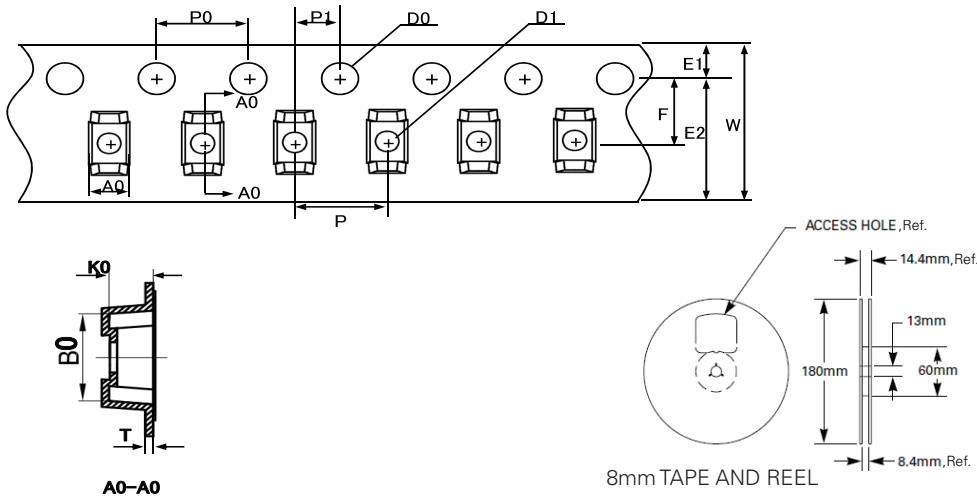

Symbol	Millimeters
A0	1.46+/-0.10
B0	2.90+/-0.10
W	8.0+0.3/-0.10
D0	1.50+0.10
D1	0.45min/1.15max
E1	1.75+/-0.10
E2	-
F	3.50+/-0.10
P0	4.00+/-0.10
P	4.00+/-0.10
P1	2.00+/-0.05
K0	1.25+/-0.10
T	0.254+/-0.02

Disclaimer Notice - Information furnished is believed to be accurate and reliable. However, users should independently evaluate the suitability of and test each product selected for their own applications. Littelfuse products are not designed for, and may not be used in, all applications. Read complete Disclaimer Notice at <http://www.littelfuse.com/disclaimer-electronics>.

单击下面可查看定价，库存，交付和生命周期等信息

[>>Littelfuse\(美国力特\)](#)