

FlexMod™ SMART BATTERY ISOLATOR CONTROLLER



Description

Preserves starting battery voltage by isolating the auxiliary battery when system voltage drops. For vehicles with two batteries (or banks of batteries). Turns any electromechanical solenoid or relay into a Smart Isolator.

Features and Benefits

- Isolates main and auxiliary batteries when system voltage drops below 12.7V, and automatically reconnects battery banks at 13.2V. Preserves starting power; eliminates downtime and jump starts due to dead batteries.
- Start assist feature provides boost to starting battery, when needed.
- Compatible with modern electronically controlled alternators (some diode Battery Isolators are not). Smart Battery Isolator Controller eliminates false battery warnings created by diode isolators.
- Status light output drives remote light, informing operator when banks are connected.
- Auto-ranging to automatically sense the voltage of the system (12 or 24V) and selects the presets appropriate to that voltage.
- Waterproof, dustproof and vibration-proof. Sealed to IP67 so it can mount on a vehicle even in places where road-splash is a problem.
- Ultra low 1mA standby current means minimal battery drain – especially valuable when vehicle is in storage or not in use.
- Factory programmable unit is highly versatile: with a broad range of presets available to match any special application.
- Rated for more than 1,000,000 on-off cycles – unit operates for the lifetime of the vehicle. Solid state technology gives long life and low maintenance.
- Compact design (4 x 3 x 1") – Uses less space; mounts outside or inside. Saves money by eliminating other hardware, and provides better wire routing.

Specifications Overview

Voltage Rating:	12-24V DC (Auto Ranging)
Humidity:	0 to 90%RH
Vibration:	10-500Hz
Operating Temp:	-40° to +85°C
Ingress Protection:	IP67
Dimensions:	4.0" x 2.70" x 1.31"

Web Resources

Download technical resources at:
littelfuse.com/FlexMod

Ordering Information

PART NUMBERS		DESCRIPTION	HARNESS INCLUDED
BULK	BOXED		
48540	48540-BX	Unit Only	No
-	48540-01-BX	Unit & Harness	Yes
48740	-	Dealer-programmable unit	No
-	48740-01-BX	Dealer-programmable unit w/ Harness	Yes

Accessories

PART NUMBERS	DESCRIPTION
12805	FlexMod Harness



FlexMod™ Dimensions

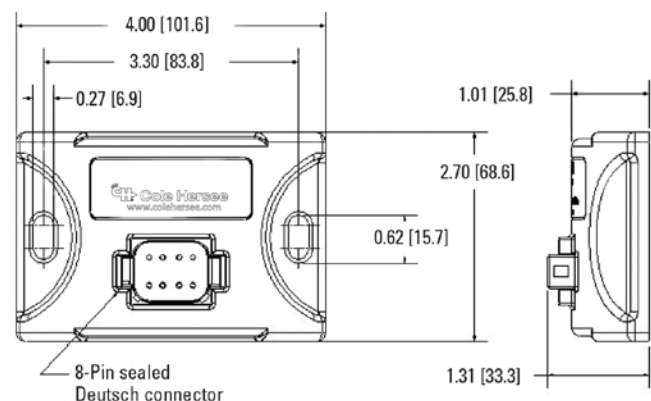

Datasheet Replaces Hotfeed Number D-632

FlexMod™ SMART BATTERY ISOLATOR CONTROLLER

Electrical Characteristics

CHARACTERISTIC	MIN	TYPICAL	MAX	NOTES
Operating voltage (12V)	9V	12V	32V	Operating voltage is the system voltage
Disconnect voltage (12V 24V)		12.7 25.4		When voltage drops below 12.7V (25.4V), for 1 minute, the isolator disconnects the solenoid/relay.
Connect voltage (12V 24V)		13.2 26.4		When either of the battery banks rises above 13.2V (26.4V) for 2 minutes, the isolator connects the solenoid/relay.
Quiescent Current		1mA	2mA	Circuit operating current
Load Current			10A at 85°C	
Overcurrent Protection		15A		System will disconnect after 1 second of excessive current
Status light load			200mA	High side LED circuit

Environmental Specifications

CHARACTERISTIC	PARAMETER	NOTES
Operating Temperature Range	-40° to +85°C -40° to +185°F	10A at 85°C
Ingress Protection	IP67	Per IEC 529
Humidity	0 to 90%RH	
Vibration	10-500Hz	Per SAE J1455
Shock		Per SAE J1455
Thermal Shock		Per SAE J1455
Inductive Transient	+/- 600V	Per SAE J1455
Load Dump	+150V	Per SAE J1455

Installation Configuration

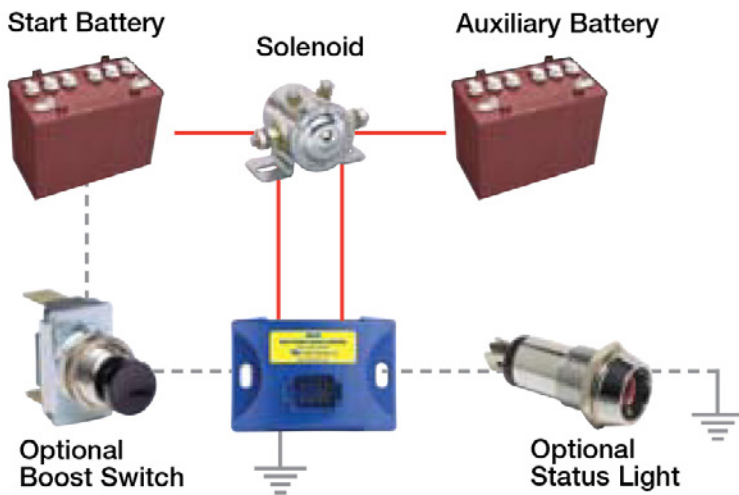

Visit Littelfuse.com for the most up-to-date product information. Littelfuse products are designed for specific applications and should not be used for any purpose (including, without limitation, automotive applications) not expressly set forth in applicable Littelfuse product documentation. Warranties granted by Littelfuse shall be deemed void for products used for any purpose not expressly set forth in applicable Littelfuse product documentation. Littelfuse shall not be liable for any claims or damages arising out of products used in applications not expressly intended by Littelfuse as set forth in applicable Littelfuse product documentation.

THE FlexMod™ FAMILY OF PRODUCTS

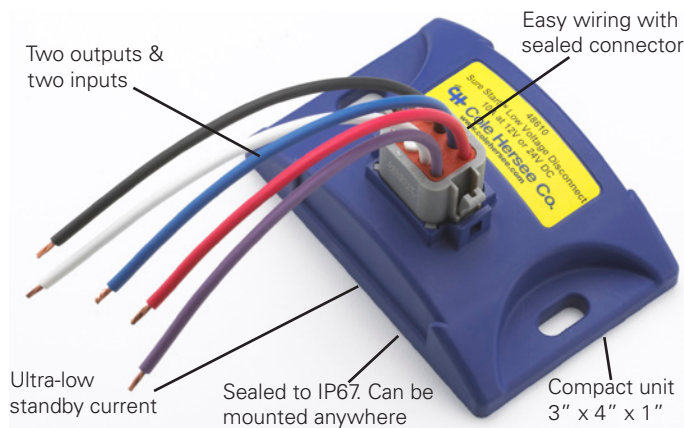

The FlexMod™ family is a series of small, robust electronic modules. They have two inputs (one analog and one digital) and two solid state outputs (one 10A, one 200mA) that can be programmed to do almost any job.

We have created some standard units (see below) to meet specific application needs.

- Simple wiring, accepts snap-in standard sealed connector – unit is easy to install. Part number with -01 suffix includes wiring harness.
- FlexMod is auto-ranging – automatically senses the voltage of the system (12 or 24V) and selects the presets appropriate to that voltage. Single unit means less stock and fewer SKUs.
- Ultra low 1mA standby current means minimal battery drain – especially valuable when vehicle is in storage or not in use.
- Factory programmable unit is highly versatile: with a broad range of presets available to match any special application.
- Rated for more than 1,000,000 on-off cycles – unit operates for the lifetime of the vehicle. Solid state technology gives long life and low maintenance.
- Provides overvoltage and overcurrent protection to every direct load in that circuit– gives extra levels of protection.
- Small lightweight sealed design – Uses less space; mounts outside or inside. Saves money by eliminating other hardware, and provides better wire routing..

48540 Smart Battery Isolator Controller

The FlexMod unit monitors two battery banks and controls one or more relays or contactors to make sure starting power is protected by isolating the starting and auxiliary battery banks. Part number 48740 is dealer-programmable.

48610 Low Voltage Disconnect

The FlexMod unit preserves battery charge and protects battery banks by automatically disconnecting loads when battery voltage drops to a critical level. Part number 48710 is dealer-programmable.

48636 Lighting Timer

The FlexMod unit prevents the internal lights inside a trailer from being left on and draining the battery. Vehicle operator operates a momentary switch which turns lights on, allowing safe operation inside the cargo compartment. After 20 minutes the FlexMod flashes the lights and gives the operator increasingly urgent warnings to either exit the cargo compartment or reactivate the timer before the lights go out. Part number 48736 is dealer-programmable.

48541 Electronic Voltage Sensing Relay & Timer

The FlexMod unit monitors both battery voltage and ignition status, shutting down non-critical loads when the cutoff voltage is reached, or at the set time after the ignition is turned off. It is a timer and voltage sensor in one easy-to-connect unit. Part number 48741 is dealer-programmable.

Dealer Programming Of Units

FlexMod is a highly versatile unit that can be programmed by dealers, and can be tailored to the specific applications of customers. Parameters such as time, voltage, and current limits are easy to customize, using straightforward on-screen options.

Our programming unit plugs into your computer, and to a FlexMod, which can be programmed within minutes. The system has the advantage of accessing the FlexMod via the integral sealed connector. Unlike competitive products, it is not an invasive process which compromises the waterproof integrity of the unit.

Contact Littelfuse or one of our official dealers about programmable products.

DEALER NAME	LOCATION	PHONE NUMBER
Bert Block Associates	Grand Rapids, MI	+1 616-538-9419
Diesel Equipment	Greensboro, NC	+1 800-222-7159
Marsh Electronics	Milwaukee, WI	+1 800-926-2774
J & N	Cincinnati, OH	+1 800-366-7100
ASE Supply	Portland, OR	+1 503-288-4866
IJ Walsh	London, UK	+44 1227 769784

COMMON FlexMod™ APPLICATIONS

Littlefuse designed these units to solve problems in many industries. Here are a few of the thousands of potential applications. Contact us with your specific application requirements.

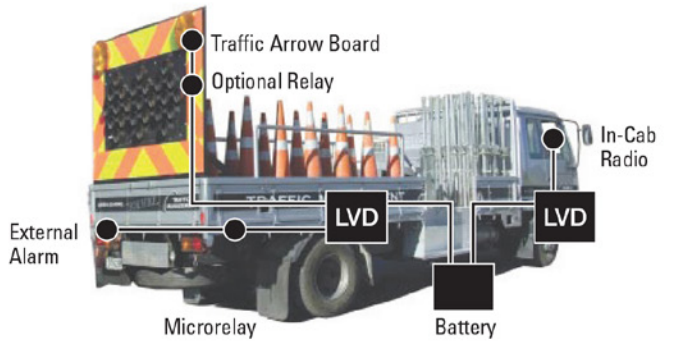

Typical Application 1 Idle reduction for work vehicles

Use the 48610 FlexMod LVD to protect starting power, and save fuel (and fines!) by eliminating idling. By connecting safety signboard (or other loads) to the LVD, the signboard can be safely run with the engine off, without the risk of a dead battery. By connecting the horn or external alarm to the alarm circuit, the vehicle operator will be warned of impending shutdown.

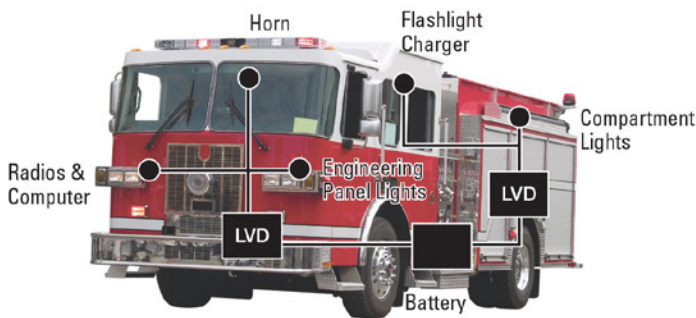

Typical Application 2 NFPA 1901 Load Manager compliance for fire vehicles

Program the 48710 FlexMod LVD to combine low voltage warning and/or single circuit load management in one unit. A second 48710 FlexMod LVD can manage other loads, and if mounted close to the loads, will minimize wiring runs.

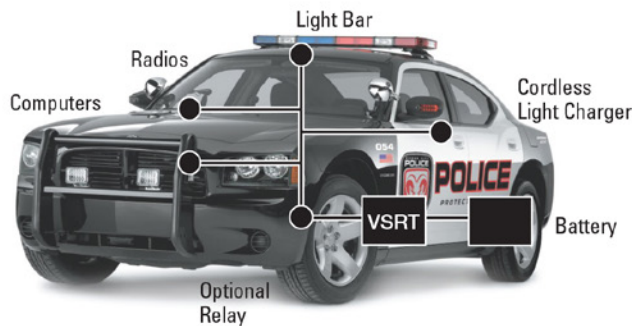

Typical Application 3 Combined timer/voltage shutoff for police vehicles

48541 FlexMod VSRT combines two functions (time and voltage) in one small unit that opens up options for mounting in a small space, and simplifies wiring and other components. The FlexMod VSRT protects starting power with simultaneous sensing of time and voltage.

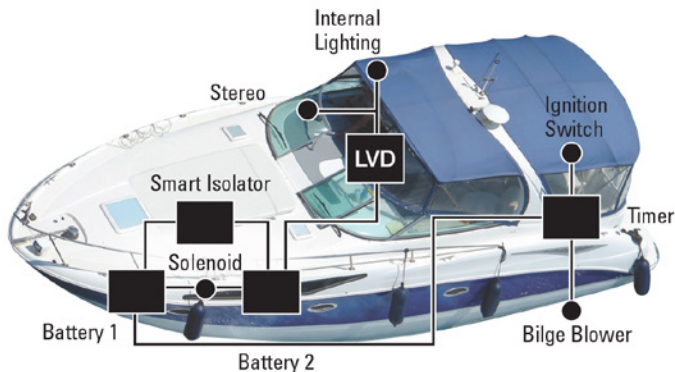

Typical Application 4 Smart charging system for boats

The 48540 FlexMod Smart Isolator Controller turns an existing solenoid charging system into a smart system. The FlexMod protects the alternator with priority charging, and allows shore power connected to the house battery to charge the starting battery as well! The 48610 protects batteries from damage.

单击下面可查看定价，库存，交付和生命周期等信息

[>>Littelfuse\(美国力特\)](#)