

# PolarHT™ Power MOSFET

**IXTQ69N30P**  
**IXTT69N30P**

$V_{DSS} = 300 \text{ V}$   
 $I_{D25} = 69 \text{ A}$   
 $R_{DS(on)} \leq 49 \text{ m}\Omega$

N-Channel Enhancement Mode  
Avalanche Rated



Symbol	Test Conditions	Maximum Ratings	
$V_{DSS}$	$T_J = 25^\circ\text{C to } 150^\circ\text{C}$	300	V
$V_{DGR}$	$T_J = 25^\circ\text{C to } 150^\circ\text{C}; R_{GS} = 1 \text{ M}\Omega$	300	V
$V_{GSS}$	Continuous	$\pm 20$	V
$V_{GSM}$	Transient	$\pm 30$	V
$I_{D25}$	$T_C = 25^\circ\text{C}$	69	A
$I_{DM}$	$T_C = 25^\circ\text{C}$ , pulse width limited by $T_{JM}$	200	A
$I_{AR}$	$T_C = 25^\circ\text{C}$	69	A
$E_{AR}$	$T_C = 25^\circ\text{C}$	50	mJ
$E_{AS}$	$T_C = 25^\circ\text{C}$	1.5	J
$dv/dt$	$I_S \leq I_{DM}$ , $di/dt \leq 100 \text{ A}/\mu\text{s}$ , $V_{DD} \leq V_{DSS}$ , $T_J \leq 150^\circ\text{C}$ , $R_G = 4 \Omega$	10	V/ns
$P_D$	$T_C = 25^\circ\text{C}$	500	W
$T_J$		-55 ... +150	$^\circ\text{C}$
$T_{JM}$		150	$^\circ\text{C}$
$T_{stg}$		-55 ... +150	$^\circ\text{C}$
$T_L$	1.6 mm (0.062 in.) from case for 10 s	300	$^\circ\text{C}$
$T_{SOLD}$	Plastic body for 10 s	260	$^\circ\text{C}$
$M_d$	Mounting torque (TO-3P)	1.13/10	Nm/lb.in.
Weight	TO-3P	5.5	g
	TO-268	5.0	g

TO-3P (IXTQ)



TO-268 (IXTT)

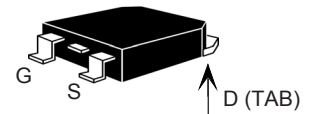

G = Gate      D = Drain  
S = Source    TAB = Drain

### Features

- † International standard packages
- † Unclamped Inductive Switching (UIS) rated
- † Low package inductance  
- easy to drive and to protect

### Advantages

- † Easy to mount
- † Space savings
- † High power density

Symbol	Test Conditions ( $T_J = 25^\circ\text{C}$ , unless otherwise specified)	Characteristic Values		
		Min.	Typ.	Max.
$BV_{DSS}$	$V_{GS} = 0 \text{ V}$ , $I_D = 250 \mu\text{A}$	300		V
$V_{GS(th)}$	$V_{DS} = V_{GS}$ , $I_D = 250 \mu\text{A}$	2.5		5.0 V
$I_{GSS}$	$V_{GS} = \pm 20 \text{ V}_{DC}$ , $V_{DS} = 0$			$\pm 100 \text{ nA}$
$I_{DSS}$	$V_{DS} = V_{DSS}$ $V_{GS} = 0 \text{ V}$ $T_J = 125^\circ\text{C}$			25 $\mu\text{A}$
				250 $\mu\text{A}$
$R_{DS(on)}$	$V_{GS} = 10 \text{ V}$ , $I_D = 0.5 I_{D25}$ Pulse test, $t \leq 300 \mu\text{s}$ , duty cycle $d \leq 2\%$			49 $\text{m}\Omega$

Symbol	Test Conditions	Characteristic Values		
		(T <sub>J</sub> = 25° C, unless otherwise specified)		
		Min.	Typ.	Max.
<b>g<sub>fs</sub></b>	V <sub>DS</sub> = 10 V; I <sub>D</sub> = 0.5 I <sub>D25</sub> , pulse test	30	48	S
<b>C<sub>iss</sub></b>	V <sub>GS</sub> = 0 V, V <sub>DS</sub> = 25 V, f = 1 MHz		4960	pF
<b>C<sub>oss</sub></b>			760	pF
<b>C<sub>rss</sub></b>			190	pF
<b>t<sub>d(on)</sub></b>	V <sub>GS</sub> = 10 V, V <sub>DS</sub> = 0.5 V <sub>DSS</sub> , I <sub>D</sub> = I <sub>D25</sub> R <sub>G</sub> = 4 Ω (External)		25	ns
<b>t<sub>r</sub></b>			25	ns
<b>t<sub>d(off)</sub></b>			75	ns
<b>t<sub>f</sub></b>			27	ns
<b>Q<sub>g(on)</sub></b>	V <sub>GS</sub> = 10 V, V <sub>DS</sub> = 0.5 V <sub>DSS</sub> , I <sub>D</sub> = 0.5 I <sub>D25</sub>		156	180 nC
<b>Q<sub>gs</sub></b>			32	nC
<b>Q<sub>gd</sub></b>			79	nC
<b>R<sub>thJC</sub></b>	(TO-3P)			0.25° C/W
<b>R<sub>thCS</sub></b>			0.21	° C/W

Symbol	Test Conditions	Characteristic Values		
		(T <sub>J</sub> = 25° C, unless otherwise specified)		
		Min.	Typ.	Max.
<b>I<sub>s</sub></b>	V <sub>GS</sub> = 0 V			69 A
<b>I<sub>SM</sub></b>	Repetitive			200 A
<b>V<sub>SD</sub></b>	I <sub>F</sub> = I <sub>S</sub> , V <sub>GS</sub> = 0 V, Pulse test, t ≤ 300 μs, duty cycle d ≤ 2 %			1.5 V
<b>T<sub>rr</sub></b>	I <sub>F</sub> = 25 A, -di/dt = 100 A/μs V <sub>R</sub> = 100 V, V <sub>GS</sub> = 0V		250	ns
<b>Q<sub>RM</sub></b>			3.0	μC

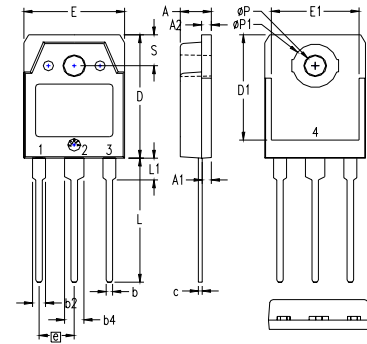
**TO-3P (IXTQ) Outline**

- 1 - GATE
- 2 - DRAIN (COLLECTOR)
- 3 - SOURCE (EMITTER)
- 4 - DRAIN (COLLECTOR)

SYM	INCHES		MILLIMETERS	
	MIN	MAX	MIN	MAX
A	.185	.193	4.70	4.90
A1	.051	.059	1.30	1.50
A2	.057	.065	1.45	1.65
b	.035	.045	0.90	1.15
b2	.075	.087	1.90	2.20
b4	.114	.126	2.90	3.20
c	.022	.031	0.55	0.80
D	.780	.799	19.80	20.30
D1	.665	.677	16.90	17.20
E	.610	.622	15.50	15.80
E1	.531	.539	13.50	13.70
e	.215 BSC		5.45 BSC	
L	.779	.795	19.80	20.20
L1	.134	.142	3.40	3.60
øP	.126	.134	3.20	3.40
øP1	.272	.280	6.90	7.10
S	.193	.201	4.90	5.10

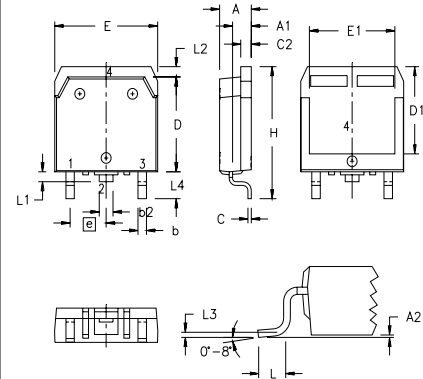
**TO-268 (IXTT) Outline**

SYM	INCHES		MILLIMETERS	
	MIN	MAX	MIN	MAX
A	.193	.201	4.90	5.10
A1	.106	.114	2.70	2.90
A2	.001	.010	0.02	0.25
b	.045	.057	1.15	1.45
b2	.075	.083	1.90	2.10
C	.016	.026	0.40	0.65
C2	.057	.063	1.45	1.60
D	.543	.551	13.80	14.00
D1	.488	.500	12.40	12.70
E	.624	.632	15.85	16.05
E1	.524	.535	13.30	13.60
e	.215 BSC		5.45 BSC	
H	.736	.752	18.70	19.10
L	.094	.106	2.40	2.70
L1	.047	.055	1.20	1.40
L2	.039	.045	1.00	1.15
L3	.010 BSC		0.25 BSC	
L4	.150	.161	3.80	4.10

IXYS reserves the right to change limits, test conditions, and dimensions.

IXYS MOSFETs and IGBTs are covered by	4,835,592	4,931,844	5,049,961	5,237,481	6,162,665	6,404,065 B1	6,683,344	6,727,585
one or more of the following U.S. patents:	4,850,072	5,017,508	5,063,307	5,381,025	6,259,123 B1	6,534,343	6,710,405B2	6,759,692
	4,881,106	5,034,796	5,187,117	5,486,715	6,306,728 B1	6,583,505	6,710,463	6,771,478 B2

**Fig. 1. Output Characteristics @ 25 Deg. C**

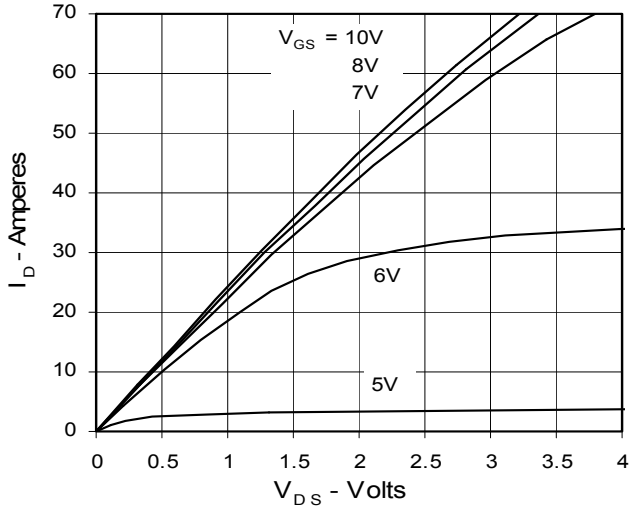

**Fig. 2. Extended Output Characteristics @ 25 deg. C**

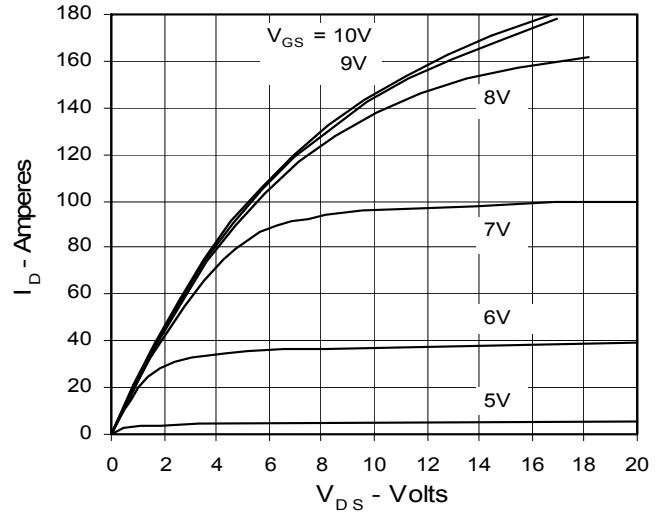

**Fig. 3. Output Characteristics @ 125 Deg. C**

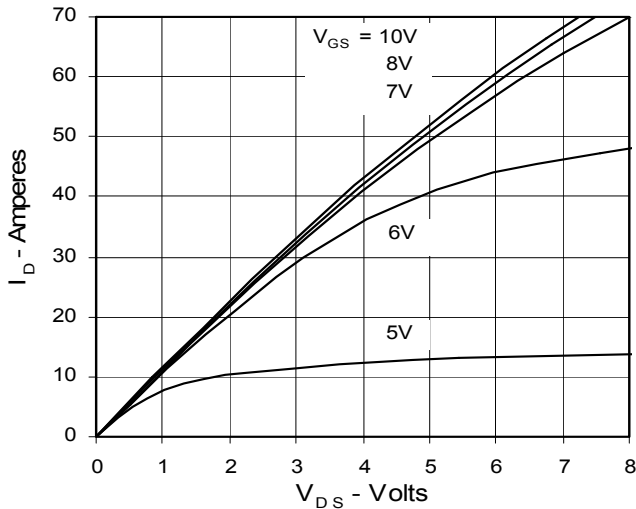

**Fig. 4.  $R_{DS(on)}$  Normalized to  $I_{D25}$  Value vs. Junction Temperature**

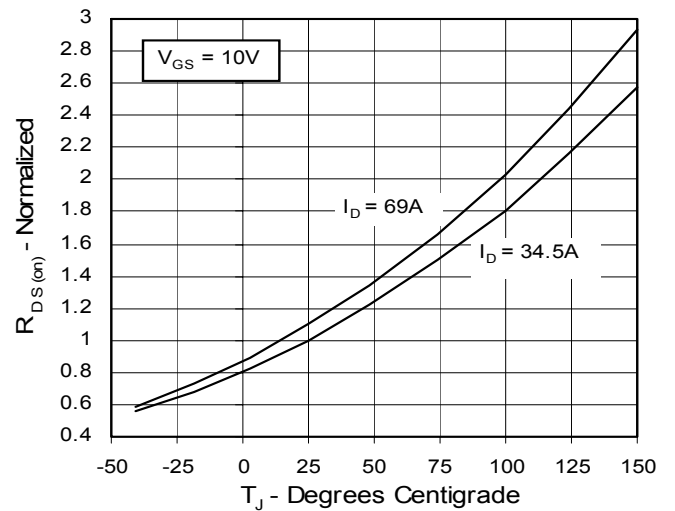

**Fig. 5.  $R_{DS(on)}$  Normalized to  $I_{D25}$  Value vs.  $I_D$**

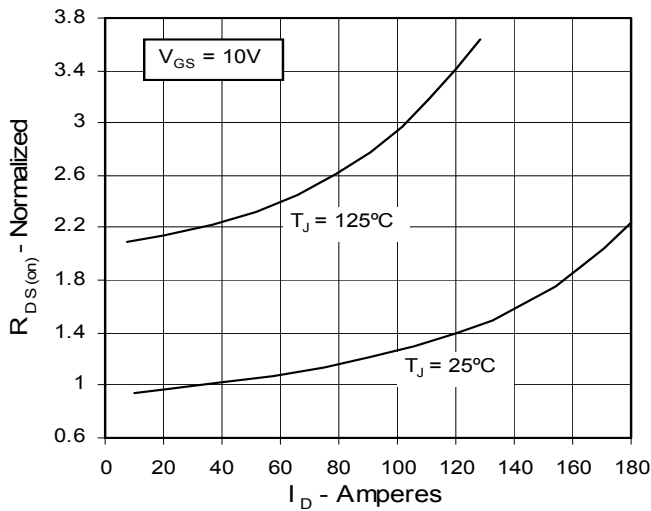

**Fig. 6. Drain Current vs. Case Temperature**

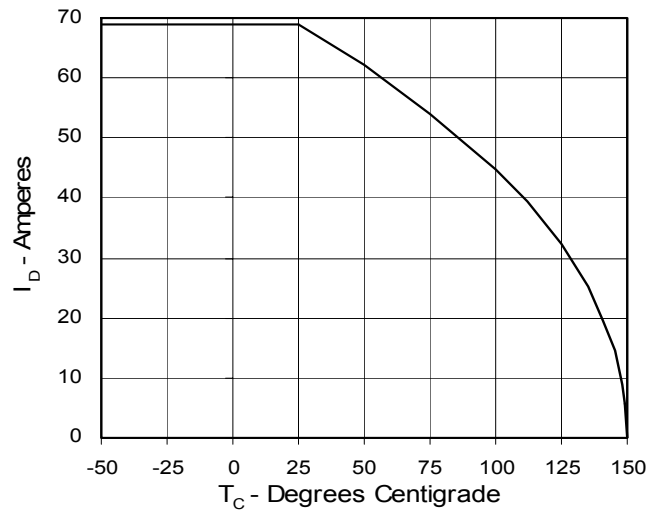

**Fig. 7. Input Admittance**

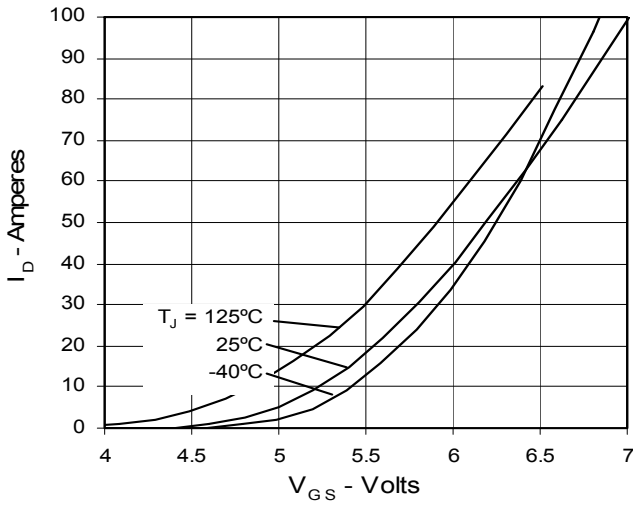

**Fig. 8. Transconductance**

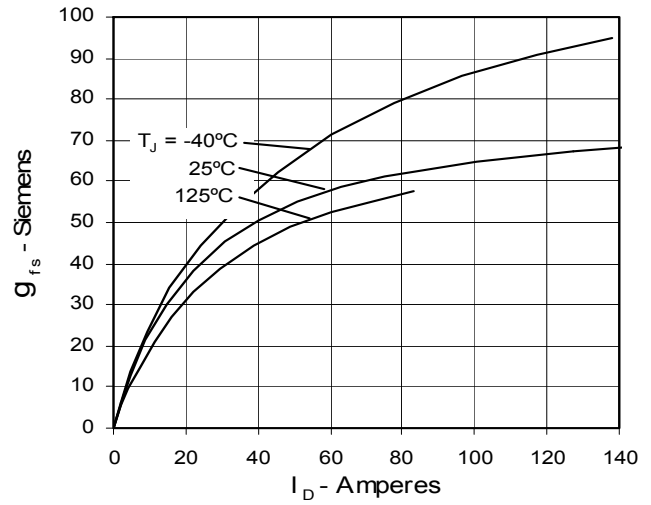

**Fig. 9. Source Current vs. Source-To-Drain Voltage**

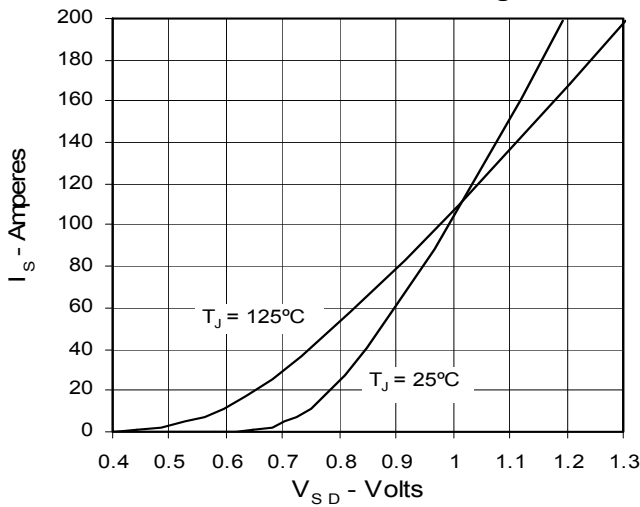

**Fig. 10. Gate Charge**

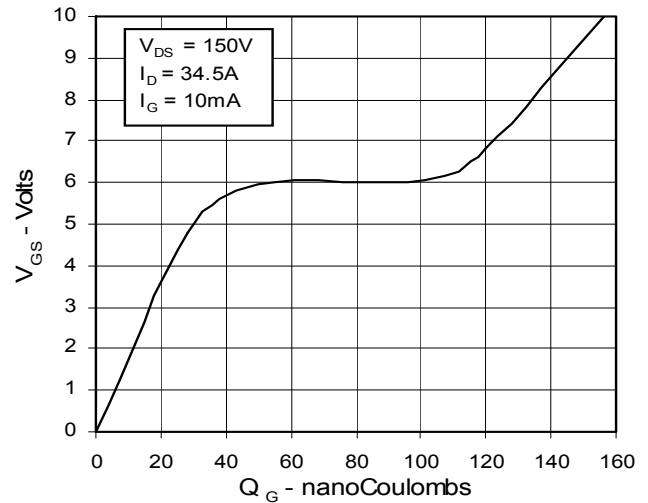

**Fig. 11. Capacitance**

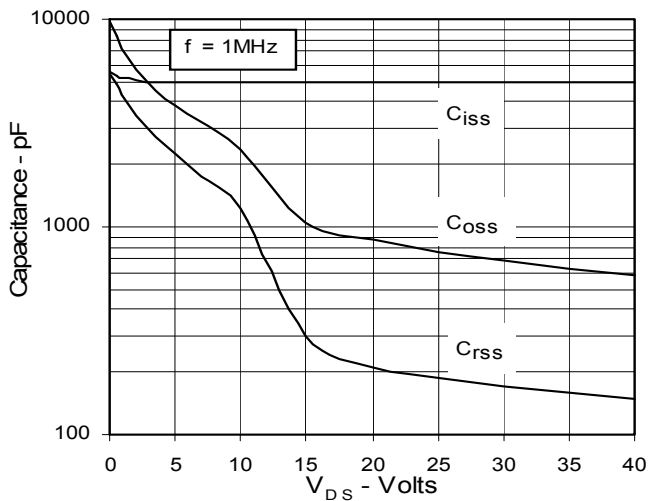

**Fig. 12. Forward-Bias Safe Operating Area**

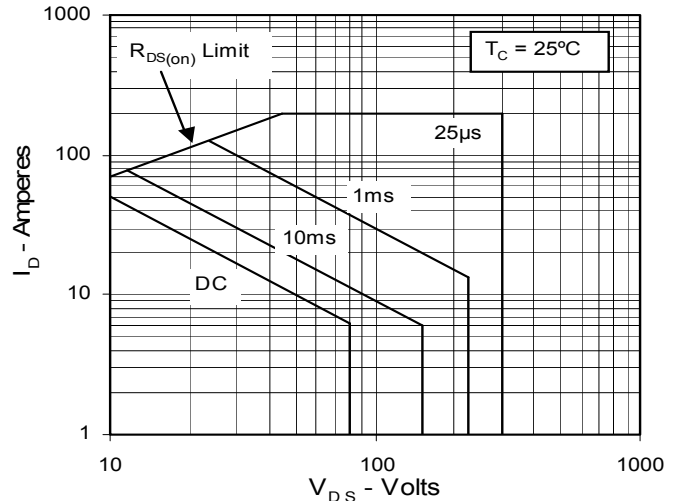
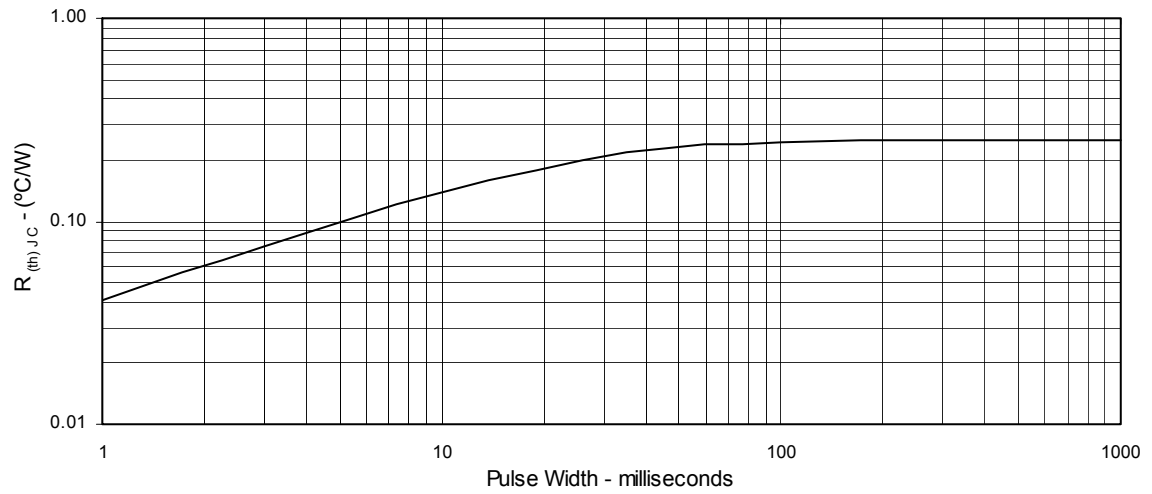

Fig. 13. Maximum Transient Thermal Resistance



单击下面可查看定价，库存，交付和生命周期等信息

[>>Littelfuse\(美国力特\)](#)