

TrenchT2™ Power MOSFET

IXTA260N055T2 IXTP260N055T2

N-Channel Enhancement Mode
Avalanche Rated

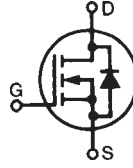

$$V_{DSS} = 55V$$

$$I_{D25} = 260A$$

$$R_{DS(on)} \leq 3.3m\Omega$$

TO-263 (IXTA)

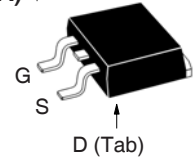

TO-220 (IXTP)

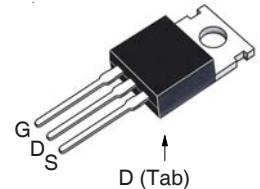

G = Gate D = Drain
S = Source Tab = Drain

Symbol	Test Conditions	Maximum Ratings	
V_{DSS}	$T_J = 25^\circ C$ to $175^\circ C$	55	V
V_{DGR}	$T_J = 25^\circ C$ to $175^\circ C$, $R_{GS} = 1M\Omega$	55	V
V_{GSM}	Transient	± 20	V
I_{D25}	$T_C = 25^\circ C$	260	A
$I_{L(RMS)}$	External Lead Current Limit	120	A
I_{DM}	$T_C = 25^\circ C$, Pulse Width Limited by T_{JM}	780	A
I_A	$T_C = 25^\circ C$	100	A
E_{AS}	$T_C = 25^\circ C$	600	mJ
P_D	$T_C = 25^\circ C$	480	W
T_J		-55 ... +175	$^\circ C$
T_{JM}		175	$^\circ C$
T_{stg}		-55 ... +175	$^\circ C$
T_L	Maximum Lead Temperature for Soldering	300	$^\circ C$
T_{SOLD}	1.6 mm (0.062in.) from Case for 10s	260	$^\circ C$
F_C	Mounting Force (TO-263)	10..65 / 2.2..14.6	N/lb
M_d	Mounting Torque (TO-220)	1.13 / 10	Nm/lb.in
Weight	TO-263	2.5	g
	TO-220	3.0	g

Features

- International Standard Packages
- Avalanche Rated
- Low Package Inductance
- Fast Intrinsic Rectifier
- 175°C Operating Temperature
- High Current Handling Capability
- ROHS Compliant
- High Performance Trench Technology for extremely low $R_{DS(on)}$

Advantages

- High Power Density
- Easy to Mount
- Space Savings

Applications

- Automotive Engine Control
- Synchronous Buck Converter (for Notebook SystemPower & General Purpose Point & Load)
- DC/DC Converters
- High Current Switching Applications
- Power Train Management
- Distributed Power Architecture

Symbol	Test Conditions ($T_J = 25^\circ C$ Unless Otherwise Specified)	Characteristic Values		
		Min.	Typ.	Max.
BV_{DSS}	$V_{GS} = 0V$, $I_D = 250\mu A$	55		V
$V_{GS(th)}$	$V_{DS} = V_{GS}$, $I_D = 250\mu A$	2.0		V
I_{GSS}	$V_{GS} = \pm 20V$, $V_{DS} = 0V$			± 200 nA
I_{DSS}	$V_{DS} = V_{DSS}$, $V_{GS} = 0V$ $T_J = 150^\circ C$			5 μA 150 μA
$R_{DS(on)}$	$V_{GS} = 10V$, $I_D = 50A$, Notes 1 & 2			3.3 m Ω

Symbol	Test Conditions ($T_J = 25^\circ\text{C}$ Unless Otherwise Specified)	Characteristic Values		
		Min.	Typ.	Max.
g_{fs}	$V_{DS} = 10\text{V}, I_D = 60\text{A}$, Note 1	55	94	S
C_{iss}	$V_{GS} = 0\text{V}, V_{DS} = 25\text{V}, f = 1\text{MHz}$		10.8	nF
C_{oss}			1460	pF
C_{rss}			215	pF
$t_{d(on)}$	Resistive Switching Times $V_{GS} = 10\text{V}, V_{DS} = 28\text{V}, I_D = 100\text{A}$ $R_G = 2\Omega$ (External)		20	ns
t_r			27	ns
$t_{d(off)}$			36	ns
t_f			24	ns
$Q_{g(on)}$	$V_{GS} = 10\text{V}, V_{DS} = 0.5 \cdot V_{DSS}, I_D = 0.5 \cdot I_{DSS}$		140	nC
Q_{gs}			52	nC
Q_{gd}			32	nC
R_{thJC}	TO-220		0.50	0.31 °C/W
R_{thCS}				

Source-Drain Diode

Symbol	Test Conditions ($T_J = 25^\circ\text{C}$ Unless Otherwise Specified)	Characteristic Values		
		Min.	Typ.	Max.
I_s	$V_{GS} = 0\text{V}$			260 A
I_{SM}	Repetitive, Pulse Width Limited by T_{JM}			1000 A
V_{SD}	$I_F = 100\text{A}, V_{GS} = 0\text{V}$, Note 1			1.3 V
t_{rr}	$I_F = 130\text{A}, V_{GS} = 0\text{V}$, $-di/dt = 100\text{A}/\mu\text{s}, V_R = 27\text{V}$		60	ns
I_{RM}			3.4	A
Q_{RM}			102	nC

- Notes: 1. Pulse test, $t \leq 300\mu\text{s}$; duty cycle, $d \leq 2\%$.
2. On through-hole packages, $R_{DS(on)}$ Kelvin test contact location must be 5mm or less from the package body.

TO-263 Outline

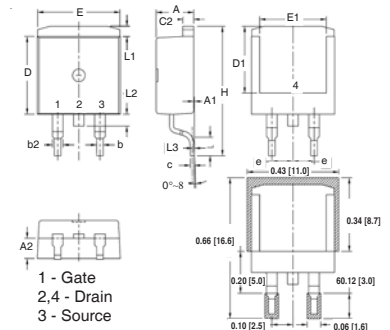

SYM	INCHES		MILLIMETER	
	MIN	MAX	MIN	MAX
A	.170	.185	4.30	4.70
A1	.000	.008	0.00	0.20
A2	.091	.098	2.30	2.50
b	.028	.035	0.70	0.90
b2	.046	.060	1.18	1.52
C	.018	.024	0.45	0.60
C2	.049	.060	1.25	1.52
D	.340	.370	8.63	9.40
D1	.300	.327	7.62	8.30
E	.380	.410	9.65	10.41
E1	.270	.330	6.86	8.38
(E)	.100 BSC		2.54 BSC	
H	.580	.620	14.73	15.75
L	.075	.105	1.91	2.67
L1	.039	.060	1.00	1.52
L2	—	.070	—	1.77
(L3)	.010 BSC		0.254 BSC	

TO-220 Outline

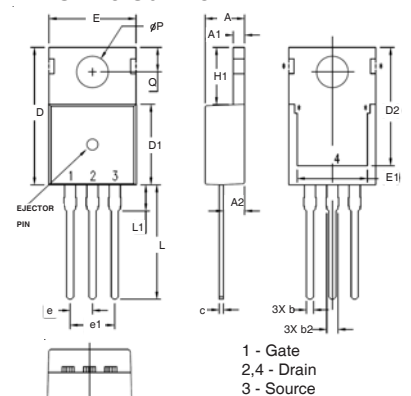

SYM	INCHES		MILLIMETERS	
	MIN	MAX	MIN	MAX
A	.169	.185	4.30	4.70
A1	.047	.055	1.20	1.40
A2	.079	.106	2.00	2.70
b	.024	.039	0.60	1.00
b2	.045	.057	1.15	1.45
c	.014	.026	0.35	0.65
D	.587	.626	14.90	15.90
D1	.335	.370	8.50	9.40
(D2)	.500	.531	12.70	13.50
E	.382	.406	9.70	10.30
(E1)	.283	.323	7.20	8.20
e	.100 BSC		2.54 BSC	
e1	.200 BSC		5.08 BSC	
H1	.244	.268	6.20	6.80
L	.492	.547	12.50	13.90
L1	.110	.154	2.80	3.90
ØP	.134	.150	3.40	3.80
Q	.106	.126	2.70	3.20

IXYS Reserves the Right to Change Limits, Test Conditions, and Dimensions.

IXYS MOSFETs and IGBTs are covered by one or more of the following U.S. patents:	4,835,592	4,931,844	5,049,961	5,237,481	6,162,665	6,404,065B1	6,683,344	6,727,585	7,005,734B2	7,157,338B2
	4,860,072	5,017,508	5,063,307	5,381,025	6,259,123B1	6,534,343	6,710,405B2	6,759,692	7,063,975B2	
	4,881,106	5,034,796	5,187,117	5,486,715	6,306,728B1	6,583,505	6,710,463	6,771,478B2	7,071,537	

Fig. 1. Output Characteristics @ $T_J = 25^\circ\text{C}$

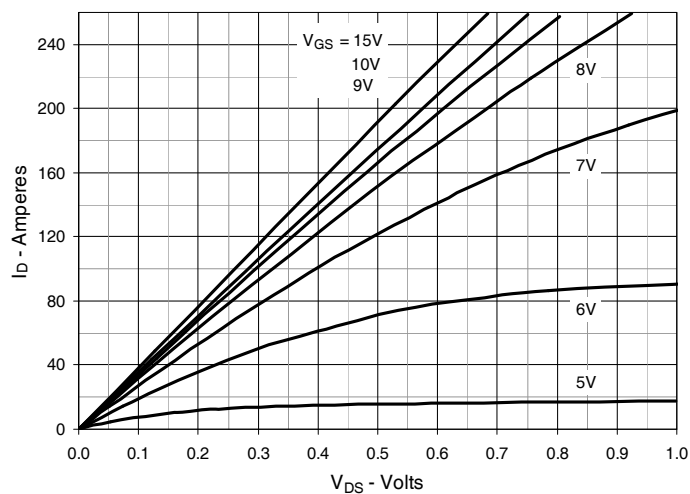

Fig. 2. Extended Output Characteristics @ $T_J = 25^\circ\text{C}$

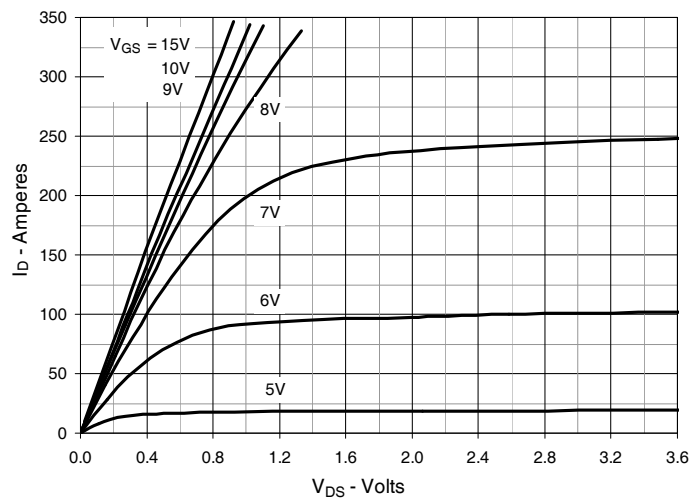

Fig. 3. Output Characteristics @ $T_J = 150^\circ\text{C}$

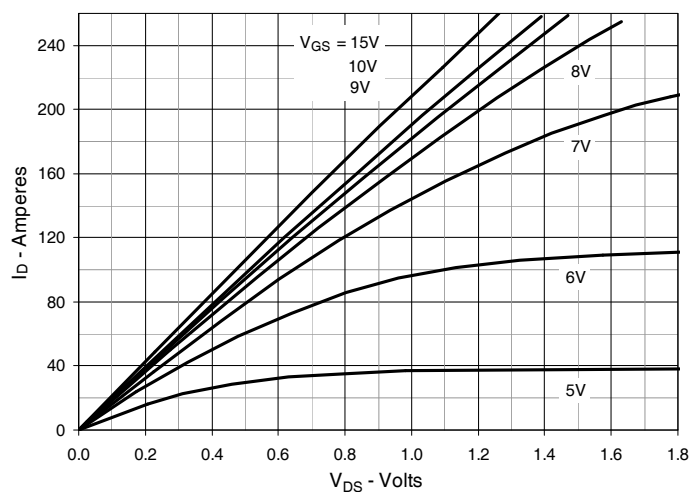

Fig. 4. $R_{DS(on)}$ Normalized to $I_D = 130\text{A}$ Value vs. Junction Temperature

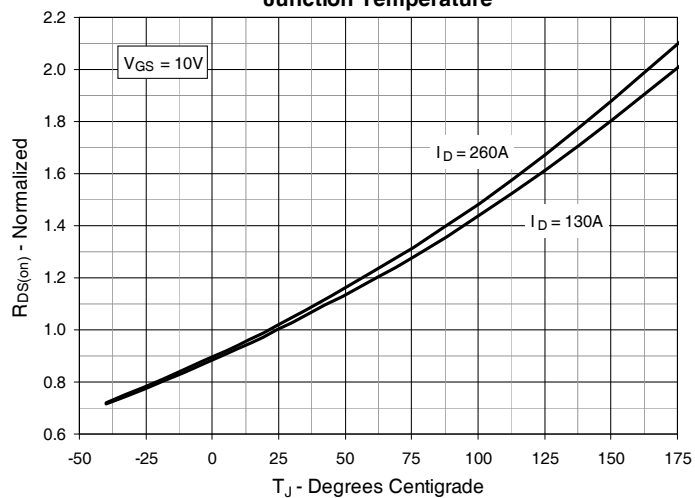

Fig. 5. $R_{DS(on)}$ Normalized to $I_D = 130\text{A}$ Value vs. Drain Current

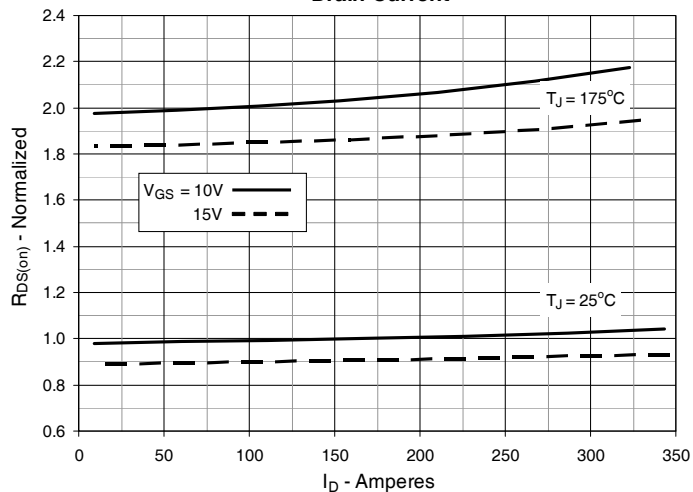

Fig. 6. Drain Current vs. Case Temperature

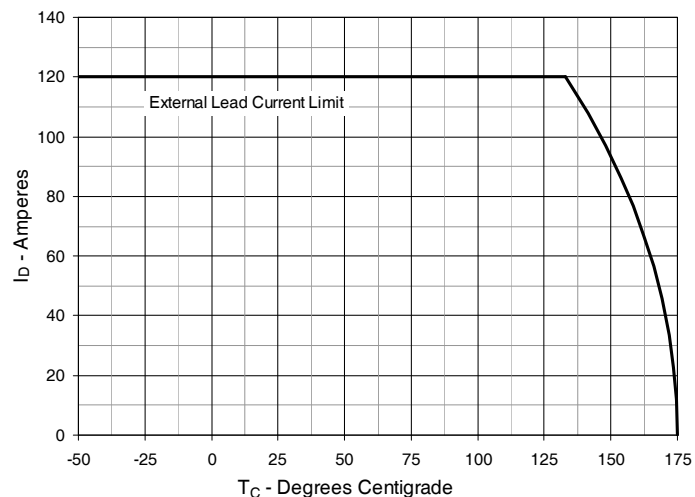

Fig. 7. Input Admittance

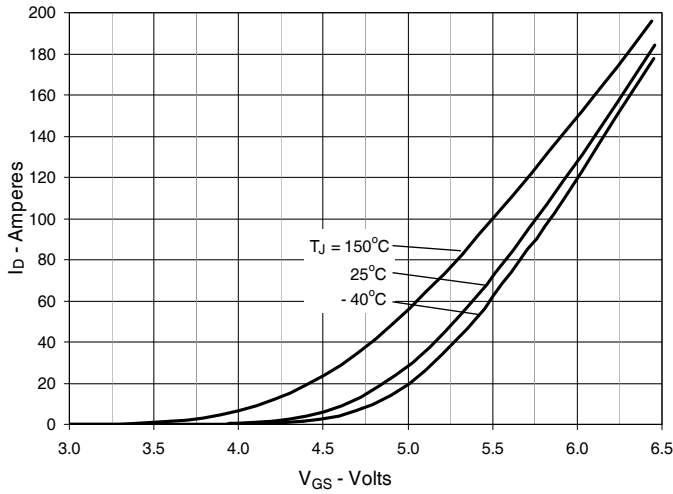

Fig. 8. Transconductance

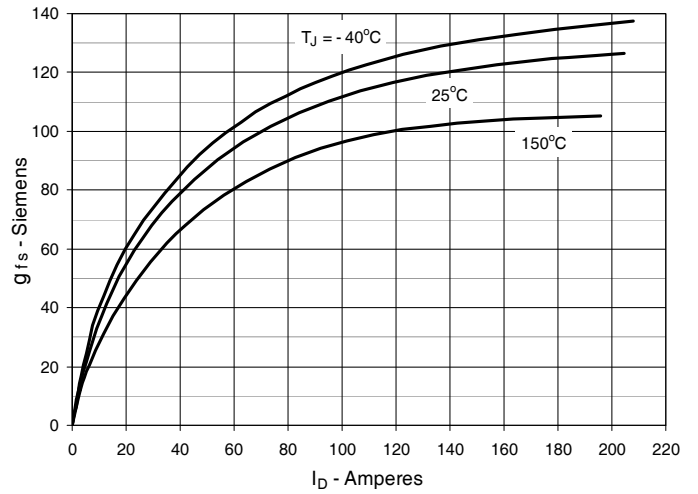

Fig. 9. Forward Voltage Drop of Intrinsic Diode

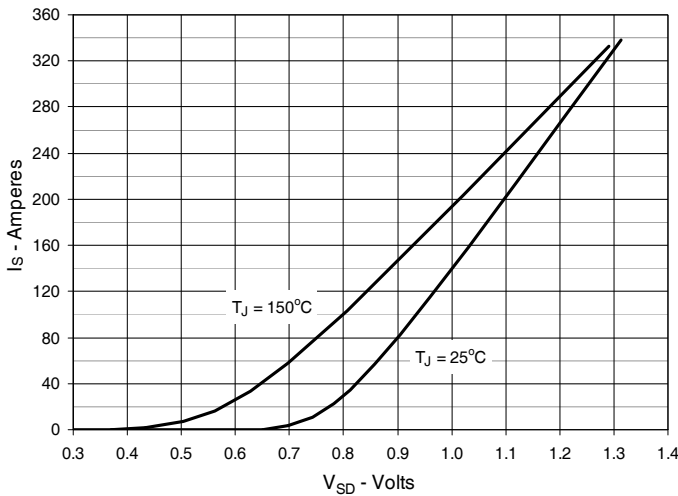

Fig. 10. Gate Charge

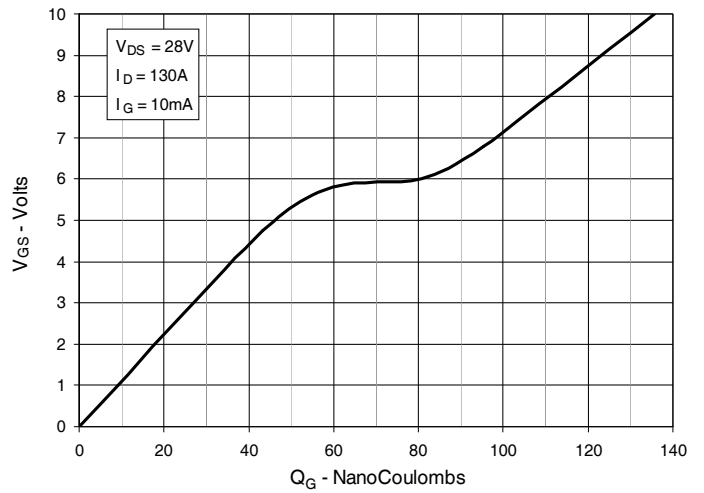

Fig. 11. Capacitance

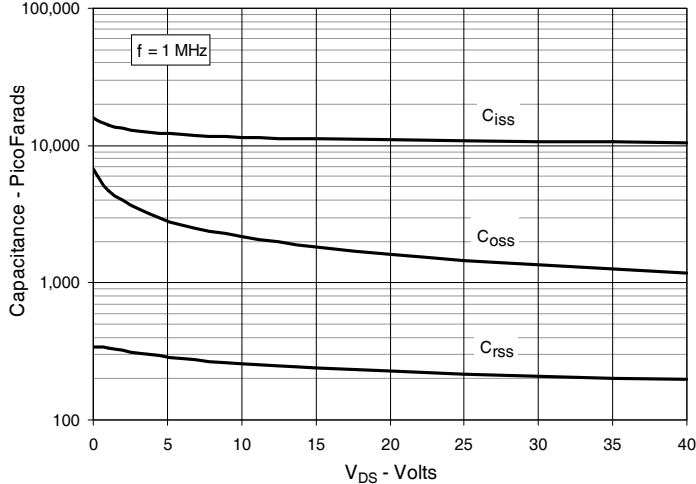

Fig. 12. Forward-Bias Safe Operating Area

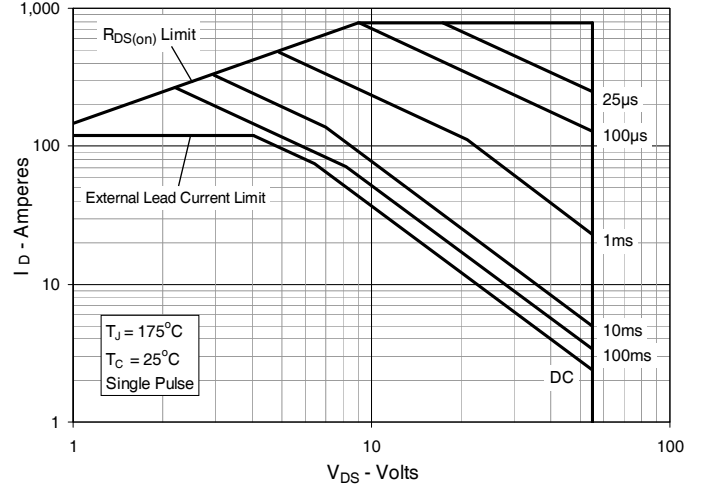

Fig. 13. Resistive Turn-on
Rise Time vs. Junction Temperature

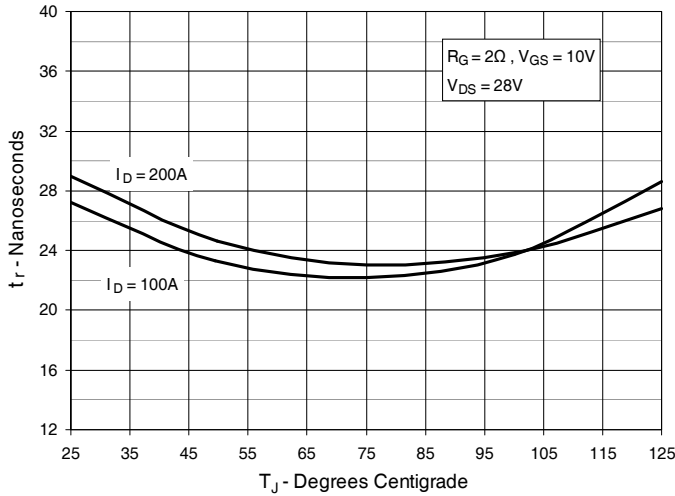

Fig. 14. Resistive Turn-on
Rise Time vs. Drain Current

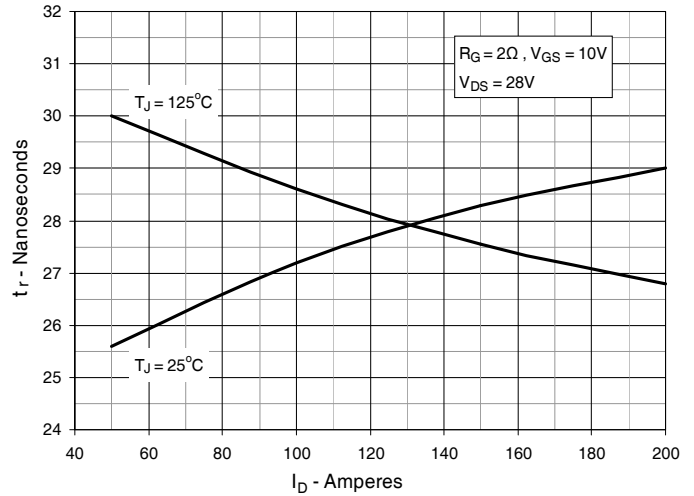

Fig. 15. Resistive Turn-on
Switching Times vs. Gate Resistance

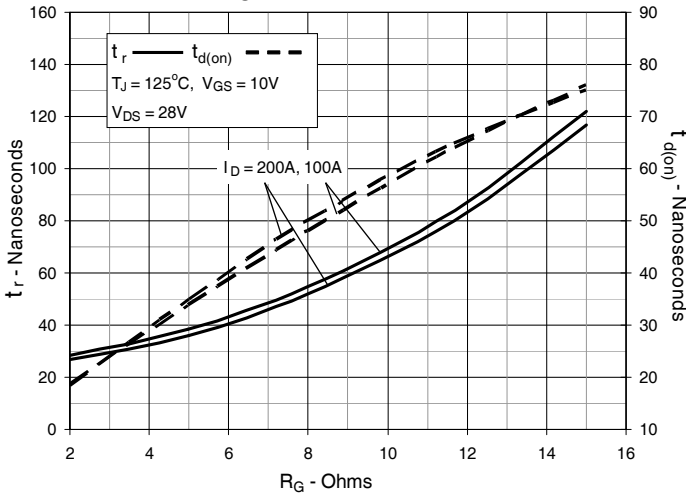

Fig. 16. Resistive Turn-off
Switching Times vs. Junction Temperature

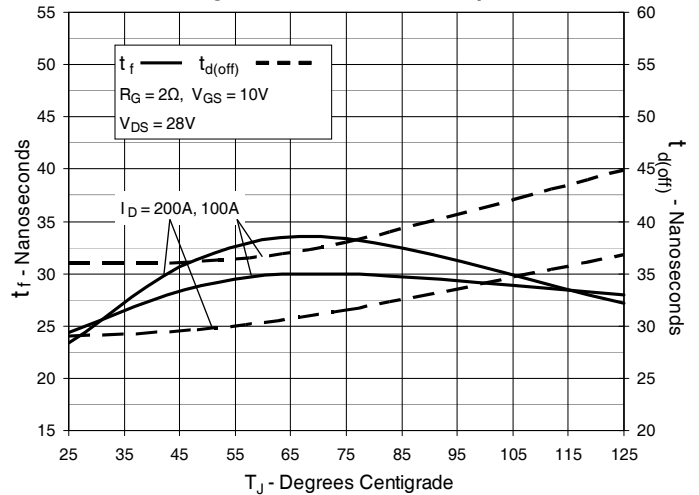

Fig. 17. Resistive Turn-off
Switching Times vs. Drain Current

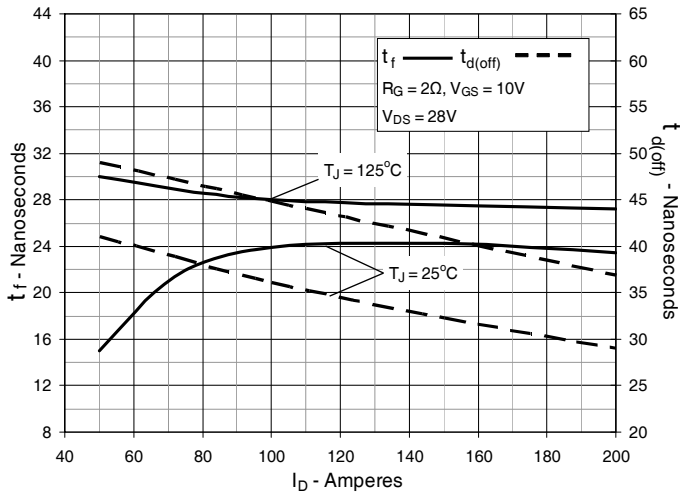

Fig. 18. Resistive Turn-off
Switching Times vs. Gate Resistance

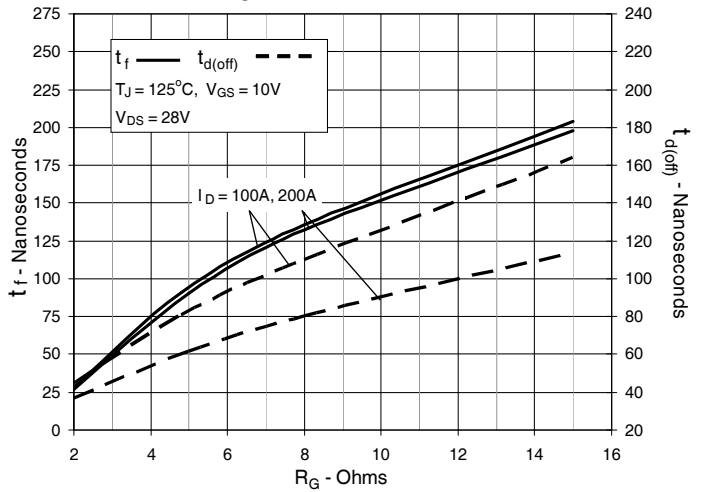
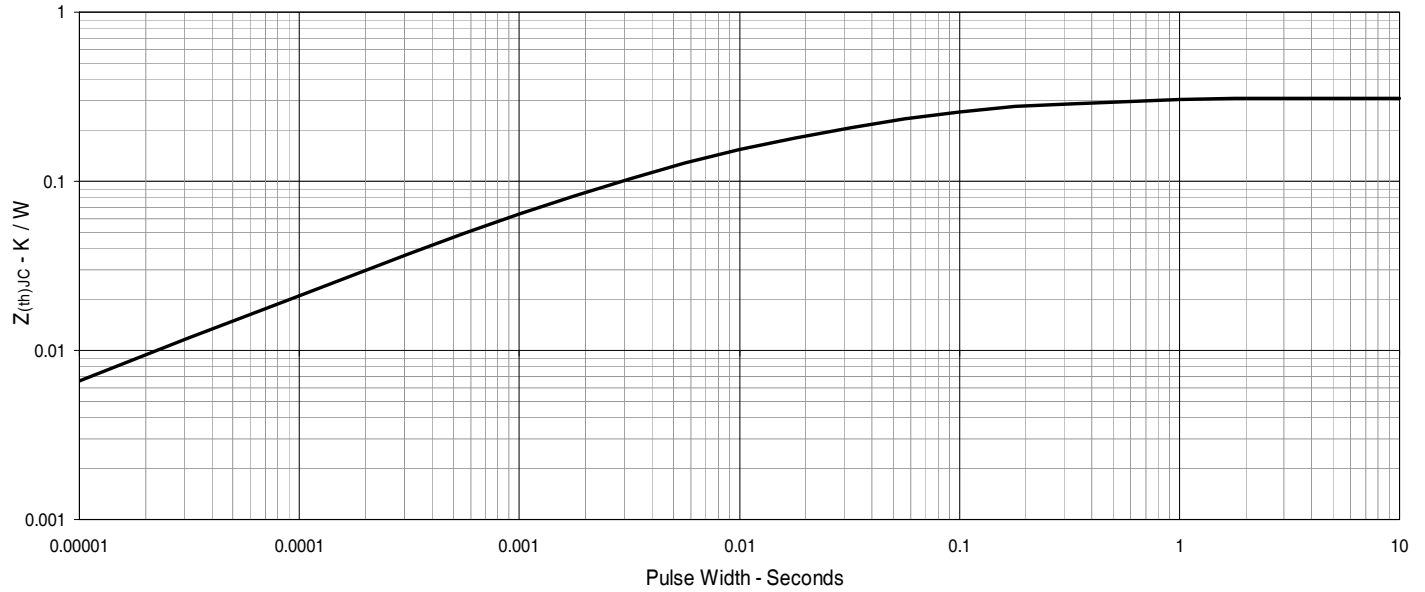

Fig. 19. Maximum Transient Thermal Impedance





Disclaimer Notice - Information furnished is believed to be accurate and reliable. However, users should independently evaluate the suitability of and test each product selected for their own applications. Littelfuse products are not designed for, and may not be used in, all applications. Read complete Disclaimer Notice at www.littelfuse.com/disclaimer-electronics.

单击下面可查看定价，库存，交付和生命周期等信息

[>>Littelfuse\(美国力特\)](#)