

SP3030 Series 0.5pF 20kV Unidirectional Discrete TVS

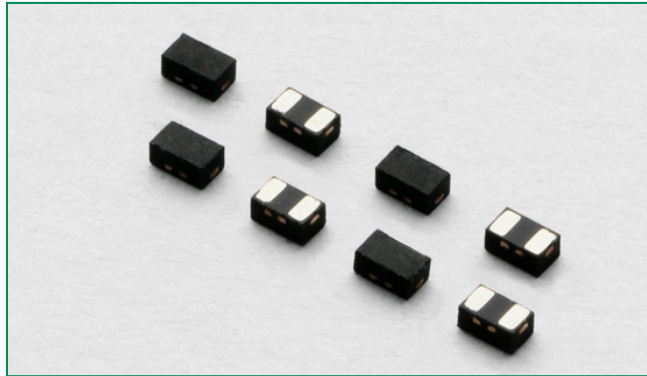

Pinout

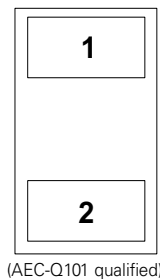

Functional Block Diagram



Life Support Note:

Not Intended for Use in Life Support or Life Saving Applications

The products shown herein are not designed for use in life sustaining or life saving applications unless otherwise expressly indicated.

HDMI Application Example

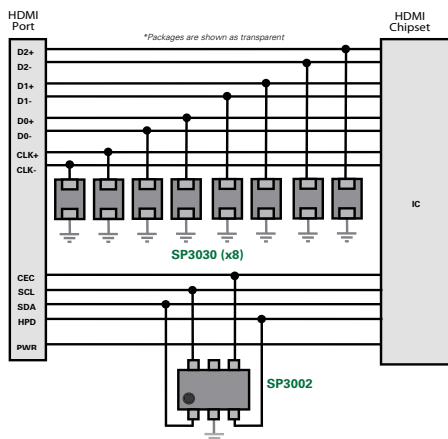

Description

The SP3030 includes low capacitance rail to rail diodes with an additional Zener diode to provide protection for electronic equipment that may experience destructive electrostatic discharges (ESD). These robust diodes can safely absorb repetitive ESD strikes above the maximum level specified in the IEC61000-4-2 international standard ($\pm 20\text{kV}$ contact discharge) without performance degradation. The low loading capacitance makes it ideal for protecting high speed data lines such as HDMI, DVI, USB2.0, USB3.0 and eSATA.

Features

- ESD protection of $\pm 20\text{kV}$ contact discharge, $\pm 30\text{kV}$ air discharge, (IEC61000-4-2)
- EFT protection, IEC61000-4-4, 40A ($t_p=5/50\text{ns}$)
- Lightning Protection, IEC61000-4-5, 3A ($t_p=8/20\mu\text{s}$)
- Low capacitance of 0.5pF @ $V_R=0\text{V}$
- Low leakage current of $0.1\mu\text{A}$ at 5V
- Small SOD882 packaging helps save board space
- AEC-Q101 qualified (SOD882 package)

Applications

- Tablets
- Ultrabook
- eReader
- Smart Phones
- Digital Cameras
- MP3/ PMP
- Set Top Boxes
- Portable Medical

USB3.0 Application Example

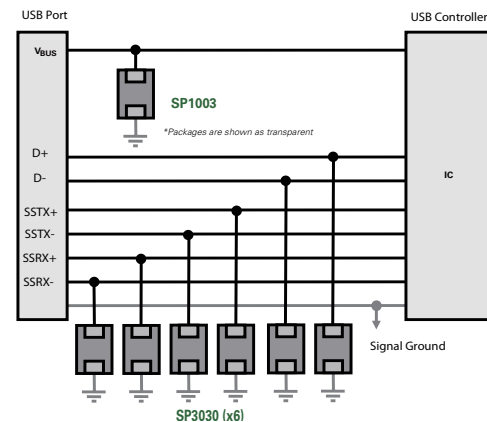

Additional Information



Datasheet



Resources



Samples

Absolute Maximum Ratings

| Symbol | Parameter | Value | Units |
|------------|----------------------------------|------------|-------|
| I_{PP} | Peak Current ($t_p=8/20\mu s$) | 3.0 | A |
| T_{OP} | Operating Temperature | -40 to 125 | °C |
| T_{STOR} | Storage Temperature | -55 to 150 | °C |

CAUTION: Stresses above those listed in "Absolute Maximum Ratings" may cause permanent damage to the device. This is a stress only rating and operation of the device at these or any other conditions above those indicated in the operational sections of this specification is not implied.

Thermal Information

| Parameter | Rating | Units |
|---|------------|-------|
| Storage Temperature Range | -55 to 150 | °C |
| Maximum Junction Temperature | 150 | °C |
| Maximum Lead Temperature (Soldering 20-40s) | 260 | °C |

Electrical Characteristics ($T_{OP}=25^\circ C$)

| Parameter | Symbol | Test Conditions | Min | Typ | Max | Units |
|------------------------------------|---------------|-------------------------------------|----------|------|-----|----------|
| Reverse Standoff Voltage | V_{RWM} | | | | 5 | V |
| Reverse Leakage Current | I_{LEAK} | $V_R=5V$ with 1pin at GND | | 0.1 | 0.5 | μA |
| Clamp Voltage ¹ | V_C | $I_{PP}=1A, t_p=8/20\mu s, Fwd$ | | 9.2 | | V |
| | | $I_{PP}=2A, t_p=8/20\mu s, Fwd$ | | 10.0 | | V |
| ESD Withstand Voltage ¹ | V_{ESD} | IEC61000-4-2 (Contact) | ± 20 | | | kV |
| | | IEC61000-4-2 (Air) | ± 30 | | | kV |
| Dynamic Resistance | R_{DYN} | $(V_{C2}-V_{C1})/(I_{PP2}-I_{PP1})$ | | 0.55 | | Ω |
| Diode Capacitance ¹ | $C_{I/O-I/O}$ | Reverse Bias=0V, f=1 MHz | | 0.5 | | pF |

Note: 1. Parameter is guaranteed by design and/or device characterization.

Insertion Loss (S21) I/O to GND

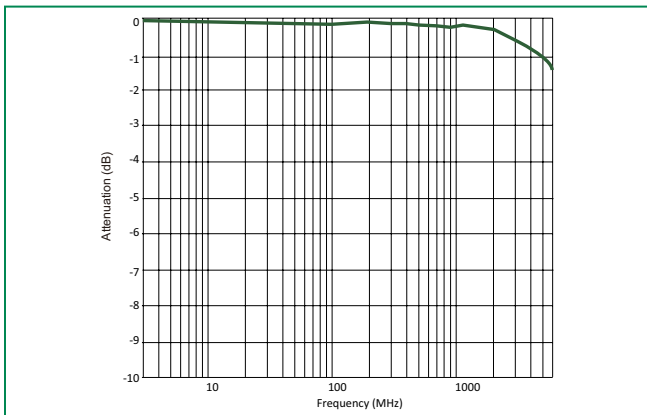

Normalized Capacitance vs. Reverse Voltage

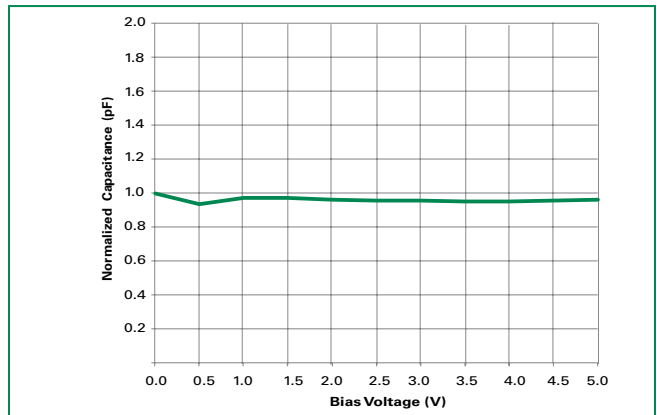

HDMI 1.4 Eye Diagram

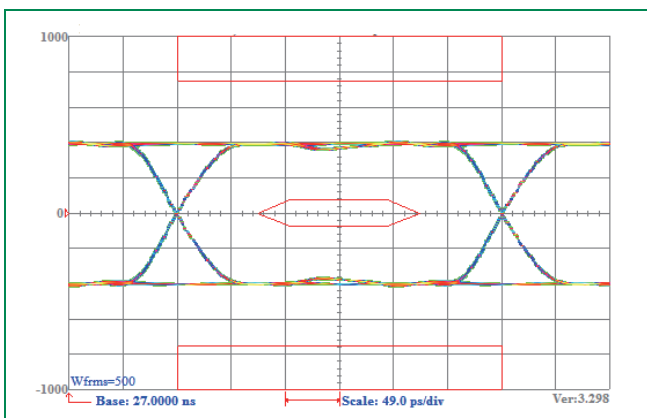

USB3.0 Eye Diagram

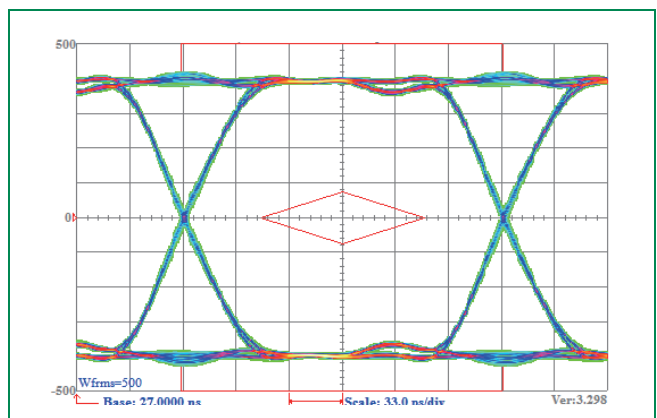

Pulse Waveform

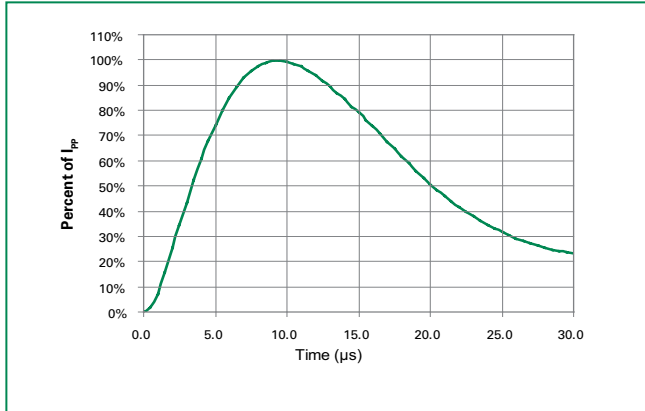

Transmission Line Pulsing (TLP) Plot

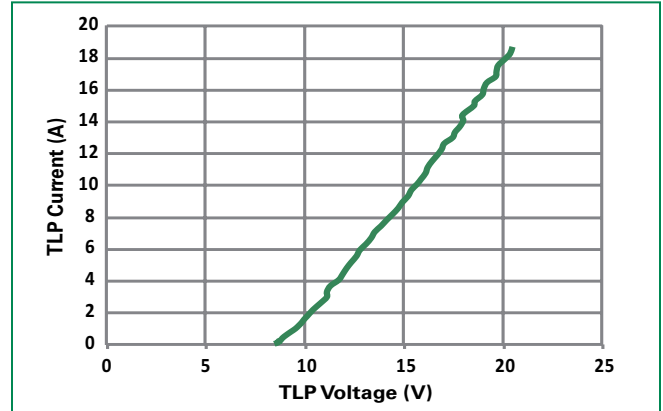

Soldering Parameters

| | | |
|--|------------------------------------|-------------------------|
| Reflow Condition | | Pb – Free assembly |
| Pre Heat | - Temperature Min ($T_{s(min)}$) | 150°C |
| | - Temperature Max ($T_{s(max)}$) | 200°C |
| | - Time (min to max) (t_s) | 60 – 180 secs |
| Average ramp up rate (Liquidus) Temp (T_L) to peak | | 3°C/second max |
| $T_{s(max)}$ to T_L - Ramp-up Rate | | 3°C/second max |
| Reflow | - Temperature (T_L) (Liquidus) | 217°C |
| | - Temperature (t_L) | 60 – 150 seconds |
| Peak Temperature (T_p) | | 260 ^{+0/-5} °C |
| Time within 5°C of actual peak Temperature (t_p) | | 20 – 40 seconds |
| Ramp-down Rate | | 6°C/second max |
| Time 25°C to peak Temperature (T_p) | | 8 minutes Max. |
| Do not exceed | | 260°C |

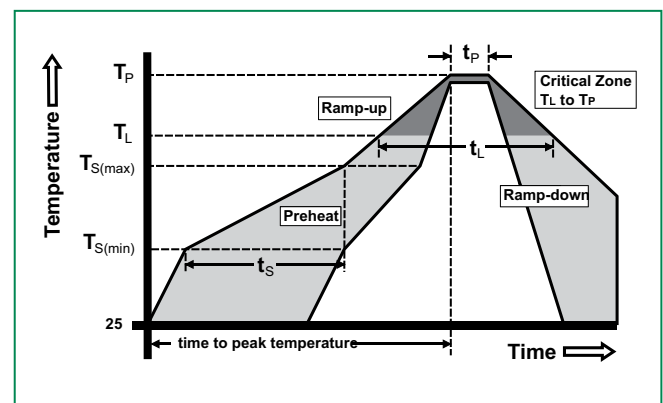

Part Numbering System

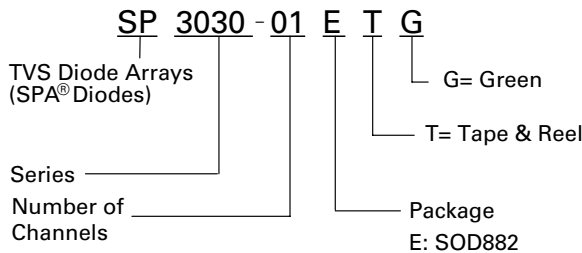

Product Characteristics

| | |
|----------------------------|-------------------------|
| Lead Plating | Pre-Plated Frame |
| Lead Material | Copper Alloy |
| Lead Coplanarity | 0.0004 inches (0.102mm) |
| Substitute Material | Silicon |
| Body Material | Molded Epoxy |
| Flammability | UL 94 V-0 |

- Notes :
- All dimensions are in millimeters
 - Dimensions include solder plating.
 - Dimensions are exclusive of mold flash & metal burr.
 - Blo is facing up for mold and facing down for trim/form, i.e. reverse trim/form.
 - Package surface matte finish VDI 11-13.

Part Marking System

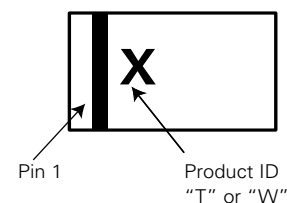

Ordering Information

| Part Number | Package | Marking | Packaging Options | P0/P1 | Packaging Specifications | Min. Order Qty. |
|--------------|---------|------------|--------------------------------|---------|--------------------------|-----------------|
| SP3030-01ETG | SOD882 | "T" or "W" | Tape & Reel - 8mm tape/7" reel | 4mm/2mm | EIA-481 | 10,000 |

Package Dimensions — SOD882

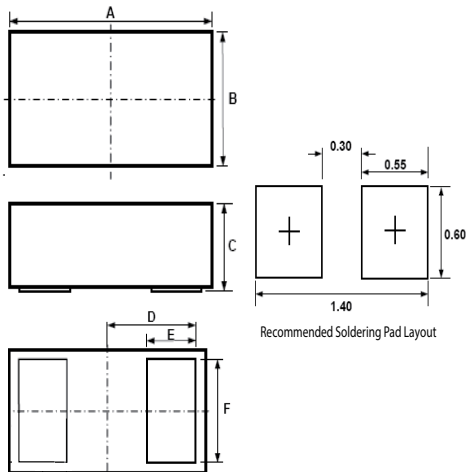

| Symbol | Package | SOD882 | | | | | |
|----------|-------------|--------|------|--------|-------|-------|--|
| | JEDEC | MO-236 | | | | | |
| | Millimeters | | | Inches | | | |
| | Min | Typ | Max | Min | Typ | Max | |
| A | 0.90 | 1.00 | 1.10 | 0.037 | 0.039 | 0.041 | |
| B | 0.50 | 0.60 | 0.70 | 0.022 | 0.024 | 0.026 | |
| C | 0.40 | 0.50 | 0.60 | 0.016 | 0.020 | 0.024 | |
| D | 0.45 | | | 0.018 | | | |
| E | 0.20 | 0.25 | 0.35 | 0.008 | 0.010 | 0.012 | |
| F | 0.45 | 0.50 | 0.55 | 0.018 | 0.020 | 0.022 | |

Embossed Carrier Tape & Reel Specification — SOD882

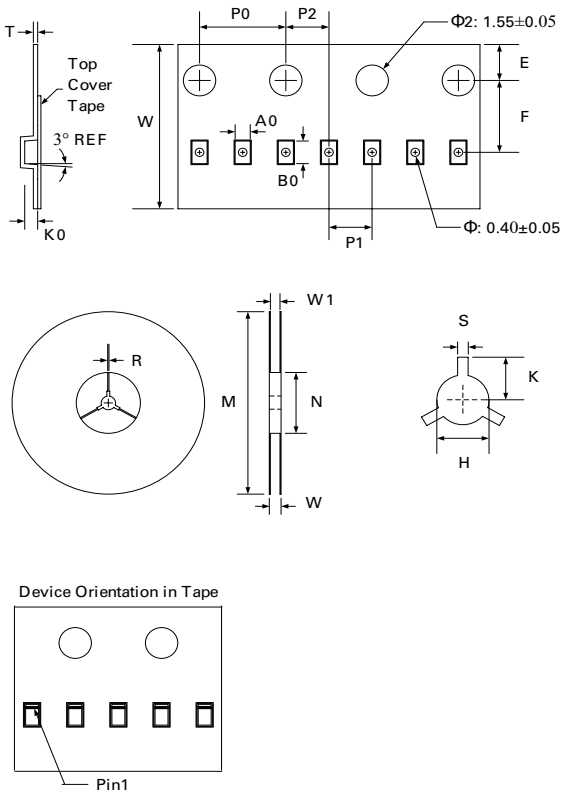

| Symbol | Tape Dimensions | |
|-----------|------------------------------|-------|
| | Millimeters | |
| | Min | Max |
| A0 | 0.65 | 0.75 |
| B0 | 1.10 | 1.20 |
| K0 | 0.50 | 0.60 |
| E | 1.65 | 1.85 |
| F | 3.45 | 3.55 |
| P0 | 3.90 | 4.10 |
| P1 | 1.90 | 2.10 |
| P2 | 1.95 | 2.05 |
| T | 1.95 | 2.05 |
| W | 7.90 | 8.10 |
| Symbol | Reel Dimensions (Size Ø 178) | |
| | Millimeters | |
| | Min | Max |
| M | 177.0 | 179.0 |
| N | 59.0 | 61.0 |
| W | 11.0 | 12.0 |
| W1 | 8.5 | 9.5 |
| H | 12.5 | 13.5 |
| S | 1.9 | 2.1 |
| K | 10.8 | 11.2 |
| R | 0.95 | 1.05 |

Disclaimer Notice - Information furnished is believed to be accurate and reliable. However, users should independently evaluate the suitability of and test each product selected for their own applications. Littelfuse products are not designed for, and may not be used in, all applications. Read complete Disclaimer Notice at www.littelfuse.com/disclaimer-electronics.

单击下面可查看定价，库存，交付和生命周期等信息

[>>Littelfuse\(美国力特\)](#)