

TrenchT2™
Power MOSFET
IXTH440N055T2
IXTT440N055T2

$$V_{DSS} = 55V$$

$$I_{D25} = 440A$$

$$R_{DS(on)} \leq 1.8m\Omega$$

N-Channel Enhancement Mode
 Avalanche Rated
 Fast Intrinsic Diode

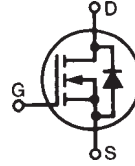

| Symbol | Test Conditions | Maximum Ratings | |
|---------------|---|-----------------|------------|
| V_{DSS} | $T_J = 25^\circ C$ to $175^\circ C$ | 55 | V |
| V_{DGR} | $T_J = 25^\circ C$ to $175^\circ C$, $R_{GS} = 1M\Omega$ | 55 | V |
| V_{GSS} | Continuous | ± 20 | V |
| V_{GSM} | Transient | ± 30 | V |
| I_{D25} | $T_C = 25^\circ C$ (Chip Capability) | 440 | A |
| I_{LRMS} | Lead Current Limit, RMS | 160 | A |
| I_{DM} | $T_C = 25^\circ C$, Pulse Width Limited by T_{JM} | 1200 | A |
| I_A | $T_C = 25^\circ C$ | 200 | A |
| E_{AS} | $T_C = 25^\circ C$ | 1.5 | J |
| P_D | $T_C = 25^\circ C$ | 1000 | W |
| T_J | | -55 ... +175 | $^\circ C$ |
| T_{JM} | | 175 | $^\circ C$ |
| T_{stg} | | -55 ... +175 | $^\circ C$ |
| T_L | 1.6mm (0.062in.) from Case for 10s | 300 | $^\circ C$ |
| T_{sold} | Plastic Body for 10 seconds | 260 | $^\circ C$ |
| M_d | Mounting Torque (TO-247) | 1.13 / 10 | Nm/lb.in. |
| Weight | TO-247 | 6 | g |
| | TO-268 | 4 | g |

| Symbol | Test Conditions | Characteristic Values | | |
|--------------|---|-----------------------|------|---------------|
| | | Min. | Typ. | Max. |
| BV_{DSS} | $V_{GS} = 0V$, $I_D = 1mA$ | 55 | | V |
| $V_{GS(th)}$ | $V_{DS} = V_{GS}$, $I_D = 250\mu A$ | 2.0 | | V |
| I_{GSS} | $V_{GS} = \pm 20V$, $V_{DS} = 0V$ | | | ± 200 nA |
| I_{DSS} | $V_{DS} = V_{DSS}$, $V_{GS} = 0V$ $T_J = 150^\circ C$ | | | 10 μA |
| | | | | 750 μA |
| $R_{DS(on)}$ | $V_{GS} = 10V$, $I_D = 100A$, Notes 1 & 2 | | | 1.8 $m\Omega$ |

TO-247 (IXTH)

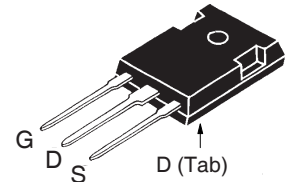

TO-268 (IXTT)

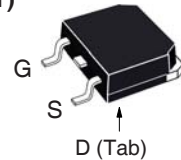

G = Gate D = Drain
 S = Source Tab = Drain

Features

- International Standard Packages
- $175^\circ C$ Operating Temperature
- High Current Handling Capability
- Avalanche Rated
- Fast Intrinsic Diode
- Low $R_{DS(on)}$

Advantages

- Easy to Mount
- Space Savings
- High Power Density

Applications

- DC/DC Converters and Off-line UPS
- Primary- Side Switch
- High Current Switching Applications

| Symbol | Test Conditions ($T_J = 25^\circ\text{C}$, Unless Otherwise Specified) | Characteristic Values | | |
|--------------|--|-----------------------|------|------------------------|
| | | Min. | Typ. | Max. |
| g_{fs} | $V_{DS} = 10\text{V}$, $I_D = 60\text{A}$, Note 1 | 85 | 140 | S |
| C_{iss} | $V_{GS} = 0\text{V}$, $V_{DS} = 25\text{V}$, $f = 1\text{MHz}$ | | 25 | nF |
| C_{oss} | | | 3370 | pF |
| C_{rss} | | | 645 | pF |
| R_{Gi} | Gate Input Resistance | | 1.24 | Ω |
| $t_{d(on)}$ | Resistive Switching Times $V_{GS} = 10\text{V}$, $V_{DS} = 0.5 \cdot V_{DSS}$, $I_D = 200\text{A}$ $R_G = 1\Omega$ (External) | | 26 | ns |
| t_r | | | 28 | ns |
| $t_{d(off)}$ | | | 72 | ns |
| t_f | | | 62 | ns |
| $Q_{g(on)}$ | $V_{GS} = 10\text{V}$, $V_{DS} = 0.5 \cdot V_{DSS}$, $I_D = 0.5 \cdot I_{D25}$ | | 405 | nC |
| Q_{gs} | | | 92 | nC |
| Q_{gd} | | | 102 | nC |
| R_{thJC} | | | | 0.15°C/W |
| R_{thCH} | TO-247 | | 0.21 | $^\circ\text{C/W}$ |

Source-Drain Diode

| Symbol | Test Conditions ($T_J = 25^\circ\text{C}$, Unless Otherwise Specified) | Characteristic Values | | |
|----------|--|-----------------------|------|--------|
| | | Min. | Typ. | Max. |
| I_S | $V_{GS} = 0\text{V}$ | | | 440 A |
| I_{SM} | Repetitive, Pulse Width Limited by T_{JM} | | | 1400 A |
| V_{SD} | $I_F = 100\text{A}$, $V_{GS} = 0\text{V}$, Note 1 | | | 1.2 V |
| t_{rr} | $I_F = 100\text{A}$, $V_{GS} = 0\text{V}$ $-di/dt = 100\text{A}/\mu\text{s}$ $V_R = 27.5\text{V}$ | | 76 | ns |
| I_{RM} | | | 3.7 | A |
| Q_{RM} | | | 140 | nC |

Notes:

1. Pulse test, $t \leq 300\mu\text{s}$, duty cycle, $d \leq 2\%$.
2. Includes lead resistance.

ADVANCE TECHNICAL INFORMATION

The product presented herein is under development. The Technical Specifications offered are derived from a subjective evaluation of the design, based upon prior knowledge and experience, and constitute a "considered reflection" of the anticipated result. IXYS reserves the right to change limits, test conditions, and dimensions without notice.

IXYS Reserves the Right to Change Limits, Test Conditions, and Dimensions.

| | | | | | | | | | | |
|--|-----------|-----------|-----------|-----------|--------------|--------------|--------------|--------------|--------------|-------------|
| IXYS MOSFETs and IGBTs are covered by one or more of the following U.S. patents: | 4,835,592 | 4,931,844 | 5,049,961 | 5,237,481 | 6,162,665 | 6,404,065 B1 | 6,683,344 | 6,727,585 | 7,005,734 B2 | 7,157,338B2 |
| | 4,850,072 | 5,017,508 | 5,063,307 | 5,381,025 | 6,259,123 B1 | 6,534,343 | 6,710,405 B2 | 6,759,692 | 7,063,975 B2 | |
| | 4,881,106 | 5,034,796 | 5,187,117 | 5,486,715 | 6,306,728 B1 | 6,583,505 | 6,710,463 | 6,771,478 B2 | 7,071,537 | |

TO-247 (IXTH) Outline

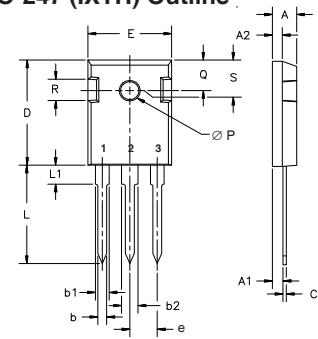

Terminals: 1 - Gate
3 - Source
2 - Drain
Tab - Drain

| Dim. | Millimeter | | Inches | |
|----------------|------------|-------|--------|-------|
| | Min. | Max. | Min. | Max. |
| A | 4.7 | 5.3 | .185 | .209 |
| A ₁ | 2.2 | 2.54 | .087 | .102 |
| A ₂ | 2.2 | 2.6 | .059 | .098 |
| b | 1.0 | 1.4 | .040 | .055 |
| b ₁ | 1.65 | 2.13 | .065 | .084 |
| b ₂ | 2.87 | 3.12 | .113 | .123 |
| C | .4 | .8 | .016 | .031 |
| D | 20.80 | 21.46 | .819 | .845 |
| E | 15.75 | 16.26 | .610 | .640 |
| e | 5.20 | 5.72 | 0.205 | 0.225 |
| L | 19.81 | 20.32 | .780 | .800 |
| L1 | | 4.50 | | .177 |
| ∅P | 3.55 | 3.65 | .140 | .144 |
| Q | 5.89 | 6.40 | 0.232 | 0.252 |
| R | 4.32 | 5.49 | .170 | .216 |
| S | 6.15 | BSC | 242 | BSC |

TO-268 (IXTT) Outline

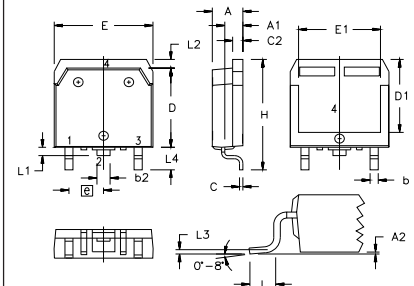

Terminals: 1 - Gate
3 - Source
2 - Drain
Tab - Drain

| SYM | INCHES | | MILLIMETERS | |
|-----|----------|------|-------------|-------|
| | MIN | MAX | MIN | MAX |
| A | .193 | .201 | 4.90 | 5.10 |
| A1 | .106 | .114 | 2.70 | 2.90 |
| A2 | .001 | .010 | 0.02 | 0.25 |
| b | .045 | .057 | 1.15 | 1.45 |
| b2 | .075 | .083 | 1.90 | 2.10 |
| C | .016 | .026 | 0.40 | 0.65 |
| C2 | .057 | .063 | 1.45 | 1.60 |
| D | .543 | .551 | 13.80 | 14.00 |
| D1 | .488 | .500 | 12.40 | 12.70 |
| E | .624 | .632 | 15.85 | 16.05 |
| E1 | .524 | .535 | 13.30 | 13.60 |
| e | .215 BSC | | 5.45 BSC | |
| H | .736 | .752 | 18.70 | 19.10 |
| L | .094 | .106 | 2.40 | 2.70 |
| L1 | .047 | .055 | 1.20 | 1.40 |
| L2 | .039 | .045 | 1.00 | 1.15 |
| L3 | .010 BSC | | 0.25 BSC | |
| L4 | .150 | .161 | 3.80 | 4.10 |

Fig. 1. Output Characteristics @ $T_J = 25^\circ\text{C}$

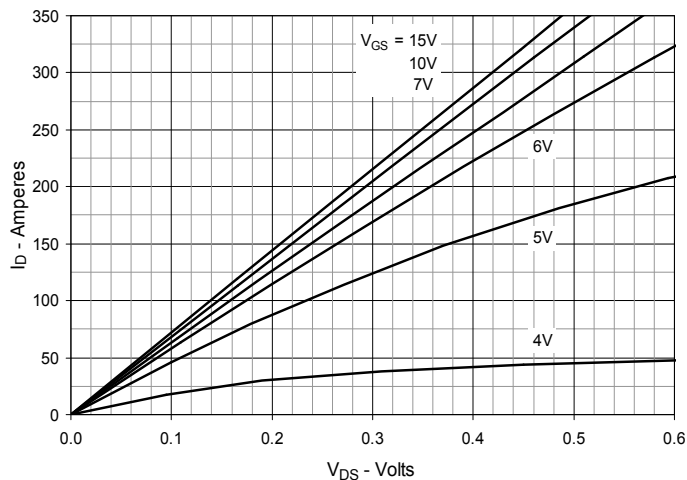

Fig. 2. Extended Output Characteristics @ $T_J = 25^\circ\text{C}$

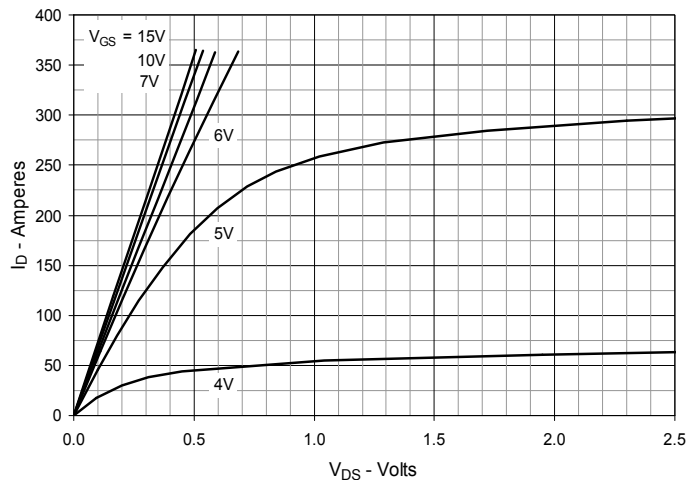

Fig. 3. Output Characteristics @ $T_J = 150^\circ\text{C}$

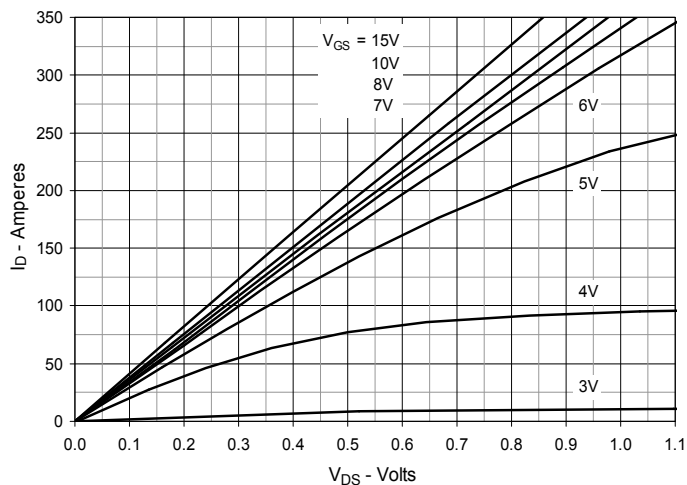

Fig. 4. $R_{DS(on)}$ Normalized vs. Junction Temperature

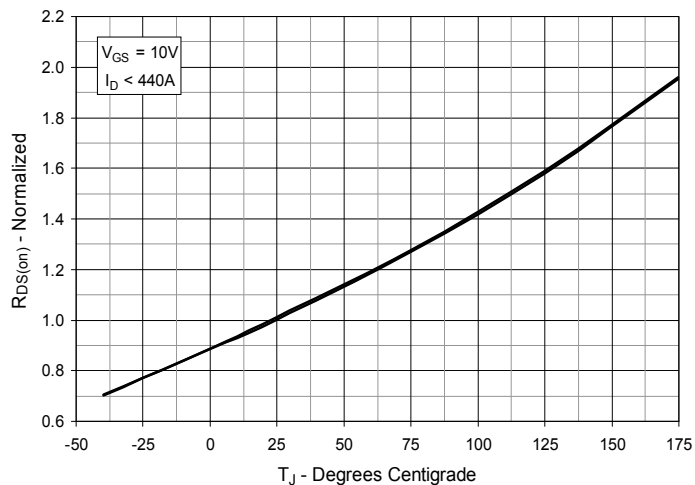

Fig. 5. $R_{DS(on)}$ Normalized vs. Drain Current

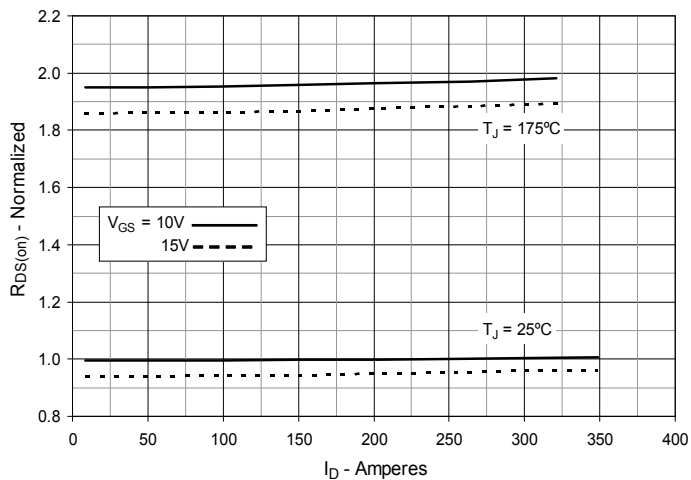

Fig. 6. Drain Current vs. Case Temperature

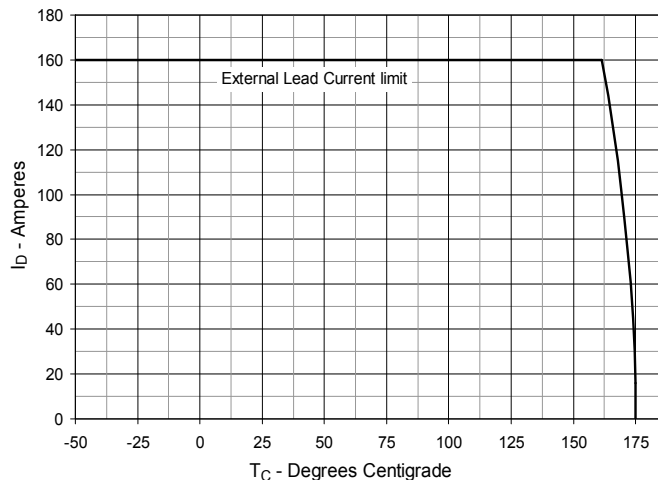

Fig. 7. Input Admittance

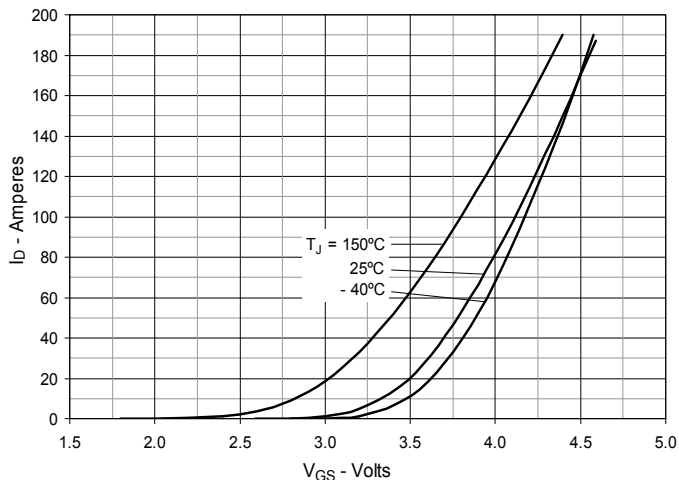

Fig. 8. Transconductance

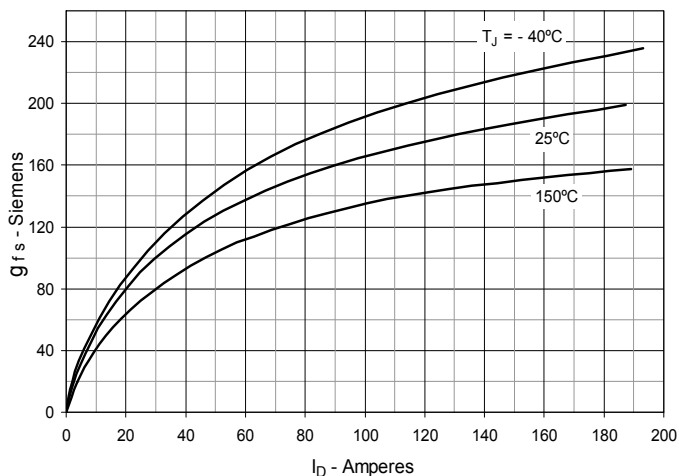

Fig. 9. Forward Voltage Drop of Intrinsic Diode

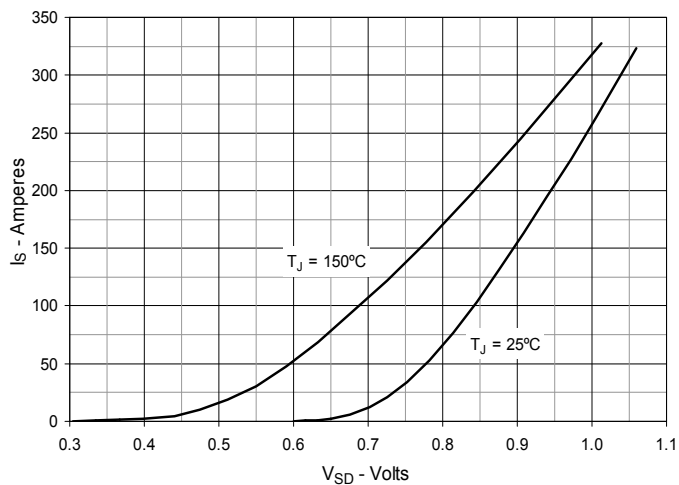

Fig. 10. Gate Charge

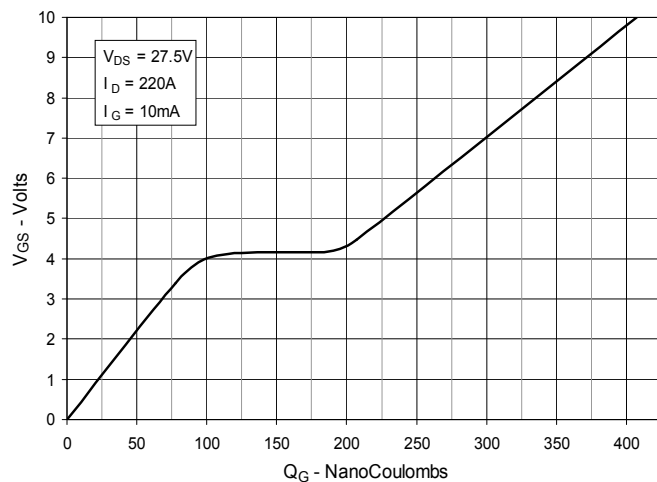

Fig. 11. Capacitance

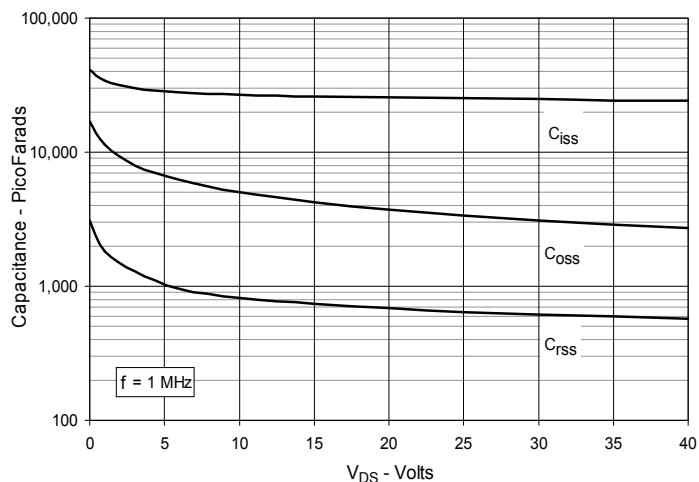

Fig. 12. Forward-Bias Safe Operating Area

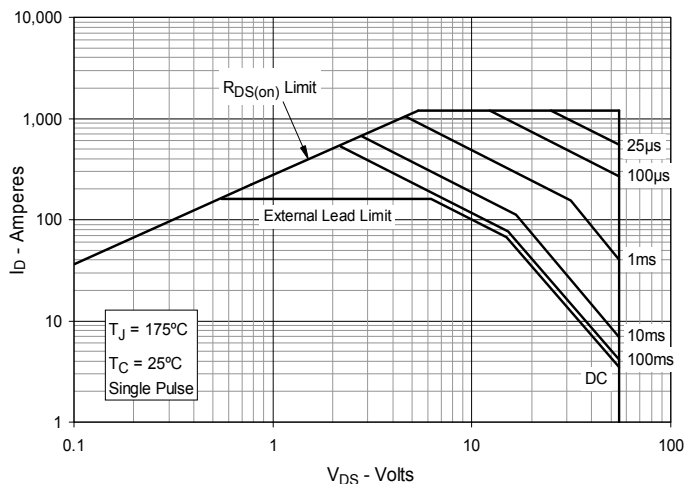

Fig. 13. Resistive Turn-on Rise Time vs. Junction Temperature

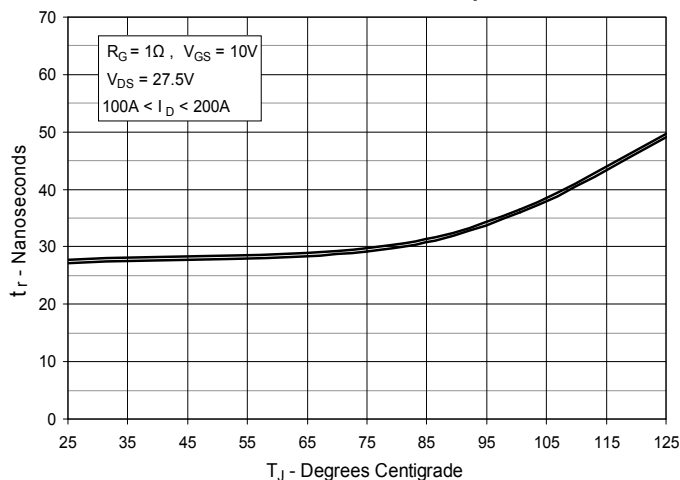

Fig. 14. Resistive Turn-on Rise Time vs. Drain Current

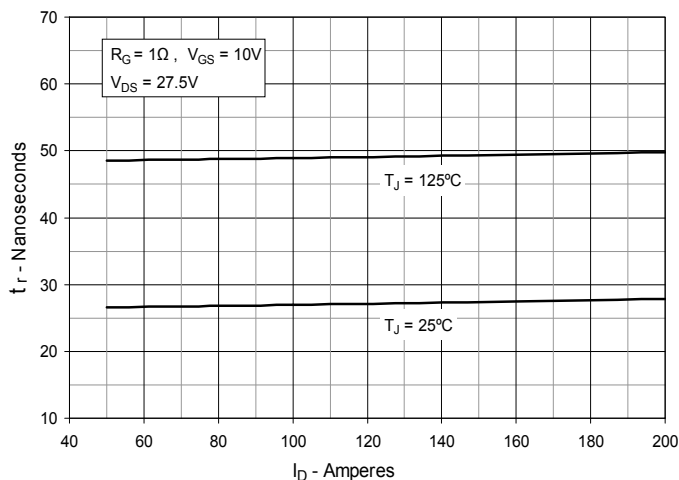

Fig. 15. Resistive Turn-on Switching Times vs. Gate Resistance

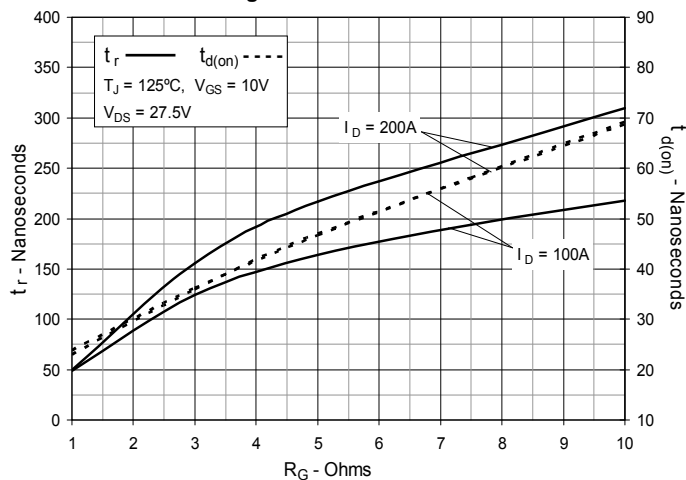

Fig. 16. Resistive Turn-off Switching Times vs. Junction Temperature

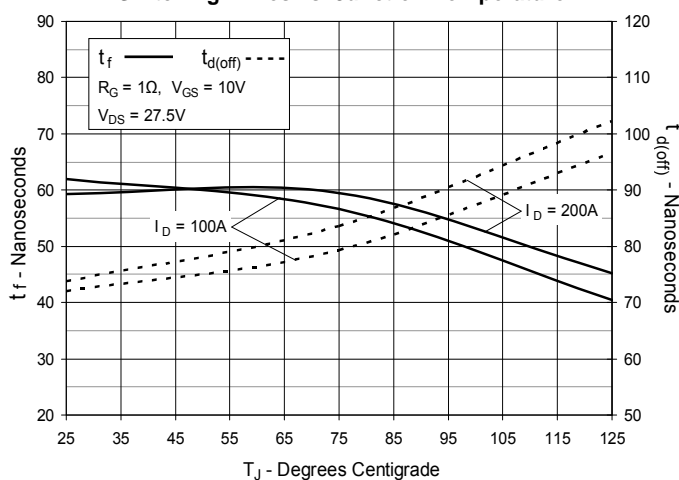

Fig. 17. Resistive Turn-off Switching Times vs. Drain Current

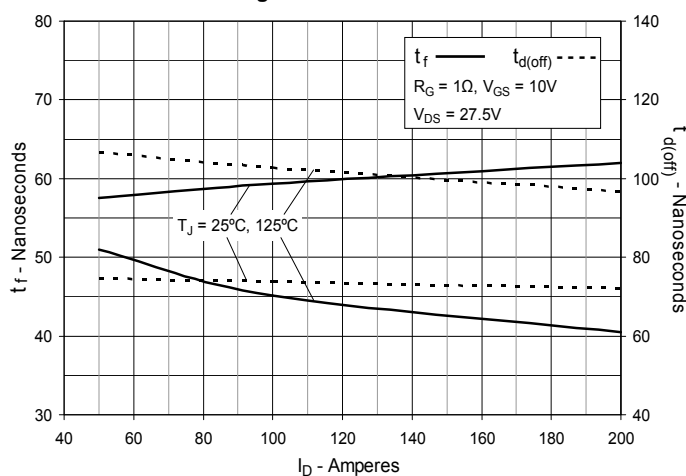

Fig. 18. Resistive Turn-off Switching Times vs. Gate Resistance

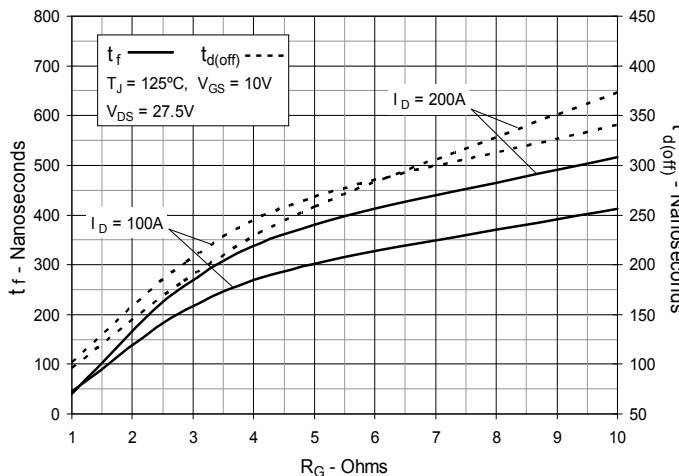
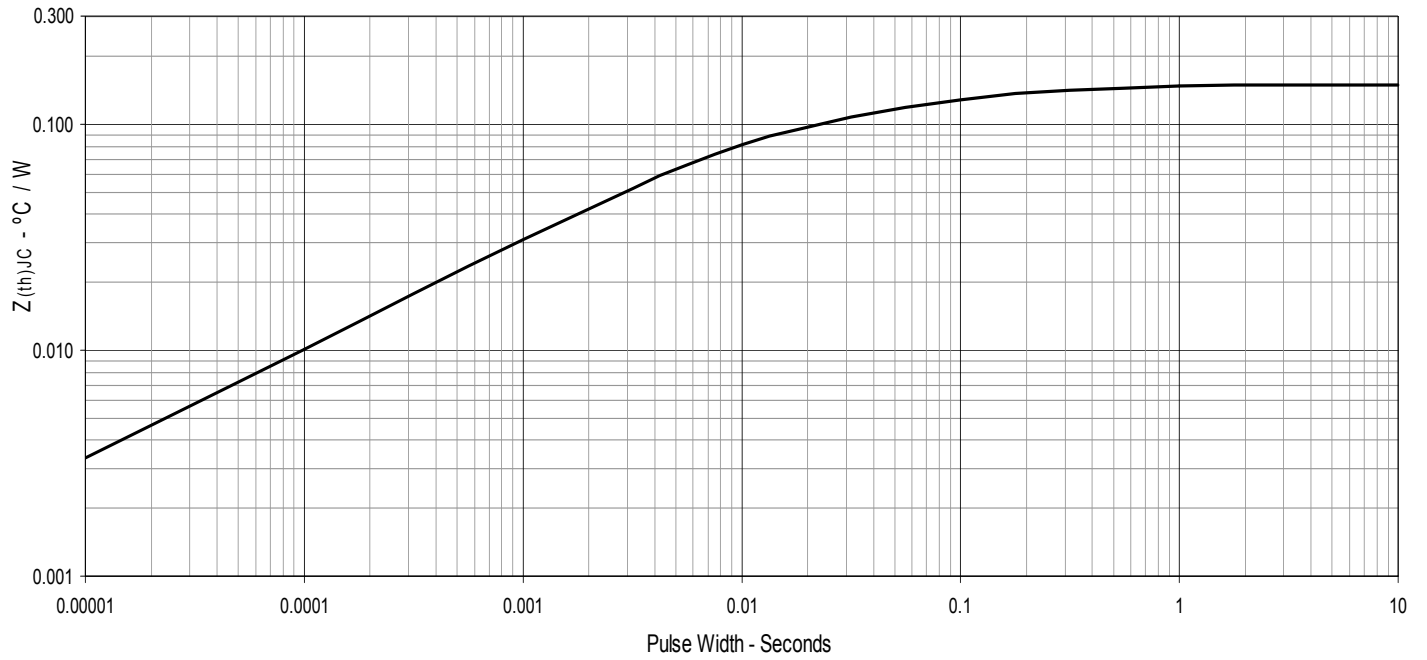

Fig. 19. Maximum Transient Thermal Impedance





Disclaimer Notice - Information furnished is believed to be accurate and reliable. However, users should independently evaluate the suitability of and test each product selected for their own applications. Littelfuse products are not designed for, and may not be used in, all applications. Read complete Disclaimer Notice at www.littelfuse.com/disclaimer-electronics.

单击下面可查看定价，库存，交付和生命周期等信息

[>>Littelfuse\(美国力特\)](#)