

DSTF20120C

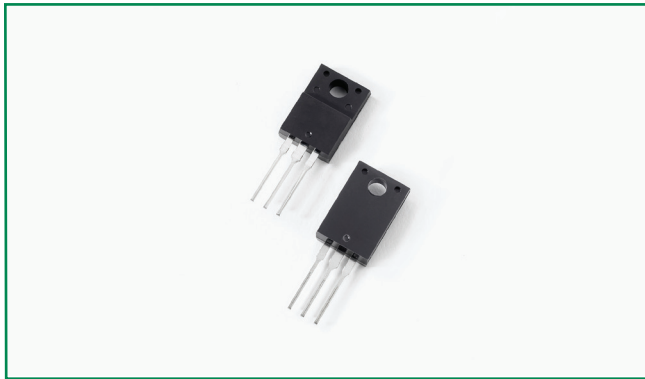

Pin out

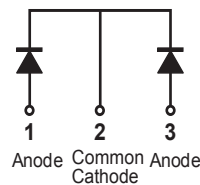

Description

Littelfuse DST series Ultra Low V_F Schottky Barrier Rectifier is designed to meet the general requirements of commercial and industry applications by providing high temperature, low leakage and lower V_F products.

It is suitable for high frequency switching mode power supply, free-wheeling diodes and polarity protection diodes.

Features

- Ultra low forward voltage drop
- High frequency operation
- High junction temperature capability
- Guard ring for enhanced ruggedness and long term reliability
- Common cathode configuration in ITO-220AB package

Applications

- Switching mode power supply
- DC/DC converters
- Free-Wheeling diodes
- Polarity Protection Diodes

Maximum Ratings

Parameters	Symbol	Test Conditions	Max	Unit
Peak Inverse Voltage	V_{RWM}	-	120	V
Average Forward Current	$I_{F(AV)}$	50% duty cycle @ $T_C = 74^\circ\text{C}$ rectangular wave form	10 (per leg)	A
			20 (total device)	
Peak One Cycle Non-Repetitive Surge Current (per leg)	I_{FSM}	8.3 ms, half Sine pulse	150	A

Electrical Characteristics

Parameters	Symbol	Test Conditions	Max	Unit
Forward Voltage Drop (per leg) *	V_{F1}	@10A, Pulse, $T_J = 25^\circ\text{C}$	0.90	V
	V_{F2}	@10A, Pulse, $T_J = 125^\circ\text{C}$	0.72	
Reverse Current (per leg) *	I_{R1}	@ $V_R = \text{rated } V_R, T_J = 25^\circ\text{C}$	0.7	mA
	I_{R2}	@ $V_R = \text{rated } V_R, T_J = 125^\circ\text{C}$	45	
RSM Isolation Voltage ($t = 1.0$ second, R. H. $\leq 30\%$, $T_A = 25^\circ\text{C}$)	V_{ISO}	Clip mounting, the epoxy body away from the heatsink edge by more than 0.110" along the lead direction.	4500	V
		Clip mounting, the epoxy body is inside the heatsink.	3500	
		Screw mounting, the epoxy body is inside the heatsink.	1500	

* Pulse Width < 300 μs , Duty Cycle < 2%

Thermal-Mechanical Specifications

Parameters	Symbol	Test Conditions	Max	Unit
Junction Temperature	T_J		-55 to +150	°C
Storage Temperature	T_{stg}		-55 to +150	°C
Thermal Resistance Junction to Case (per leg)	R_{thJC}	DC operation	5.0	°C/W
Approximate Weight	wt		2	g
Case Style		ITO-220AB		

Figure 1: Typical Forward Characteristics

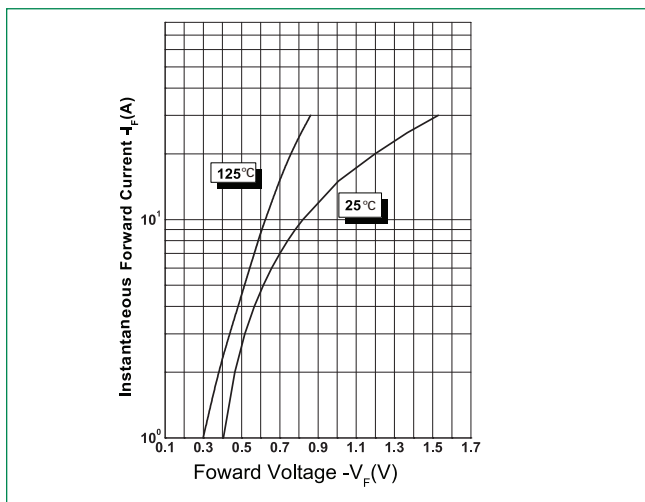

Figure 2: Typical Reverse Characteristics

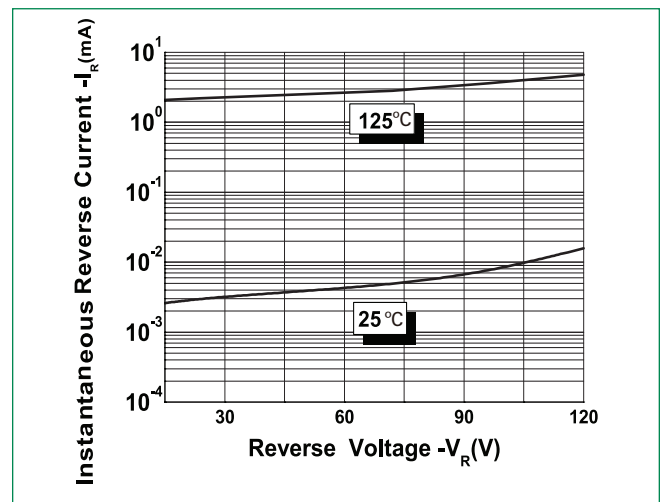
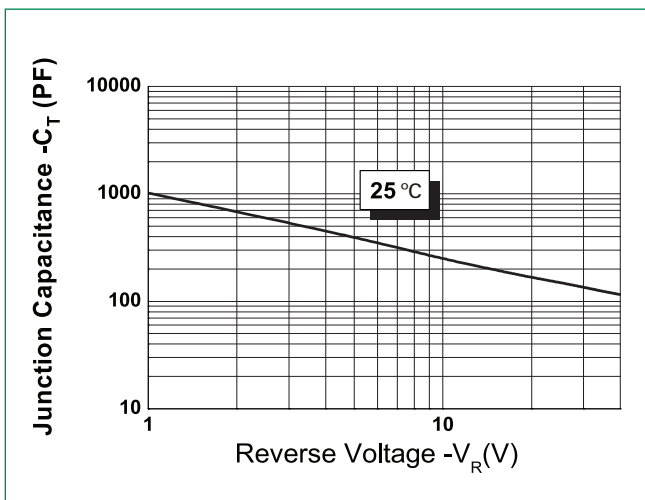

Figure 3: Typical Junction Capacitance



Dimensions- ITO-220AB



Symbol	Millimeters		
	Min	Typ	Max
A	4.30	4.50	4.70
A1	1.10	1.30	1.50
A2	2.80	3.00	3.20
A3	2.50	2.70	2.90
b	0.50	0.60	0.75
b1	1.10	1.20	1.35
b2	1.50	1.60	1.75
b3	1.20	1.30	1.45
b4	1.60	1.70	1.85
c	0.55	0.60	0.75
D	14.80	15.00	15.20
E	9.96	10.16	10.36
e		2.55	
e1		5.10	
H1	6.50	6.70	6.90
L	12.70	13.20	13.70
L1	1.60	1.80	2.00
L2	0.80	1.00	1.20
L3	0.60	0.80	1.00
ØP1	3.30	3.50	3.70
ØP2	2.99	3.19	3.39
Q	2.50	2.70	2.90
Ø1		5°	
Ø2		4°	
Ø3		10°	
Ø4		5°	
Ø5		5°	

Packing Options

Part Number	Marking	Packing Mode	M.O.Q
DSTF20120C	DSTF20120C	50pcs / Tube	1000

Tube Specification

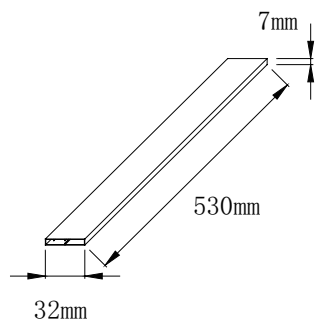

Part Numbering and Marking System

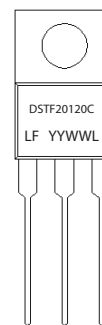

- DST = Device Type
- F = Package type
- 20 = Forward Current (20A)
- 120 = Reverse Voltage (120V)
- C = Configuration
- LF = Littelfuse
- YY = Year
- WW = Week
- L = Lot Number

单击下面可查看定价，库存，交付和生命周期等信息

[>>Littelfuse\(美国力特\)](#)