

**SP0524P Series 0.5pF Diode Array**

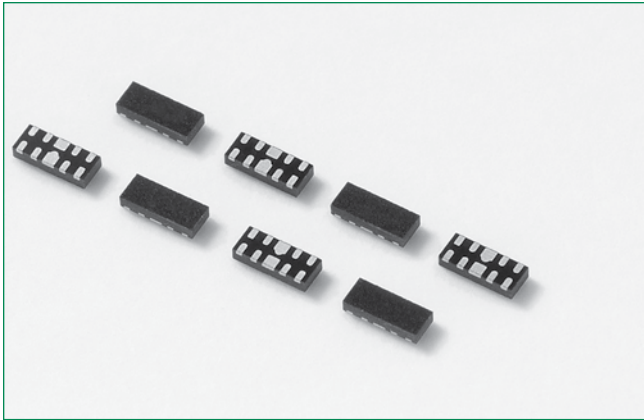

**OBSOLETE** DATE: 6/10/2020 PCN/ECN# ESU270-51  
REPLACED BY: SP1004U-ULC-04UTG



**Pinout**

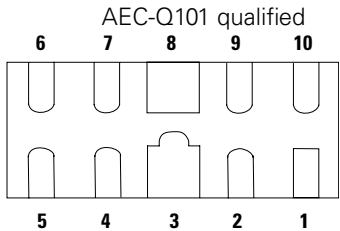

\*Pins 6, 7, 9, 10 are not internally connected but should be connected to the trace.

**Functional Block Diagram**

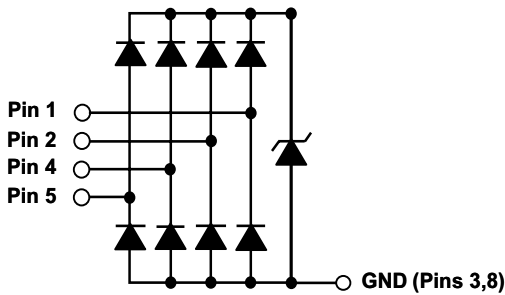

Life Support Note:

**Not Intended for Use in Life Support or Life Saving Applications**

The products shown herein are not designed for use in life sustaining or life saving applications unless otherwise expressly indicated.

**Description**

The SP0524P integrates 4 channels of ultra low capacitance rail-to-rail diodes and an additional zener diode to provide protection for electronic equipment that may experience destructive electrostatic discharges (ESD). This robust component can safely absorb repetitive ESD strikes above the maximum level specified in IEC 61000-4-2 international standard ( $\pm 8\text{kV}$  contact discharge) without performance degradation. The extremely low loading capacitance also makes it ideal for protecting high speed signal pins such as HDMI, USB3.0, USB2.0, and IEEE 1394.

**Features**

- ESD, IEC 61000-4-2,  $\pm 12\text{kV}$  contact,  $\pm 25\text{kV}$  air
- EFT, IEC 61000-4-4, 40A ( $t_p=5/50\text{ns}$ )
- Lightning, IEC 61000-4-5 2nd edition, 4A ( $t_p=8/20\mu\text{s}$ )
- Low capacitance of 0.5pF (TYP) per I/O
- Low leakage current of  $1.5\mu\text{A}$  (MAX) at 5V
- Small form factor  $\mu\text{DFN}$  (JEDEC MO-229) package saves board space
- AEC-Q101 qualified ( $\mu\text{DFN}$ -10 package)

**Applications**

- LCD/PDP TVs
- External Storages
- DVD/ Blue-Ray Players
- Desktops
- MP3/PMP
- Set Top Boxes
- Mobile Phones
- Notebooks
- Digital Cameras

**Application Example for USB3.0**

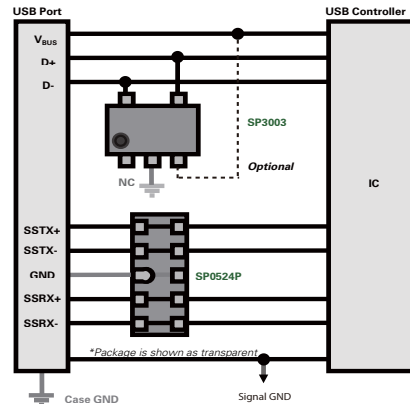

**Absolute Maximum Ratings**

Symbol	Parameter	Value	Units
$I_{PP}$	Peak Current ( $t_p=8/20\mu s$ )	4.0	A
$T_{OP}$	Operating Temperature	-40 to 125	°C
$T_{STOR}$	Storage Temperature	-55 to 150	°C

CAUTION: Stresses above those listed in "Absolute Maximum Ratings" may cause permanent damage to the component. This is a stress only rating and operation of the component at these or any other conditions above those indicated in the operational sections of this specification is not implied.

**Electrical Characteristics ( $T_{OP}=25^\circ C$ )**

Parameter	Symbol	Test Conditions	Min	Typ	Max	Units
Reverse Standoff Voltage	$V_{RWM}$	$I_R \leq 1\mu A$			5.0	V
Breakdown Voltage	$V_{BR}$	$I_R = 1mA$	6	6.5		V
Reverse Leakage Current	$I_{LEAK}$	$V_R=5V$ , Any I/O to GND			1.5	$\mu A$
Clamp Voltage <sup>1</sup>	$V_C$	$I_{PP}=1A$ , $t_p=8/20\mu s$ , Fwd		6.6		V
		$I_{PP}=2A$ , $t_p=8/20\mu s$ , Fwd		7.0		V
Dynamic Resistance	$R_{DYN}$	$(V_{C2} - V_{C1}) / (I_{PP2} - I_{PP1})$		0.4		$\Omega$
ESD Withstand Voltage <sup>1</sup>	$V_{ESD}$	IEC 61000-4-2 (Contact)	$\pm 12$			kV
		IEC 61000-4-2 (Air)	$\pm 25$			kV
Diode Capacitance <sup>1</sup>	$C_{I/O-GND}$	Reverse Bias=0V, f=1 MHz		0.5	0.55	pF
Diode Capacitance <sup>1</sup>	$C_{I/O-I/O}$	Reverse Bias=0V, f=1 MHz		0.3		pF

Note: <sup>1</sup> Parameter is guaranteed by design and/or component characterization.

**Capacitance vs. Bias Voltage**

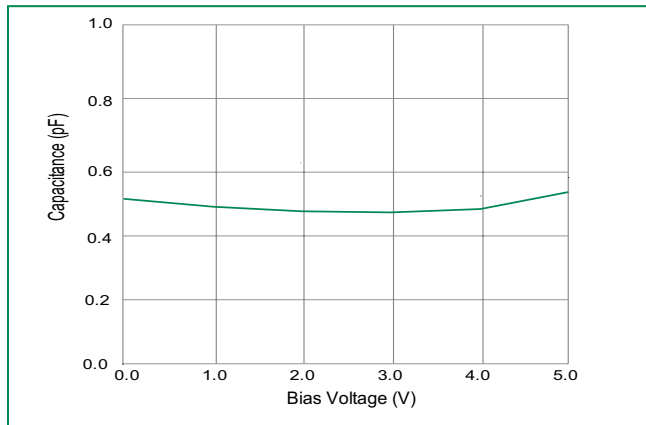

**Insertion Loss (S21) I/O to GND**

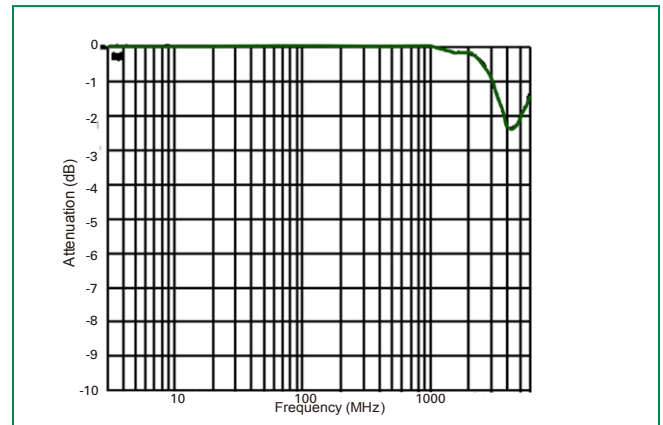

**Clamping Voltage vs.  $I_{PP}$**

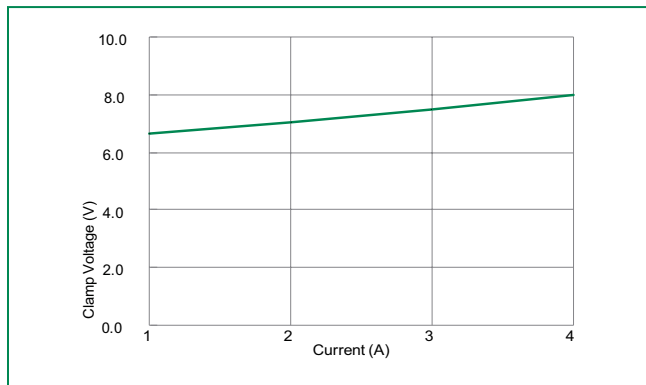

**8/20 $\mu s$  Pulse Waveform**

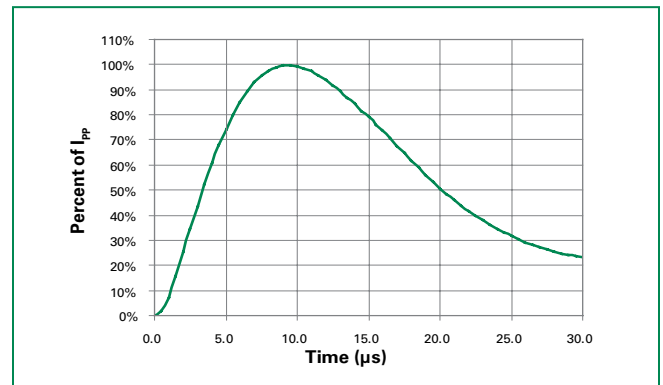

### Soldering Parameters

Reflow Condition		Pb – Free assembly
Pre Heat	- Temperature Min ( $T_{s(min)}$ )	150°C
	- Temperature Max ( $T_{s(max)}$ )	200°C
	- Time (min to max) ( $t_s$ )	60 – 180 secs
Average ramp up rate (Liquidus) Temp ( $T_L$ ) to peak		3°C/second max
$T_{s(max)}$ to $T_L$ - Ramp-up Rate		3°C/second max
Reflow	- Temperature ( $T_L$ ) (Liquidus)	217°C
	- Temperature ( $t_L$ )	60 – 150 seconds
Peak Temperature ( $T_p$ )		260 <sup>+0/-5</sup> °C
Time within 5°C of actual peak Temperature ( $t_p$ )		20 – 40 seconds
Ramp-down Rate		6°C/second max
Time 25°C to peak Temperature ( $T_p$ )		8 minutes Max.
Do not exceed		260°C

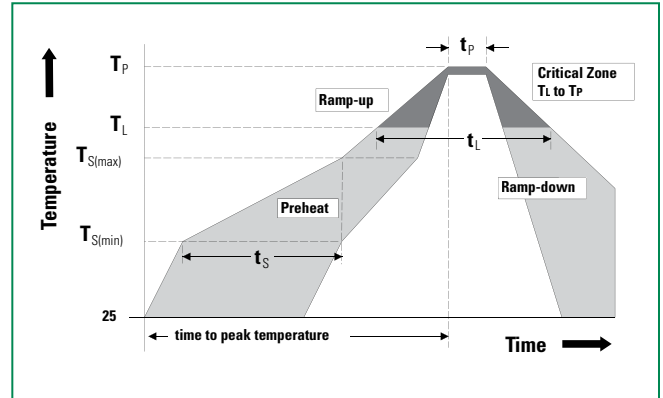

### Part Numbering System

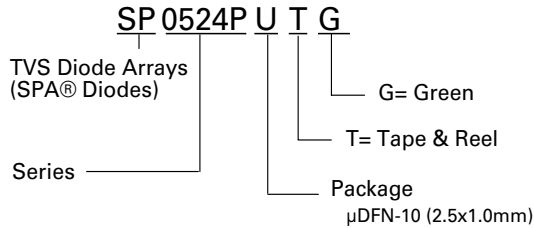

### Part Marking System

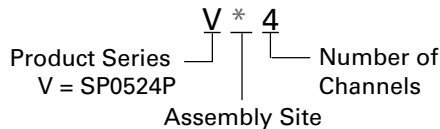

### Ordering Information

Part Number	Package	Marking	Min. Order Qty.
SP0524PUTG	$\mu$ DFN-10	V*4	3000

### Product Characteristics

<b>Lead Plating</b>	Pre-Plated Frame
<b>Lead Material</b>	Copper Alloy
<b>Lead Coplanarity</b>	0.004 inches(0.102mm)
<b>Substrate material</b>	Silicon
<b>Body Material</b>	Molded Compound
<b>Flammability</b>	UL Recognized compound meeting flammability rating V-0

Notes :

1. All dimensions are in millimeters
2. Dimensions include solder plating.
3. Dimensions are exclusive of mold flash & metal burr.

**Package Dimensions —  $\mu$ DFN-10 (2.5x1.0x0.5mm)**

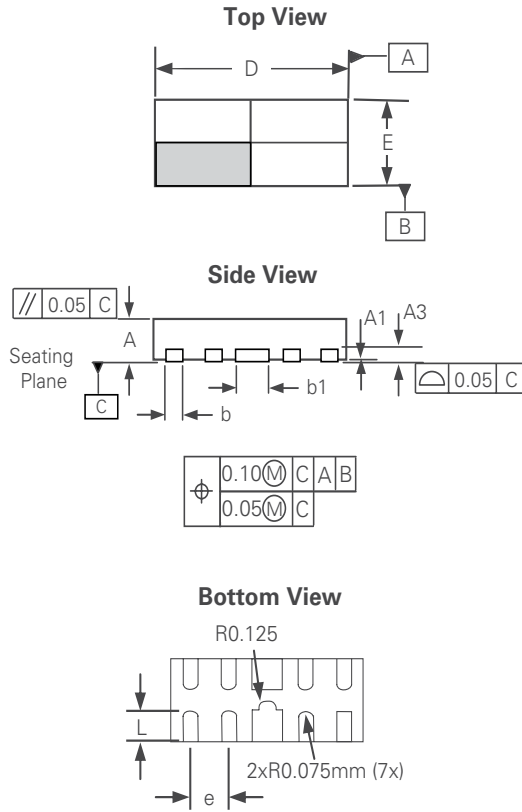

Package	$\mu$ DFN-10 (2.5x1.0x0.5mm)					
JEDEC	MO-229					
Symbol	Millimeters			Inches		
	Min	Nom	Max	Min	Nom	Max
<b>A</b>	0.48	0.515	0.55	0.019	0.020	0.021
<b>A1</b>	0.00	--	0.05	0.000		0.022
<b>A3</b>	0.125 Ref			0.005 Ref		
<b>b</b>	0.15	0.20	0.25	0.006	0.008	0.012
<b>b1</b>	0.35	0.40	0.45	0.014	0.016	0.018
<b>D</b>	2.40	2.50	2.60	0.094	0.098	0.102
<b>E</b>	0.90	1.00	1.10	0.035	0.039	0.043
<b>e</b>	0.50 BSC			0.020 BSC		
<b>L</b>	0.30	0.365	0.43	0.012	0.014	0.016

Soldering Pad Layout Dimensions		
	Inch	Millimeter
<b>C</b>	(0.034)	(0.875)
<b>G</b>	0.008	0.20
<b>P</b>	0.020	0.50
<b>P1</b>	0.039	1.00
<b>X</b>	0.008	0.20
<b>X1</b>	0.016	0.40
<b>Y</b>	0.027	0.675
<b>Y1</b>	(0.061)	(1.55)
<b>Z</b>	0.061	1.55

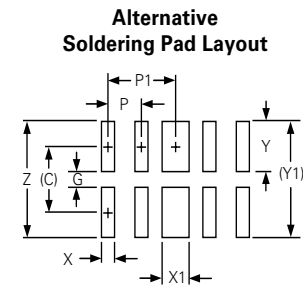
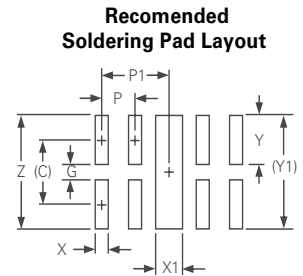

**Embossed Carrier Tape & Reel Specification —  $\mu$ DFN-10**

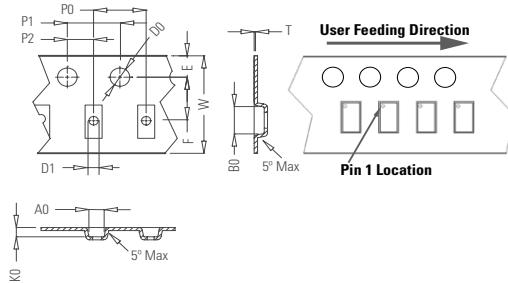

Package	$\mu$ DFN-10 (2.5x1.0x0.5mm)
Symbol	Millimeters
<b>A0</b>	1.30 +/- 0.10
<b>B0</b>	2.83 +/- 0.10
<b>D0</b>	Ø 1.50 + 0.10
<b>D1</b>	Ø 1.00 + 0.25
<b>E</b>	1.75 +/- 0.10
<b>F</b>	3.50 +/- 0.05
<b>K0</b>	0.65 +/- 0.10
<b>P0</b>	4.00 +/- 0.10
<b>P1</b>	4.00 +/- 0.10
<b>P2</b>	2.00 +/- 0.05
<b>T</b>	0.254 +/- 0.02
<b>W</b>	8.00 + 0.30 /- 0.10

单击下面可查看定价，库存，交付和生命周期等信息

[>>Littelfuse\(美国力特\)](#)