

SP05 Series - 30pF 30kV Unidirectional TVS Array

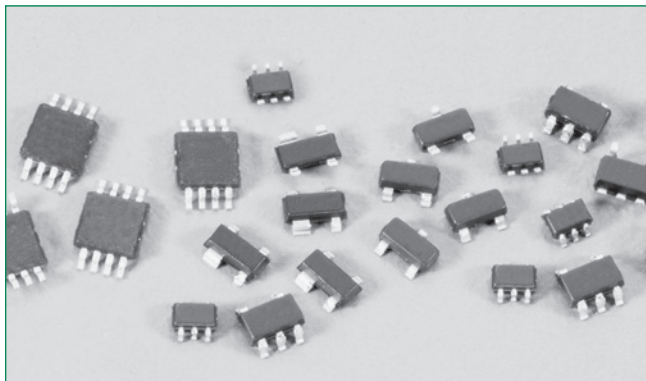

Pinout

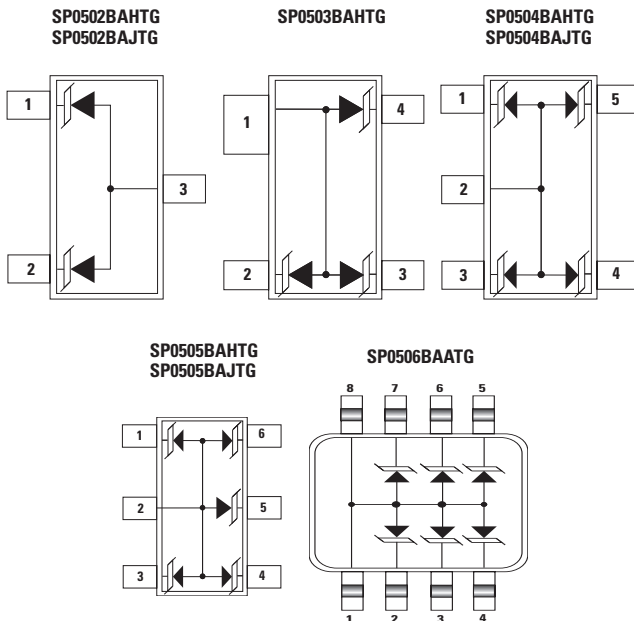

Description

This surface mount family of arrays suppress ESD and other transient overvoltage events. Used to meet the International Electrotechnical Compatibility (IEC transient immunity standards IEC 61000-4-2 for Electrostatic Discharge Requirements), these components can help protect sensitive digital or analog input circuits on data, signal, or control lines with voltage levels up to 5VDC.

The monolithic silicon arrays are comprised of specially designed structures for transient voltage suppression (TVS). The size and shape of these structures have been tailored for transient protection. Compared to MOVs, this diode array provides a lower clamping voltage and lower off-state capacitance.

Features

- An Array of 2, 3, 4, 5 or 6 TVS Avalanche Diodes in a ultra small SC70, SOT-23, SOT-143 or MSOP packages
- ESD Capability Standards
 - IEC 61000-4-2, Direct Discharge 30kV (Level 4)
 - IEC 61000-4-2, Air Discharge..... 30kV (Level 4)
 - MIL STD 883 3015.7.....30kV
- Input Protection for Applications Up to 5VDC
- Fast Response Time <1ns
- Low Input Capacitance.....30pF Typical
- Operating Temperature Range.....-40°C to 125°C
- Moisture Sensitivity Level (MSL:1)

Applications

- Mobile phone handsets
- Personal Digital Assistants (PDA)
- Portable handheld equipment (Laptop, Palmtop computers)
- Computer port, keyboard (USB1.1)
- Digital still cameras
- Digital video cameras
- MP3 players

Additional Information



Datasheet



Resources



Samples

Life Support Note:

Not Intended for Use in Life Support or Life Saving Applications

The products shown herein are not designed for use in life sustaining or life saving applications unless otherwise expressly indicated.

Absolute Maximum Ratings

Symbol	Parameter	Rating	Units
P_{PK}	Peak Pulse Power ($t_p=8/20\mu s$)	25	W
I_{PP}	Peak Pulse Current ($t_p=8/20\mu s$)	3	A
T_{OP}	Operating Temperature	-40 to 125	°C
T_{STOR}	Storage Temperature	-55 to 150	°C

CAUTION: Stresses above those listed in "Absolute Maximum Ratings" may cause permanent damage to the component. This is a stress only rating and operation of the component at these or any other conditions above those indicated in the operational sections of this specification is not implied.

Electrical Characteristics $T_A = +25^\circ C$, Unless Otherwise Specified

Parameter	Test Conditions	Min	Typ	Max	Units
Reverse Standoff Voltage	$I_R \leq 1\mu A$			5.5	V
Reverse Standoff Leakage Current	$V = 5.0V$		1	100	nA
Signal Clamp Voltage					
Positive	$I = 1mA$	6.0		8.5	V
Negative	$I = 10mA$	-1.2	-0.8	-0.4	V
Clamp Voltage during ESD					
MILSTD-883 Method 3015 (HBM) test					
+ 8kV			12		V
- 8kV			-8		V
ESD Test Level (1)					-
IEC-61000-4-2, Contact discharge		30			kV
MILSTD-883 Method 3015 (HBM)		30			kV
Capacitance	2.5V @ 1MHz		30		pF
Turn on/off Time			<1		ns
Diode Dynamic Resistance					-
Forward Conduction			1.0		Ω
Reverse Conduction			1.4		Ω

Note:

1. ESD voltage applied between channel pins and ground, one pin at a time; all other channel pins are open; all ground pins are grounded.

Typical Diode Capacitance vs. Reverse Voltage

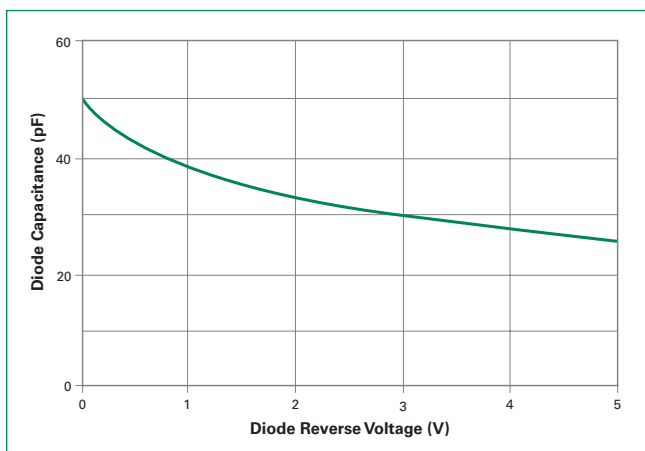

Soldering Parameters

Reflow Condition		Pb – Free assembly
Pre Heat	- Temperature Min ($T_{s(min)}$)	150°C
	- Temperature Max ($T_{s(max)}$)	200°C
	- Time (min to max) (t_s)	60 – 180 secs
Average ramp up rate (Liquidus) Temp (T_L) to peak		5°C/second max
$T_{s(max)}$ to T_L - Ramp-up Rate		5°C/second max
Reflow	- Temperature (T_L) (Liquidus)	217°C
	- Temperature (t_L)	60 – 150 seconds
Peak Temperature (T_p)		260 ^{+0/5} °C
Time within 5°C of actual peak Temperature (t_p)		20 – 40 seconds
Ramp-down Rate		5°C/second max
Time 25°C to peak Temperature (T_p)		8 minutes Max.
Do not exceed		260°C

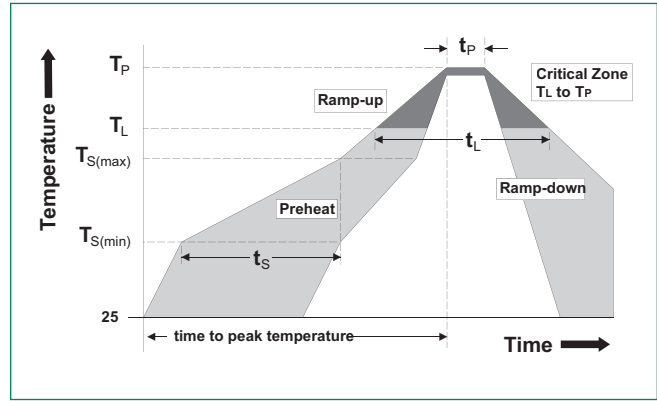

Package Dimensions – SOT143

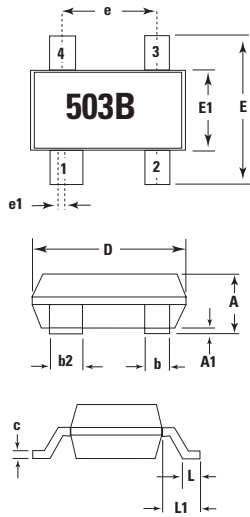

SP0503BAHTG - SOT143-4
Recommended Pad Layout

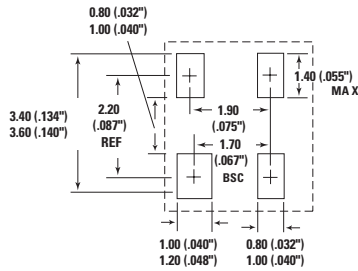

Package	SOT143-4			
Pins	4			
JEDEC	TO-253			
Symbol	Millimeters		Inches	
	Min	Max	Min	Max
A	0.8	1.22	0.03	0.048
A1	0.05	0.15	0.002	0.006
b	0.30	0.50	0.012	0.020
b2	0.76	0.89	0.030	0.035
c	0.08	0.20	0.003	0.008
D	2.80	3.04	0.110	0.120
E	2.10	2.64	0.082	0.104
E1	1.20	1.40	0.047	0.055
e	1.92 BSC		0.076 BSC	
e1	0.20 BSC		0.008 BSC	
L	0.4	0.6	0.016	0.024
L1	0.550 REF		0.022 REF	

Package Dimensions — SC70

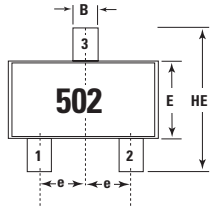

SP0502BAJTG - SC70-3

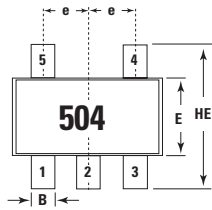
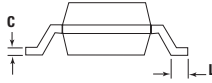
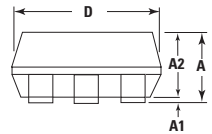

SP0504BAJTG - SC70-5

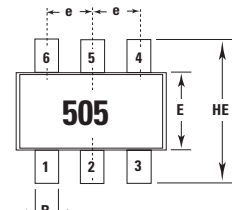
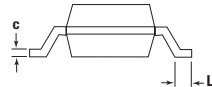
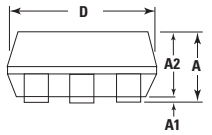

SP0505BAJTG - SC70-6

Recommended Pad Layout

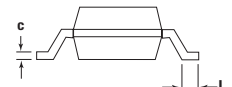
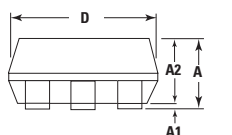
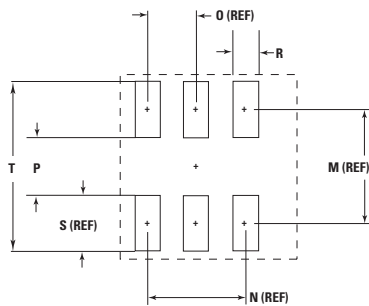

Package	SC70-3			
Pins	3			
JEDEC	MO-203			
Symbol	Millimeters		Inches	
	Min	Max	Min	Max
A	0.80	1.10	0.031	0.043
A1	0.00	0.10	0.00	0.004
A2	0.70	1.00	0.028	0.039
B	0.15	0.30	0.006	0.012
c	0.08	0.25	0.003	0.010
D	1.85	2.25	0.073	0.089
E	1.15	1.35	0.045	0.053
e	0.66 BSC		0.026 BSC	
HE	2.00	2.40	0.079	0.094
L	0.26	0.46	0.010	0.018

Package	SC70-5			
Pins	5			
JEDEC	MO-203			
Symbol	Millimeters		Inches	
	Min	Max	Min	Max
A	0.80	1.10	0.031	0.043
A1	0.00	0.10	0.00	0.004
A2	0.70	1.00	0.028	0.039
B	0.15	0.30	0.006	0.012
c	0.08	0.25	0.003	0.010
D	1.85	2.25	0.073	0.089
E	1.15	1.35	0.045	0.053
e	0.65 BSC		0.026 BSC	
HE	2.00	2.40	0.079	0.094
L	0.26	0.46	0.010	0.018

Package	SC70-6			
Pins	6			
JEDEC	MO-203			
Symbol	Millimeters		Inches	
	Min	Max	Min	Max
A	0.80	1.10	0.031	0.043
A1	0.00	0.10	0.00	0.004
A2	0.70	1.00	0.028	0.039
B	0.15	0.30	0.006	0.012
c	0.08	0.25	0.003	0.010
D	1.85	2.25	0.073	0.089
E	1.15	1.35	0.045	0.053
e	0.65 BSC		0.026 BSC	
HE	2.00	2.40	0.079	0.094
L	0.26	0.46	0.010	0.018
M	-	1.60	-	0.063
N	-	1.30	-	0.051
O	-	0.65	-	0.026
P	-	0.70	-	0.028
R	-	0.35	-	0.014
S	-	0.90	-	0.035
T	-	2.50	-	0.098

Package Dimensions — SOT23

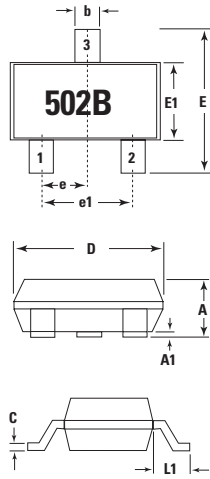

SP0502BAHTG - SOT23-3

Recommended Pad Layout

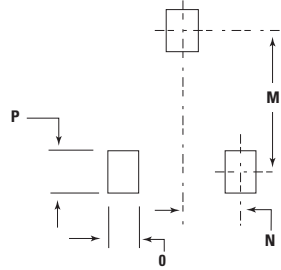

Package	SOT23-3			
Pins	3			
JEDEC	TO-236			
Symbol	Millimeters		Inches	
	Min	Max	Min	Max
A	0.89	1.12	0.035	0.044
A1	0.01	0.1	0.0004	0.004
b	0.3	0.5	0.012	0.020
c	0.08	0.2	0.003	0.008
D	2.8	3.04	0.110	0.120
E	2.1	2.64	0.083	0.104
E1	1.2	1.4	0.047	0.055
e	0.95 BSC		0.038 BSC	
e1	1.90 BSC		0.075 BSC	
L1	0.54 REF		0.021 REF	
M		2.29		0.090
N		0.95		0.038
O		0.78		0.030TYP
P		0.78		0.030TYP

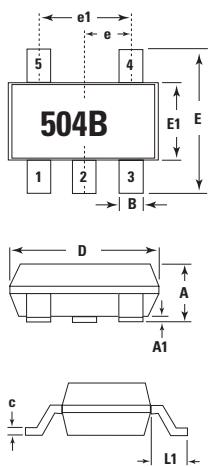

SP0504BAHTG - SOT23-5

Recommended Pad Layout

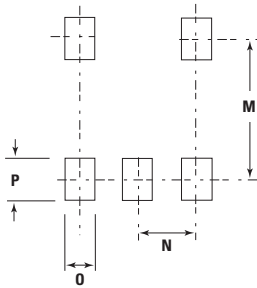

Package	SOT23-5			
Pins	5			
JEDEC	MO-178			
Symbol	Millimeters		Inches	
	Min	Max	Min	Max
A	-	1.45	-	0.057
A1	0	0.15	0	0.006
b	0.3	0.5	0.012	0.020
c	0.08	0.22	0.003	0.009
D	2.75	3.05	0.108	0.120
E	2.6	3.0	0.102	0.118
E1	1.45	1.75	0.057	0.069
e	0.95 BSC		0.038 BSC	
e1	1.90 BSC		0.075 BSC	
L1	0.60 REF		0.024 REF	
M		2.59		.102
N		0.95		.038
O		0.69		.027TYP
P		0.99		.039TYP

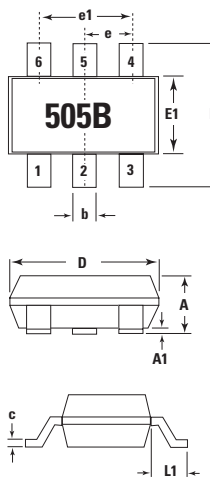

SP0505BAHTG - SOT23-6

Recommended Pad Layout

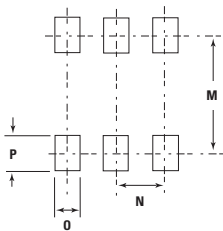

Package	SOT23-6			
Pins	6			
JEDEC	MO-178			
Symbol	Millimeters		Inches	
	Min	Max	Min	Max
A	-	1.45	-	0.057
A1	0	0.15	0	0.006
b	0.3	0.5	0.012	0.020
c	0.08	0.22	0.003	0.009
D	2.75	3.05	0.108	0.120
E	2.6	3.0	0.102	0.118
E1	1.45	1.75	0.057	0.069
e	0.95 BSC		0.038 BSC	
e1	1.90 BSC		0.075 BSC	
L1	0.60 REF		0.024 REF	
M		2.59		.102
N		0.95		0.038
O		0.69		.027TYP
P		0.99		.039TYP

Package Dimensions — MSOP

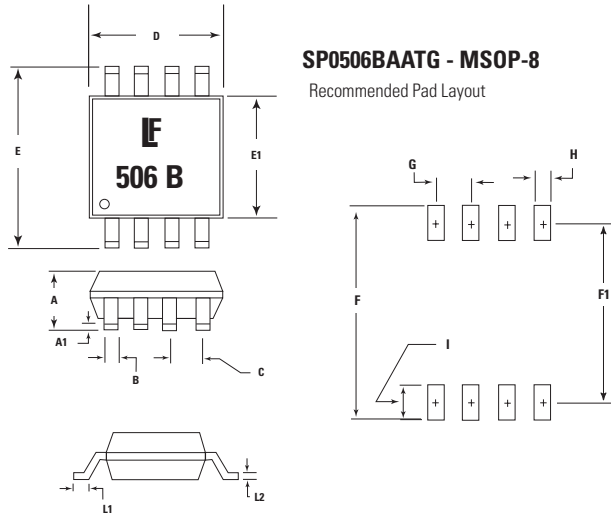

Package	MSOP			
Pins	8			
JEDEC	MO-187			
Symbol	Millimeters		Inches	
	Min	Max	Min	Max
D	2.90	3.10	0.114	.122
E	4.78	4.98	.188	.196
E1	2.90	3.10	.114	.122
A	0.87	1.17	.034	.046
A1	0.05	0.25	.002	.010
B	-	0.30TYP	-	0.012TYP
C	-	0.65TYP	-	0.026TYP
L1	0.52	0.54	0.020	0.021
L2	-	0.18TYP	-	.007TYP
F	-	5.28	-	.208
F1	-	4.24	-	.167
G	-	0.65	-	0.026
H	-	0.38	-	.015
I	-	1.04	-	.041

Part Numbering System

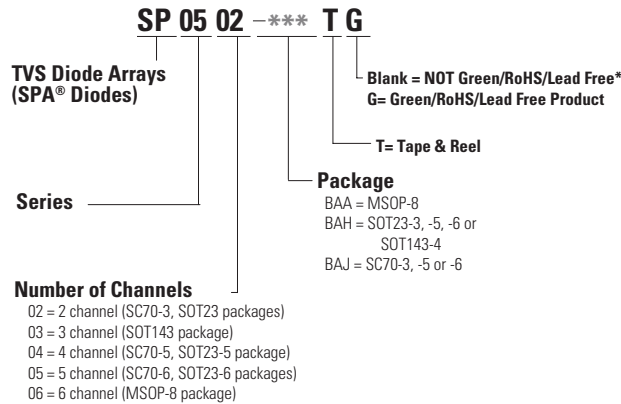

Product Characteristics

Lead Plating	"G" Green version - Matte Tin (Sn)
Lead Material	Copper / Iron Alloy
Lead Coplanarity	0.004 inches (0.102mm)
Substrate Material	Silicon
Body Material	Molded Compound
Flammability	UL Recognized compound meeting flammability rating V-0

Notes:

- All dimensions are in millimeters.
- Dimensions include solder plating.
- Dimensions are exclusive of mold flash & metal burr.
- Blo is facing up for mold and facing down for trim/form, i.e. reverse trim/form.
- Package surface matte finish VDI 11-13.

Ordering Information

Part Number	CH	Package Type	Quantity Per Reel
SP0502BAHTG	2	SOT23-3	3000
SP0503BAHTG	3	SOT143-4	3000
SP0504BAHTG	4	SOT23-5	3000
SP0505BAHTG	5	SOT23-6	3000
SP0506BAATG	6	MSOP-8	4000
SP0502BAJTG	2	SC70-3	3000
SP0504BAJTG	4	SC70-5	3000
SP0505BAJTG	5	SC70-6	3000

*NOTE: To order NON-Green/RoHS/Lead Free version of product, remove "G" at the end of part number.

Embossed Carrier Tape & Reel Specification – SOT23-3

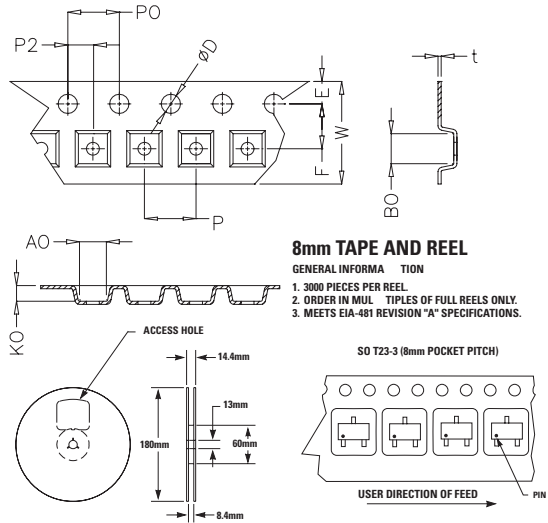

Symbol	Millimetres		Inches	
	Min	Max	Min	Max
E	1.65	1.85	0.065	0.073
F	3.40	3.60	0.134	0.142
P2	1.90	2.10	0.075	0.083
D	1.40	1.60	0.055	0.063
P0	3.90	4.10	0.154	0.161
W	7.70	8.30	0.303	0.327
P	3.90	4.10	0.154	0.161
A0	3.05	3.25	0.120	0.128
B0	2.67	2.87	0.105	0.113
K0	1.12	1.32	0.044	0.052
t	0.22	0.24	0.009	0.009

Embossed Carrier Tape & Reel Specification – SOT23-5

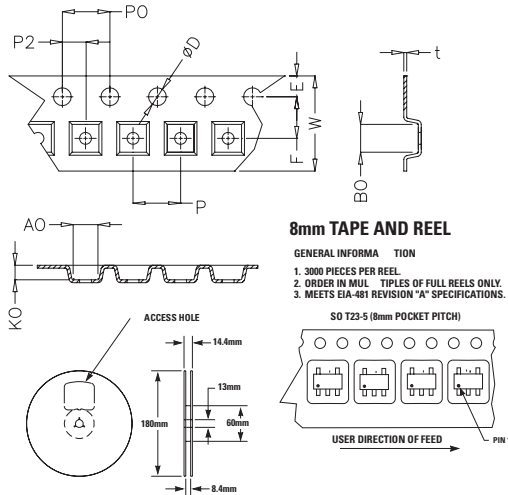

Symbol	Millimetres		Inches	
	Min	Max	Min	Max
E	1.65	1.85	0.065	0.073
F	3.40	3.60	0.134	0.142
P2	1.90	2.10	0.075	0.083
D	1.40	1.60	0.055	0.063
P0	3.90	4.10	0.154	0.161
W	7.70	8.30	0.303	0.327
P	3.90	4.10	0.154	0.161
A0	3.05	3.25	0.120	0.128
B0	2.67	2.87	0.105	0.113
K0	1.12	1.32	0.044	0.052
t	0.22	0.24	0.009	0.009

Embossed Carrier Tape & Reel Specification – SOT23-6

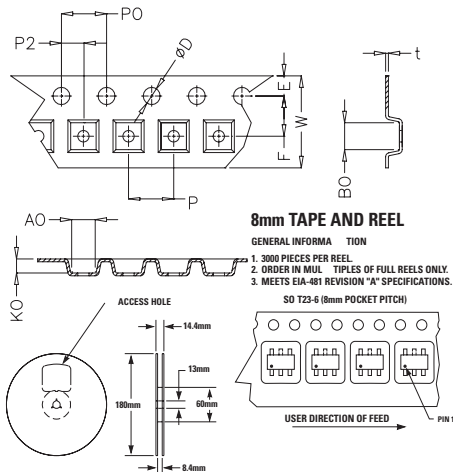

Symbol	Millimetres		Inches	
	Min	Max	Min	Max
E	1.65	1.85	0.065	0.073
F	3.40	3.60	0.134	0.142
P2	1.90	2.10	0.075	0.083
D	1.40	1.60	0.055	0.063
P0	3.90	4.10	0.154	0.161
W	7.70	8.30	0.303	0.327
P	3.90	4.10	0.154	0.161
A0	3.05	3.25	0.120	0.128
B0	2.67	2.87	0.105	0.113
K0	1.12	1.32	0.044	0.052
t	0.22	0.24	0.009	0.009

Embossed Carrier Tape & Reel Specification – SOT143-4

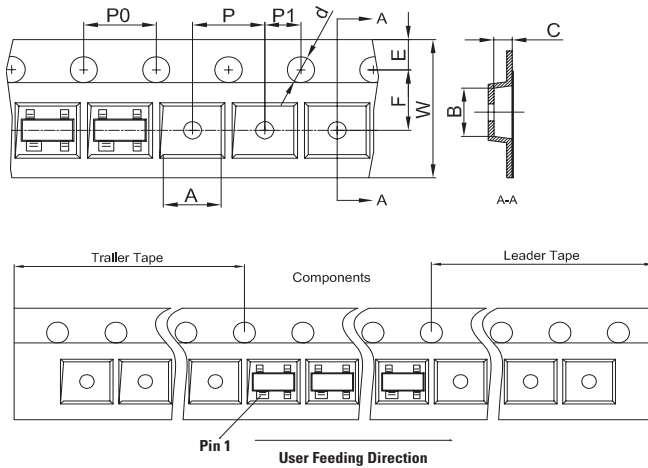

Symbol	Millimetres		Inches	
	Min	Max	Min	Max
A	3.09	3.09	0.122	0.130
B	2.70	2.90	1.106	0.114
C	1.21	1.41	0.048	0.056
d	1.40	1.60	0.055	0.102
E	1.65	0.85	0.065	0.073
F	3.45	3.65	0.133	0.142
P0	4.10	3.90	0.154	0.161
P	4.10	3.90	0.154	0.161
P1	1.90	2.10	0.075	0.083
W	7.90	8.10	0.311	0.319

Embossed Carrier Tape & Reel Specification – MSOP-8

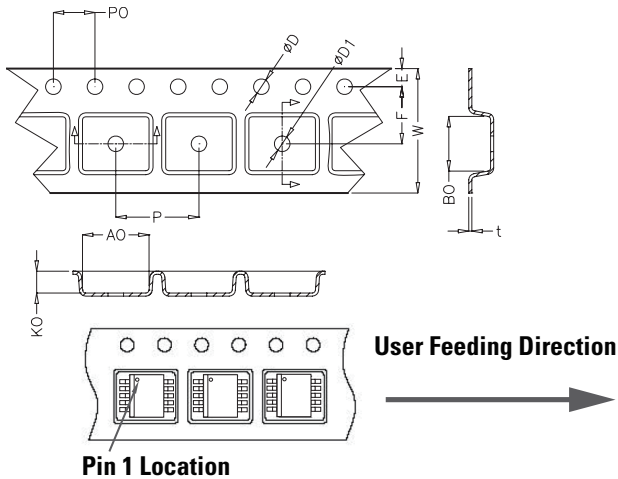

Symbol	Millimetres		Inches	
	Min	Max	Min	Max
E	1.65	1.85	0.065	0.073
F	5.40	5.60	0.213	0.220
D	1.50	1.60	0.059	0.063
D1	1.50 Min		0.059 Min	
P0	3.90	4.10	0.154	0.161
W	11.70	12.30	0.461	0.484
P	7.90	8.10	0.311	0.319
A0	5.20	5.40	0.205	0.213
B0	3.30	3.40	0.126	0.134
K0	1.20	1.40	0.047	0.055
t	0.30 ± 0.05		0.012 ± 0.002	

Embossed Carrier Tape & Reel Specification – SC70-3

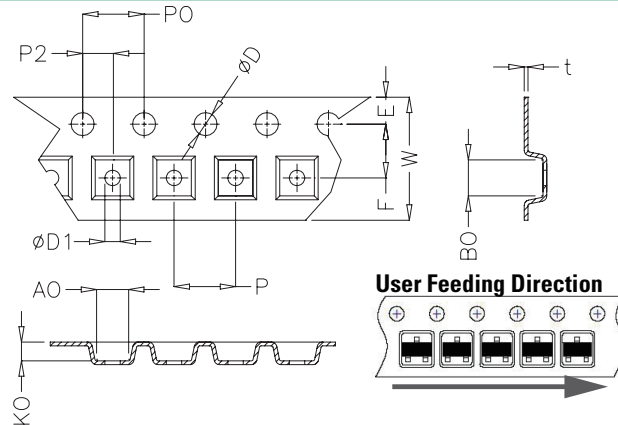

Symbol	Millimetres		Inches	
	Min	Max	Min	Max
E	1.65	1.85	0.064	0.073
F	3.45	3.55	0.135	0.139
P2	1.95	2.05	0.077	0.081
D	1.40	1.60	0.055	0.063
D1	1.00	1.25	0.039	0.049
P0	3.90	4.10	0.154	0.161
W	7.70	8.10	0.303	0.318
P	3.90	4.10	0.153	0.161
A0	2.14	2.34	0.084	0.092
B0	2.24	2.44	0.088	0.096
K0	1.12	1.32	0.044	0.052
t	0.27 Max		0.010 Max	

Embossed Carrier Tape & Reel Specification – SC70-5

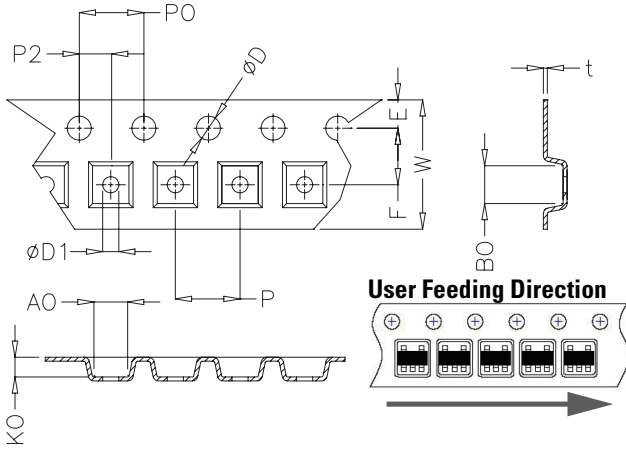

Symbol	Millimetres		Inches	
	Min	Max	Min	Max
E	1.65	1.85	0.064	0.073
F	3.45	3.55	0.135	0.139
P2	1.95	2.05	0.077	0.081
D	1.40	1.60	0.055	0.063
D1	1.00	1.25	0.039	0.049
P0	3.90	4.10	0.154	0.161
W	7.70	8.10	0.303	0.318
P	3.90	4.10	0.153	0.161
A0	2.14	2.34	0.084	0.092
B0	2.24	2.44	0.088	0.096
K0	1.12	1.32	0.044	0.052
t	0.27 Max		0.010 Max	

Embossed Carrier Tape & Reel Specification – SC70--6

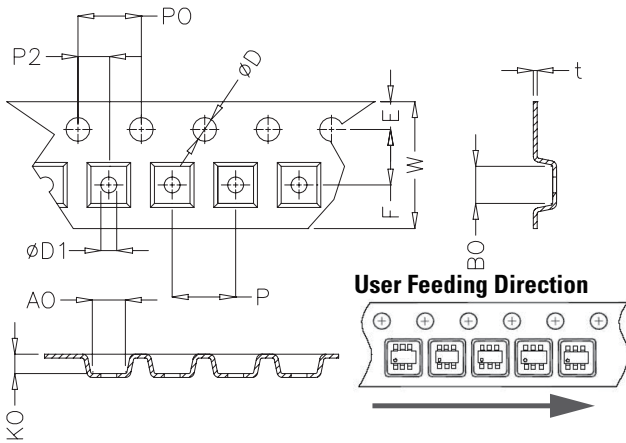

Symbol	Millimetres		Inches	
	Min	Max	Min	Max
E	1.65	1.85	0.064	0.073
F	3.45	3.55	0.135	0.139
P2	1.95	2.05	0.077	0.081
D	1.40	1.60	0.055	0.063
D1	1.00	1.25	0.039	0.049
P0	3.90	4.10	0.154	0.161
W	7.70	8.10	0.303	0.318
P	3.90	4.10	0.153	0.161
A0	2.14	2.34	0.084	0.092
B0	2.24	2.44	0.088	0.096
K0	1.12	1.32	0.044	0.052
t	0.27 Max		0.010 Max	

Disclaimer Notice - Littelfuse products are not designed for, and shall not be used for, any purpose (including, without limitation, automotive, military, aerospace, medical, life-saving, life-sustaining or nuclear facility applications, devices intended for surgical implant into the body, or any other application in which the failure or lack of desired operation of the product may result in personal injury, death, or property damage) other than those expressly set forth in applicable Littelfuse product documentation. Warranties granted by Littelfuse shall be deemed void for products used for any purpose not expressly set forth in applicable Littelfuse documentation. Littelfuse shall not be liable for any claims or damages arising out of products used in applications not expressly intended by Littelfuse as set forth in applicable Littelfuse documentation. The sale and use of Littelfuse products is subject to Littelfuse Terms and Conditions of Sale, unless otherwise agreed by Littelfuse. "Littelfuse" includes Littelfuse, Inc., and all of its affiliate entities. <http://www.littelfuse.com/disclaimer-electronics>

单击下面可查看定价，库存，交付和生命周期等信息

[>>Littelfuse\(美国力特\)](#)