

Single Phase Rectifier Bridge

$$I_{dAV} = 21 \text{ A}$$

$$V_{RRM} = 800-1800 \text{ V}$$

V_{RSM} V_{DSM} V	V_{RRM} V_{DRM} V	Type
800	800	VBO 22-08NO8
1200	1200	VBO 22-12NO8
1400	1400	VBO 22-14NO8
1600	1600	VBO 22-16NO8
1800	1800	VBO 22-18NO8

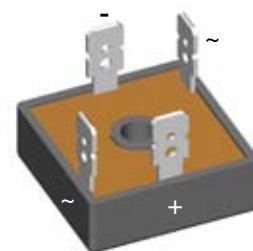
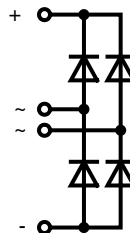

Symbol	Conditions	Maximum Ratings
I_{dAV}	$T_C = 85^\circ\text{C}$, module	17 A
I_{dAVM}	$T_C = 63^\circ\text{C}$, module	21 A
I_{FSM}	$T_{VJ} = 45^\circ\text{C}$; $t = 10 \text{ ms}$ (50 Hz)	380 A
	$V_R = 0$; $t = 8.3 \text{ ms}$ (60 Hz)	440 A
	$T_{VJ} = T_{VJM}$; $t = 10 \text{ ms}$ (50 Hz)	360 A
	$V_R = 0$; $t = 8.3 \text{ ms}$ (60 Hz)	400 A
I^2t	$T_{VJ} = 45^\circ\text{C}$; $t = 10 \text{ ms}$ (50 Hz)	725 A ² s
	$V_R = 0$; $t = 8.3 \text{ ms}$ (60 Hz)	800 A ² s
	$T_{VJ} = T_{VJM}$; $t = 10 \text{ ms}$ (50 Hz)	650 A ² s
	$V_R = 0$; $t = 8.3 \text{ ms}$ (60 Hz)	650 A ² s
T_{VJ}		-40...+150 °C
T_{VJM}		150 °C
T_{stg}		-40...+150 °C
V_{ISOL}	50/60 Hz, RMS $t = 1 \text{ min}$	2500 V~
	$I_{ISOL} \leq 1 \text{ mA}$ $t = 1 \text{ s}$	3000 V~
M_d	Mounting torque (M5) (10-32 UNF)	2 ±10% Nm
		18 ±10% lb.in.
Weight	Typ.	22 g

Features

- Package with ¼" fast-on terminals
- Isolation voltage 3000 V~
- Planar passivated chips
- Blocking voltage up to 1800 V
- Low forward voltage drop
- UL registered E 72873

Applications

- Supplies for DC power equipment
- Input rectifiers for PWM inverter
- Battery DC power supplies
- Field supply for DC motors

Advantages

- Easy to mount with one screw
- Space and weight savings
- Improved temperature & power cycling

Dimensions in mm (1 mm = 0.0394")

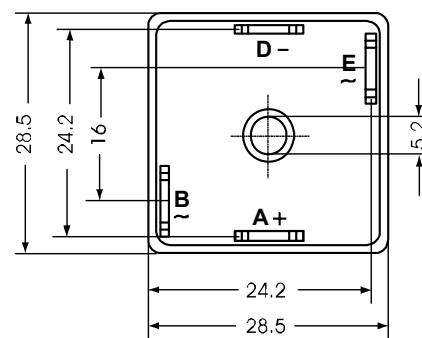
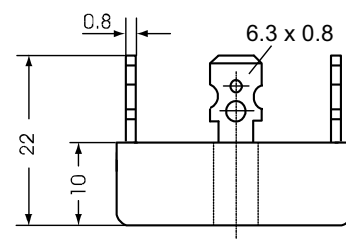

Symbol	Conditions	Characteristic Values
I_R	$V_R = V_{RRM}$ $T_{VJ} = 25^\circ\text{C}$	0.3 mA
		$T_{VJ} = T_{VJM}$ 5.0 mA
V_F	$I_F = 150 \text{ A}$ $T_{VJ} = 25^\circ\text{C}$	2.2 V
V_{TO}	For power-loss calculations only	0.85 V
r_t		12 mΩ
R_{thJC}	per diode; 120° el.	8.20 K/W
	per module	2.05 K/W
	per diode; 120° el.	9.40 K/W
R_{thCH}	per diode; 120° el.	2.35 K/W
	per module	
d_S	Creeping distance on surface	12.7 mm
d_A	Creepage distance in air	9.4 mm
a	Max. allowable acceleration	50 m/s ²

Data according to IEC 60747 and refer to a single diode unless otherwise stated.

IXYS reserves the right to change limits, test conditions and dimensions.

20081024a

© IXYS All rights reserved

1 - 2

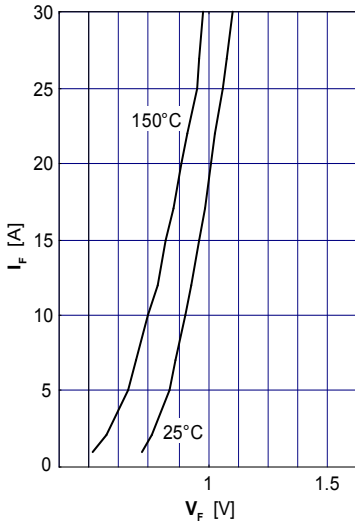

Fig. 1 Forward current versus voltage drop per diode

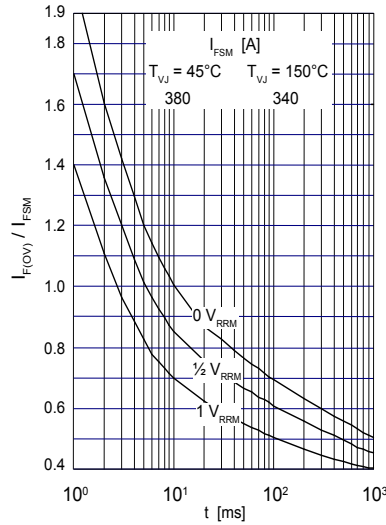

Fig. 2 Surge overload current per diode
 I_{FSM} : Crest value. t : duration

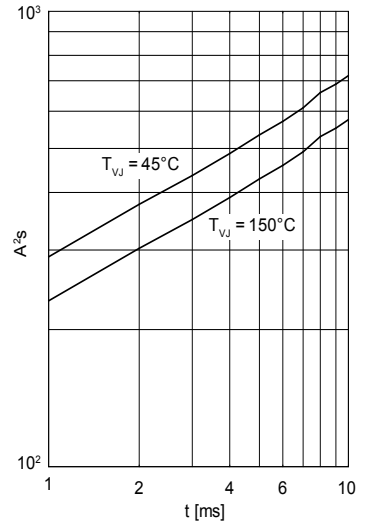

Fig. 3 I^2t versus time (1-10 ms) per diode or thyristor

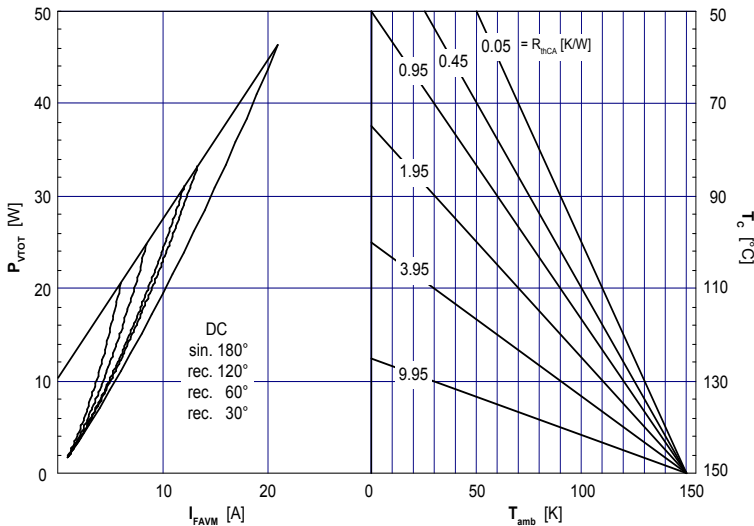

Fig. 4 Power dissipation vs. direct output current and ambient temperature

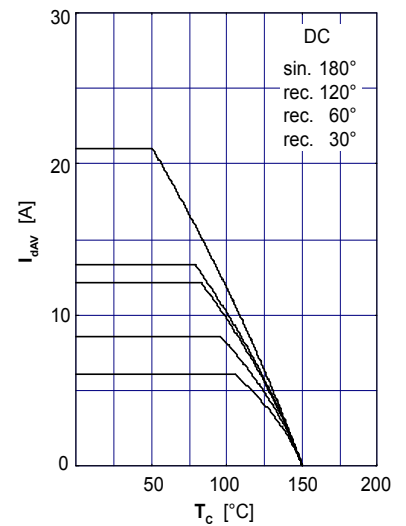

Fig. 5 Maximum forward current at case temperature

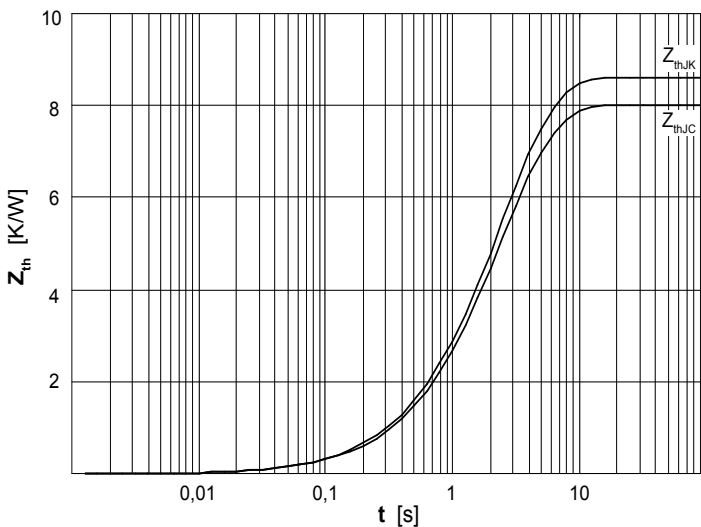

Fig. 6 Transient thermal impedance per diode or thyristor, calculated

IXYS reserves the right to change limits, test conditions and dimensions.

20081024a

© IXYS All rights reserved

2 - 2

单击下面可查看定价，库存，交付和生命周期等信息

[>>Littelfuse\(美国力特\)](#)