

POWR-GARD® Fuse Datasheet

SPNH SERIES SOLAR FUSE

1500 V dc • 50–400 A • NH Style



Description

The SPNH series has been designed to meet the emerging circuit protection needs for 1500 volt photovoltaic systems. These fuses provide full range protection for all potential overcurrent conditions that exist in PV applications. Suitable for PV inverter protection and array combiner applications.

Features/Benefits

- Compact NH XL sizes
- Low watt loss design
- 1500 V dc rating for high efficiency designs
- Designed to protect against a full range of overcurrents

Applications

- Inverters
- Re-combiner boxes
- Array/re-combiner application
- PV inverter dc input protection

Web Resources

- Download technical documents: Littelfuse.com/SPNH

Specifications

Voltage Rating	1500 V dc
Amperage Rating	50, 63, 80, 100, 125, 160, 200, 250, 315, 350, 400 A
Interrupting Rating	30 kA, 50 kA
Time Constant	≤ 2 ms
Material	Body: ceramic End Bells: copper alloy
Approvals	UL 248-19 Listed (File: E339112)
Applicable Standards	UL 248-1, 248-19 IEC 60269-6
Environmental	RoHS Compliant

Part Numbering System

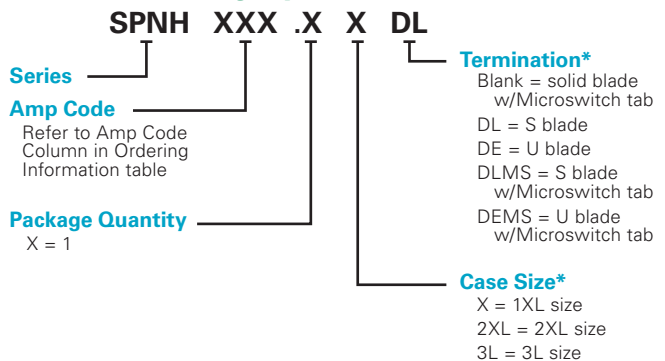

SERIES	AMP	PACKAGE QUANTITY	CATALOG NUMBER	ORDERING NUMBER
SPNH	50	1	SPNH050	SPNH050.X
SPNH	200	1	SPNH200	SPNH200.X
SPNH	400	1	SPNH400	SPNH400.XXDLMS

*Solid blade option for 1XL case size does not require a case or termination designator for the part number.

Recommended Accessories

1XL Case Size

Fuse Holder: LFNH152001CST

Fuse Terminal Covers: LFNH15200FBC

2XL Case Size

Fuse Holder: LFNH154001CST

Fuse Terminal Covers: LFNH15400FBC

3L Case Size

Fuse Holder: LFNH156301CST

Fuse Terminal Covers: LFNH15630FBC

Microswitch

MSSPNH1500X



Look for this logo to indicate products that are used in solar applications. Visit our website Littelfuse.com/solar for the latest updates on approvals, certifications, and new products.

Dimensions Millimeters (in)

Size: 1 XL w/ Microswitch Tab

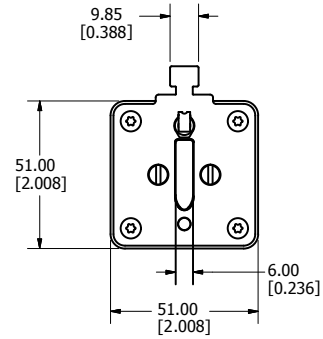
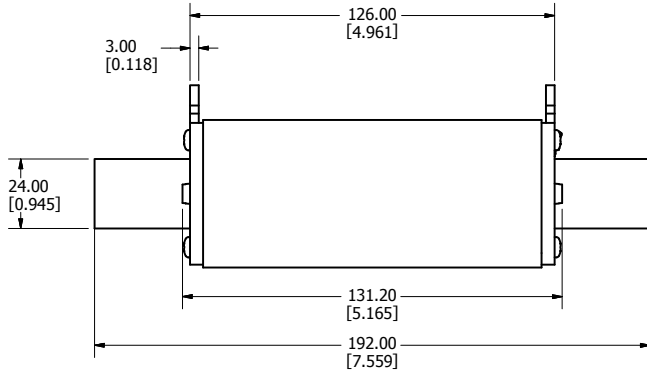

Size: 2 XL w/ Microswitch Tab

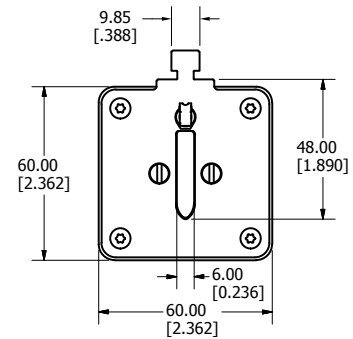
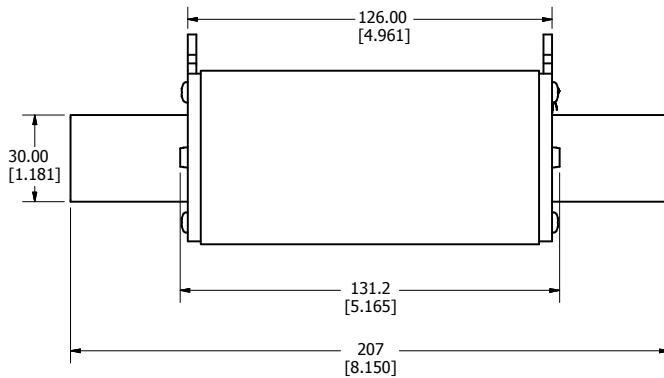

Size: 3 L w/ Microswitch Tab

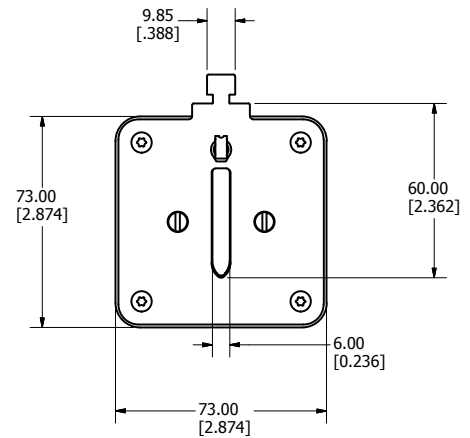
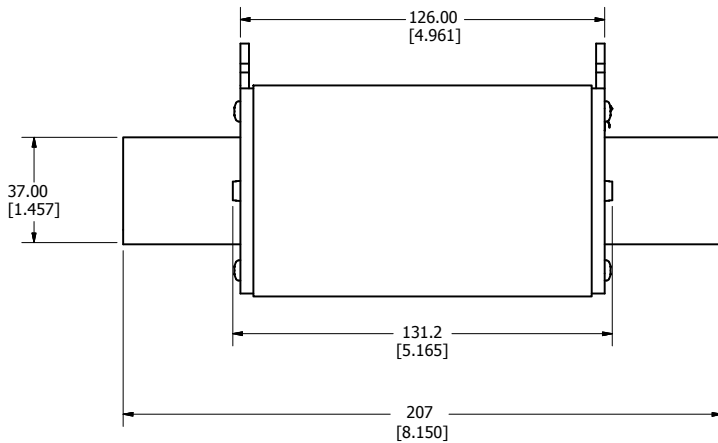

POWR-GARD® Fuse Datasheet

SPNH SERIES SOLAR FUSE

Dimensions Millimeters (in)

Size: 1XL DE Blade

Recommended Torque: 44 Nm*

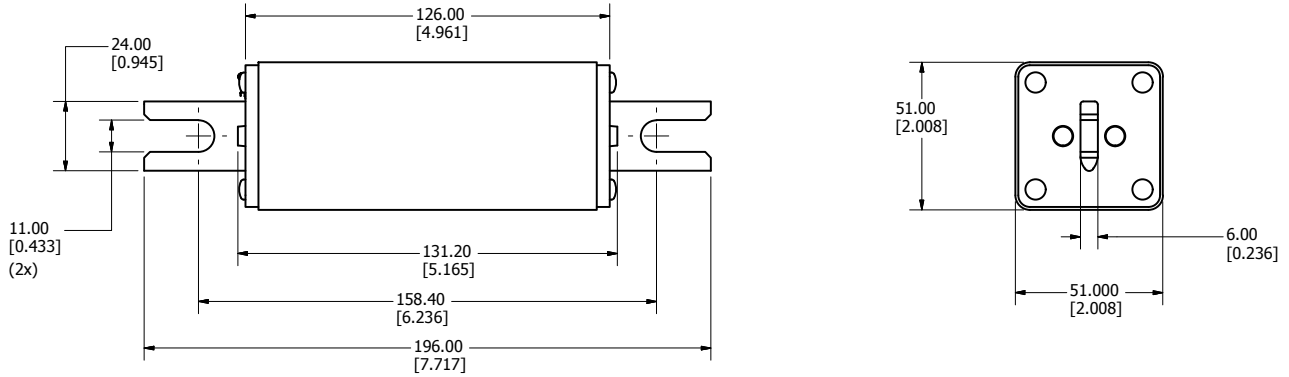

Size: 1XL DL Blade

Recommended Torque: 44 Nm*

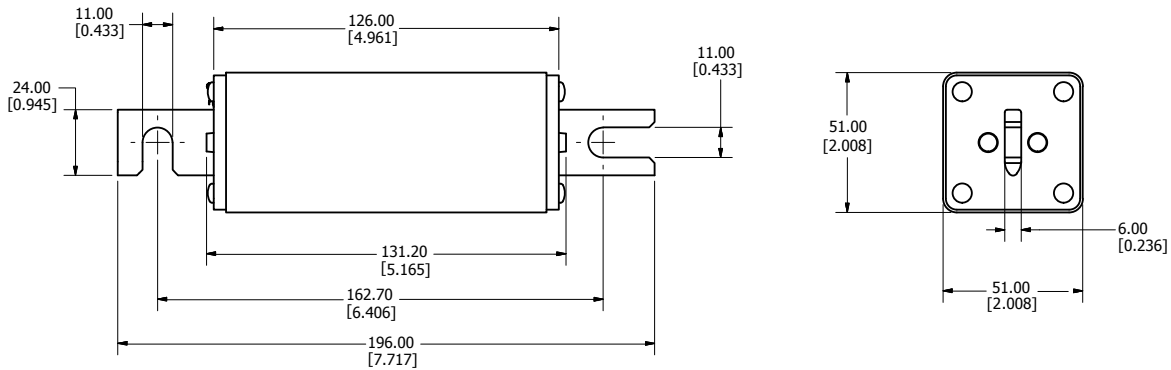

Size: 2 XL DE Blade

Recommended Torque: 77 Nm*

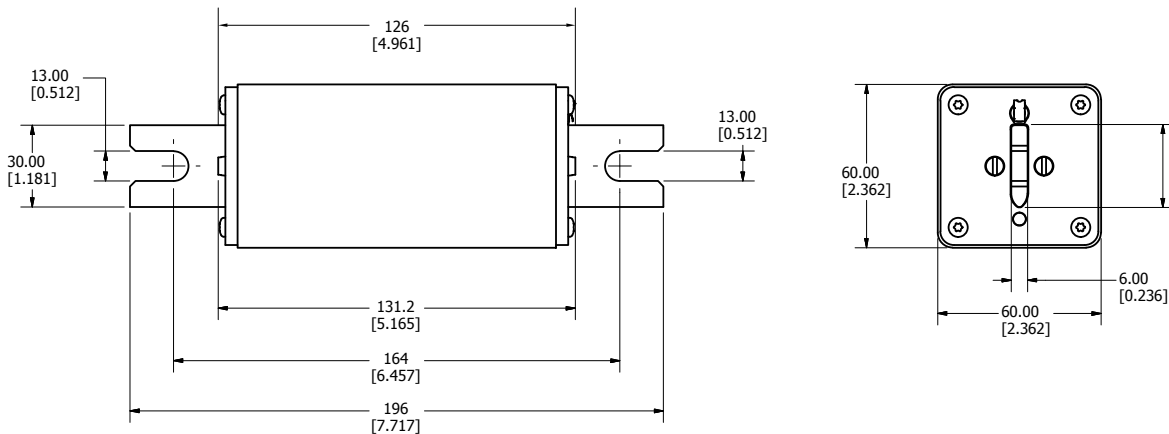

*recommended torque values are for grade 8 steel hardware

Dimensions Millimeters (in)

Size: 2 XL DL Blade

Recommended Torque: 44 Nm*

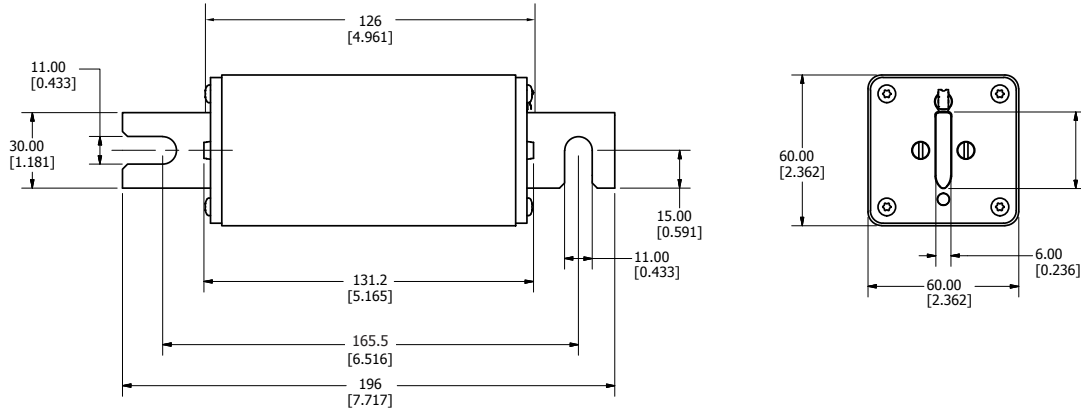

Size: 3 L DE Blade

Recommended Torque: 77 Nm*

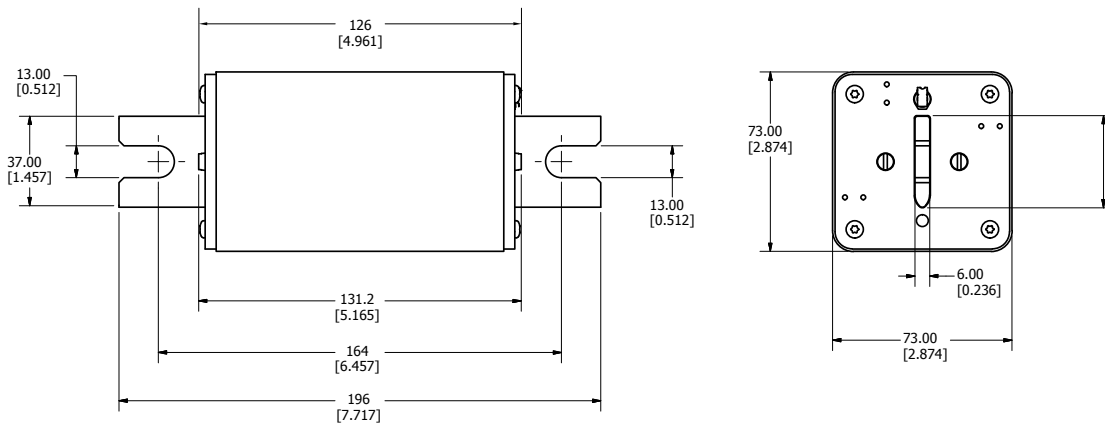

Size: 3 L DL Blade

Recommended Torque: 44 Nm*

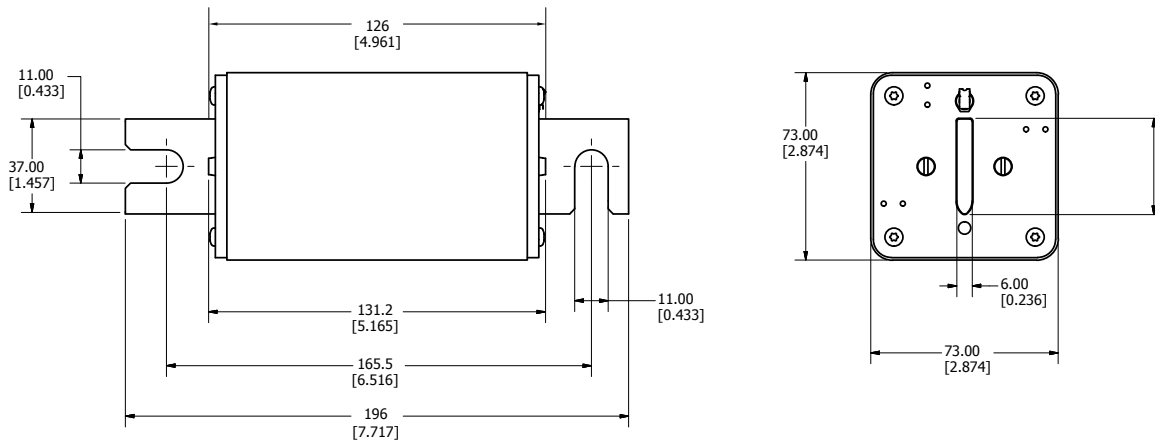

*recommended torque values are for grade 8 steel hardware

Dimensions Millimeters (in)

Size: 1 XL DL Blade w/ Microswitch Tab

Recommended Torque: 44 Nm*

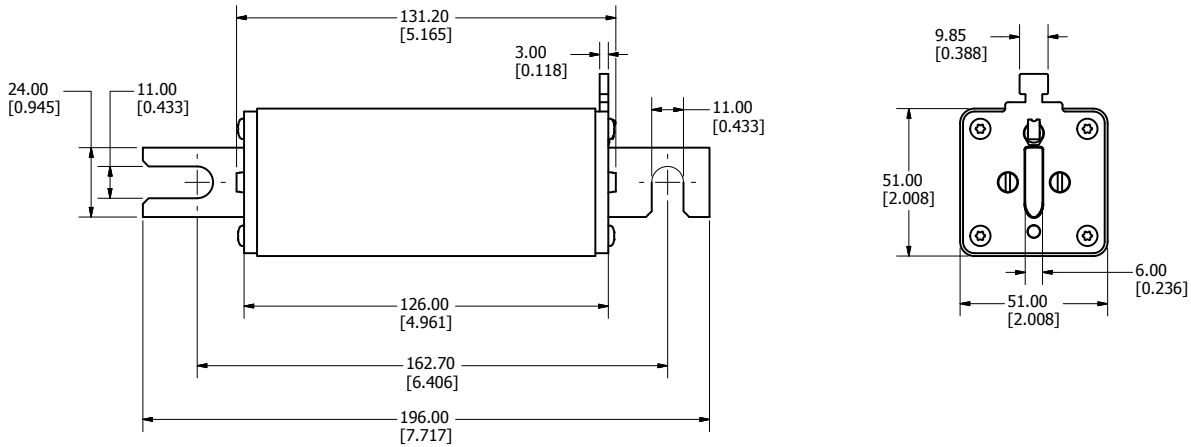

Size: 1 XL DE Blade w/ Microswitch Tab

Recommended Torque: 44 Nm*

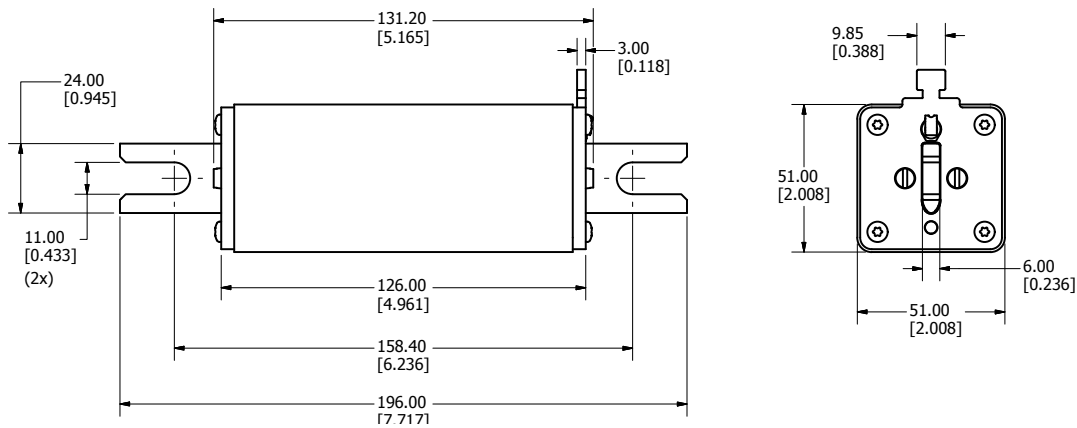

Size: 2 XL DL Blade w/ Microswitch Tab

Recommended Torque: 44 Nm*

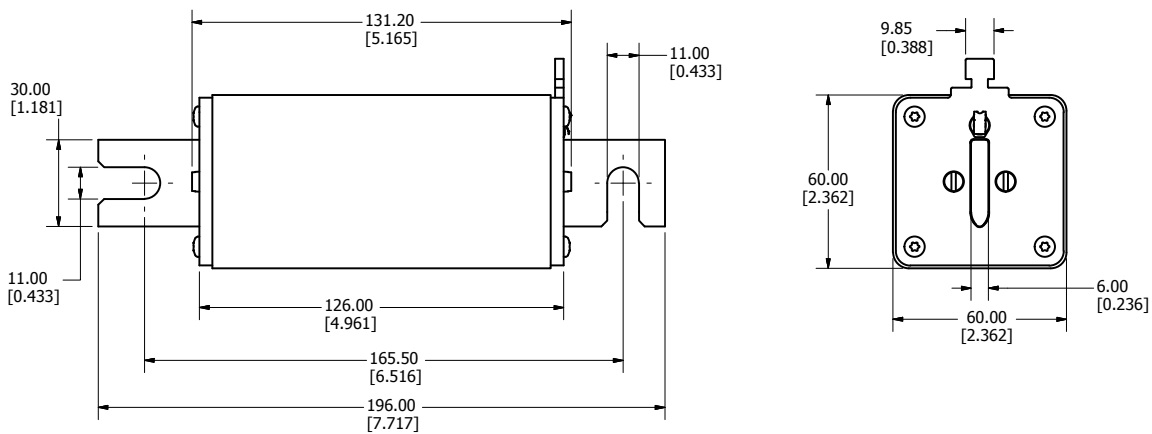

*recommended torque values are for grade 8 steel hardware

Dimensions Millimeters (in)

Size: 2 XL DE Blade w/ Microswitch Tab

Recommended Torque: 77 Nm*

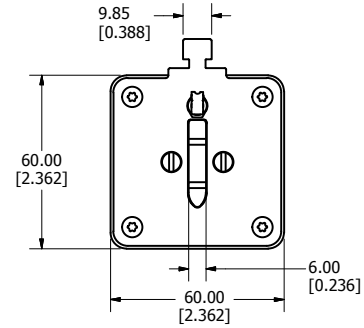
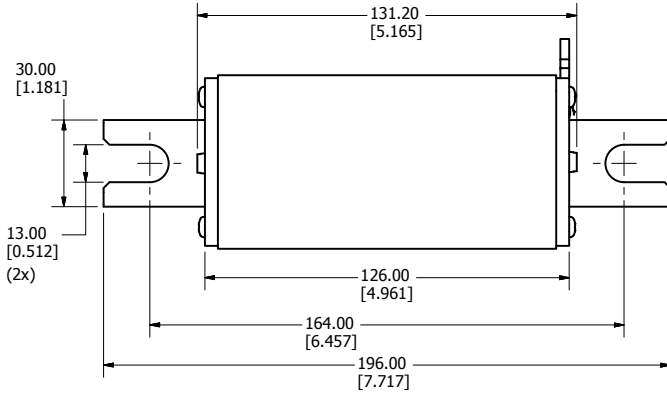

Size: 3 L DL Blade w/ Microswitch Tab

Recommended Torque: 44 Nm*

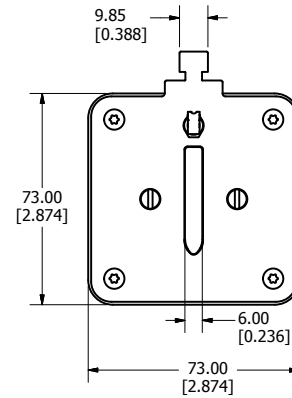
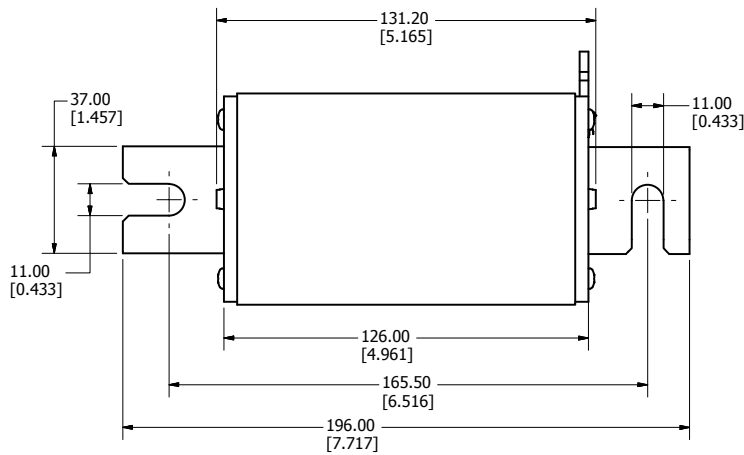

Size: 3 L DE Blade w/ Microswitch Tab

Recommended Torque: 77 Nm*

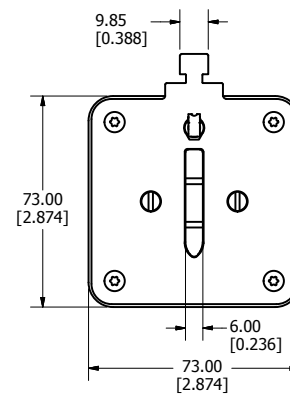
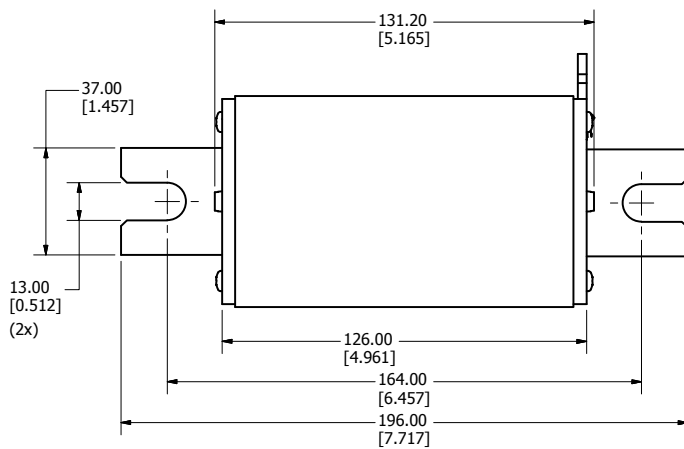

*recommended torque values are for grade 8 steel hardware

POWR-GARD® Fuse Datasheet

SPNH SERIES SOLAR FUSE

Electrical Specifications

AMPERAGE RATING	VOLTAGE RATING	INTERRUPTING RATING	NOM COLD RESISTANCE (mΩ)	MELTING (PRE-ARC) I ² T (A ² s)	TOTAL CLEARING I ² T (A ² s) AT RATED VOLTAGE	WATTS LOSS AT 100% RATED CURRENT (W)	WATTS LOSS AT 70% RATED CURRENT (W)	SIZE
	DC	DC						
50	1500	30 kA	3.95	800	3,500	14	6	1 XL
63	1500	30 kA	2.96	1,500	6,000	14	6.2	
80	1500	30 kA	2.36	5,000	15,000	16	7	
100	1500	30 kA	1.47	10,000	26,000	19	8.3	
125	1500	30 kA	1.07	15,000	37,000	22	9.7	
160	1500	30 kA	0.85	19,000	48,000	30	13.2	
200	1500	30 kA	0.63	22,000	75,000	32.5	13.7	2 XL
200	1500	30 kA	0.66	42,000	75,000	36	15.9	
250	1500	30 kA	0.51	73,000	132,000	44	19.3	
315	1500	50 kA	0.37	65,000	300,000	57	22.2	3 L
350	1500	50 kA	0.33	75,000	350,000	61	23.7	
400	1500	50 kA	0.28	85,000	450,000	67	26.8	

POWR-GARD® Fuse Datasheet

SPNH SERIES SOLAR FUSE

Ordering Information

CONTACT	CASE SIZE	AMPERAGE RATING	AMP CODE	CATALOG NUMBER	PRODUCT MARKING	ORDERING NUMBER	UPC	MICROSWITCH COMPATIBLE CATALOG NUMBER	MICROSWITCH COMPATIBLE PRODUCT MARKING	MICROSWITCH COMPATIBLE ORDERING NUMBER	MICROSWITCH COMPATIBLE UPC	AGENCY APPROVALS
												UL
SOLID BLADE	1XL	50 A	050	SPNH050	SPNH 50A	SPNH050.X	07945804294	SPNH050	SPNH 50A	SPNH050.X	07945804294	•
		63 A	063	SPNH063	SPNH 63A	SPNH063.X	07945804295	SPNH063	SPNH 63A	SPNH063.X	07945804295	•
		80 A	080	SPNH080	SPNH 80A	SPNH080.X	07945804319	SPNH080	SPNH 80A	SPNH080.X	07945804319	•
		100 A	100	SPNH100	SPNH 100A	SPNH100.X	07945804359	SPNH100	SPNH 100A	SPNH100.X	07945804359	•
		125 A	125	SPNH125	SPNH 125A	SPNH125.X	07945804433	SPNH125	SPNH 125A	SPNH125.X	07945804433	•
		160 A	160	SPNH160	SPNH 160A	SPNH160.X	07945804443	SPNH160	SPNH 160A	SPNH160.X	07945804443	•
		200 A	200	SPNH200	SPNH 200A	SPNH200.X	07945804552	SPNH200	SPNH 200A	SPNH200.X	07945804552	•
	2XL	200 A	200	SPNH200-2XL	SPNH 200A-2XL	SPNH200.X2XL	07945819771	SPNH200-2XL	SPNH 200A-2XL	SPNH200.X2XL	07945819771	•
		250 A	250	SPNH250-2XL	SPNH 250A-2XL	SPNH250.X2XL	07945819772	SPNH250-2XL	SPNH 250A-2XL	SPNH250.X2XL	07945819772	•
	3L	315 A	315	SPNH315-3L	SPNH 315A-3L	SPNH315.X3L	07945821115	SPNH315-3L	SPNH 315A-3L	SPNH315.X3L	07945821115	•
		350 A	350	SPNH350-3L	SPNH 350A-3L	SPNH350.X3L	07945821116	SPNH350-3L	SPNH 350A-3L	SPNH350.X3L	07945821116	•
	DL BLADE (S)	1XL	50 A	050	SPNH050-DL	SPNH 50A-DL	SPNH050.XXDL	07945819843	SPNH050-DLMS	SPNH 50A-DLMS	SPNH050.XXDLMS	07945823539
63 A			063	SPNH063-DL	SPNH 63A-DL	SPNH063.XXDL	07945819844	SPNH063-DLMS	SPNH 63A-DLMS	SPNH063.XXDLMS	07945823541	•
80 A			080	SPNH080-DL	SPNH 80A-DL	SPNH080.XXDL	07945819845	SPNH080-DLMS	SPNH 80A-DLMS	SPNH080.XXDLMS	07945823543	•
100 A			100	SPNH100-DL	SPNH 100A-DL	SPNH100.XXDL	07945819846	SPNH0100-DLMS	SPNH 100A-DLMS	SPNH0100.XXDLMS	07945823545	•
125 A			125	SPNH125-DL	SPNH 125A-DL	SPNH125.XXDL	07945819847	SPNH0125-DLMS	SPNH 125A-DLMS	SPNH0125.XXDLMS	07945823547	•
160 A			160	SPNH160-DL	SPNH 160A-DL	SPNH160.XXDL	07945819848	SPNH0160-DLMS	SPNH 160A-DLMS	SPNH0160.XXDLMS	07945823549	•
200 A			200	SPNH200-DL	SPNH 200A-DL	SPNH200.XXDL	07945819849	SPNH0200-DLMS	SPNH 200A-DLMS	SPNH0200.XXDLMS	07945823553	•
2XL		200 A	200	SPNH200-2XLDL	SPNH 200A-2XLDL	SPNH200.X2XLDL	07945819850	SPNH0200-2XLDLMS	SPNH 200A-2XLDLMS	SPNH0200.X2XLDLMS	07945823551	•
		250 A	250	SPNH250-2XLDL	SPNH 250A-2XLDL	SPNH250.X2XLDL	07945819851	SPNH0250-2XLDLMS	SPNH 250A-2XLDLMS	SPNH0250.X2XLDLMS	07945823555	•
3L		315 A	315	SPNH315-3LDL	SPNH 315A-3LDL	SPNH315.X3LDL	07945821118	SPNH0315-3LDLMS	SPNH 315A-3LDLMS	SPNH0315.X3LDLMS	07945823557	•
		350 A	350	SPNH350-3LDL	SPNH 350A-3LDL	SPNH350.X3LDL	07945821119	SPNH0350-3LDLMS	SPNH 350A-3LDLMS	SPNH0350.X3LDLMS	07945823559	•
DE BLADE (U)		1XL	50 A	050	SPNH050-DE	SPNH 50A-DE	SPNH050.XXDE	07945819852	SPNH050-DEMS	SPNH 50A-DEMS	SPNH050.XXDEMS	07945823538
	63 A		063	SPNH063-DE	SPNH 63A-DE	SPNH063.XXDE	07945819853	SPNH063-DEMS	SPNH 63A-DEMS	SPNH063.XXDEMS	07945823540	•
	80 A		080	SPNH080-DE	SPNH 80A-DE	SPNH080.XXDE	07945819854	SPNH080-DEMS	SPNH 80A-DEMS	SPNH080.XXDEMS	07945823542	•
	100 A		100	SPNH100-DE	SPNH 100A-DE	SPNH100.XXDE	07945819855	SPNH0100-DEMS	SPNH 100A-DEMS	SPNH0100.XXDEMS	07945823544	•
	125 A		125	SPNH125-DE	SPNH 125A-DE	SPNH125.XXDE	07945819856	SPNH0125-DEMS	SPNH 125A-DEMS	SPNH0125.XXDEMS	07945823546	•
	160 A		160	SPNH160-DE	SPNH 160A-DE	SPNH160.XXDE	07945819857	SPNH0160-DEMS	SPNH 160A-DEMS	SPNH0160.XXDEMS	07945823548	•
	200 A		200	SPNH200-DE	SPNH 200A-DE	SPNH200.XXDE	07945819858	SPNH0200-DEMS	SPNH 200A-DEMS	SPNH0200.XXDEMS	07945823552	•
	2XL	200 A	200	SPNH200-2XLDE	SPNH 200A-2XLDE	SPNH200.X2XLDE	07945819859	SPNH0200-2XLDEMS	SPNH 200A-2XLDEMS	SPNH0200.X2XLDEMS	07945823550	•
		250 A	250	SPNH250-2XLDE	SPNH 250A-2XLDE	SPNH250.X2XLDE	07945819860	SPNH0250-2XLDEMS	SPNH 250A-2XLDEMS	SPNH0250.X2XLDEMS	07945823554	•
	3L	315 A	315	SPNH315-3LDE	SPNH 315A-3LDE	SPNH315.X3LDE	07945821121	SPNH0315-3LDEMS	SPNH 315A-3LDEMS	SPNH0315.X3LDEMS	07945823556	•
		350 A	350	SPNH350-3LDE	SPNH 350A-3LDE	SPNH350.X3LDE	07945821122	SPNH0350-3LDEMS	SPNH 350A-3LDEMS	SPNH0350.X3LDEMS	07945823558	•
			400 A	400	SPNH400-3LDE	SPNH 400A-3LDE	SPNH400.X3LDE	07945821123	SPNH0400-3LDEMS	SPNH 400A-3LDEMS	SPNH0400.X3LDEMS	07945823560

Temperature Derating Curve (Temperature of Air Immediately Surrounding Fuse)

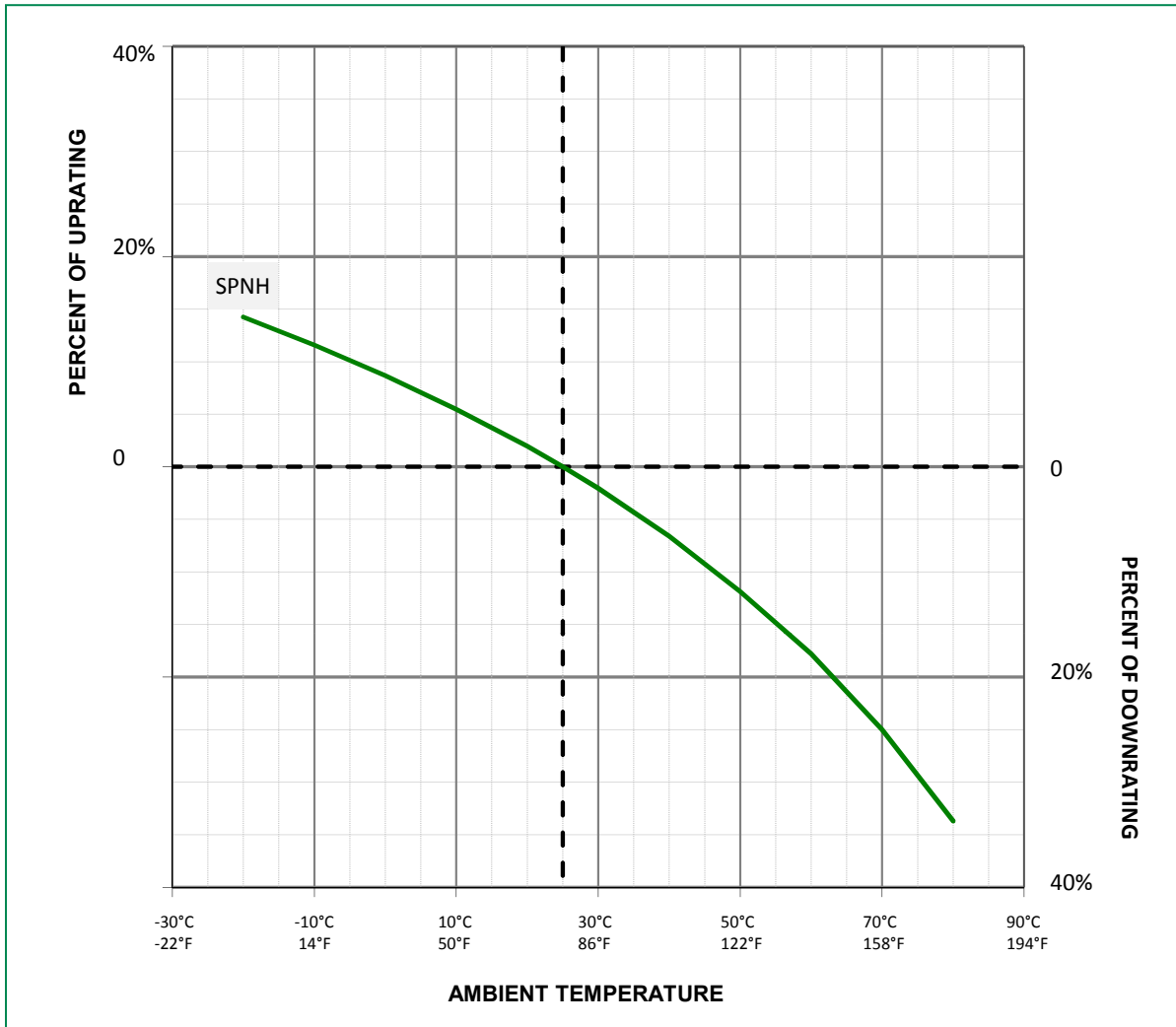

Time Current Curve

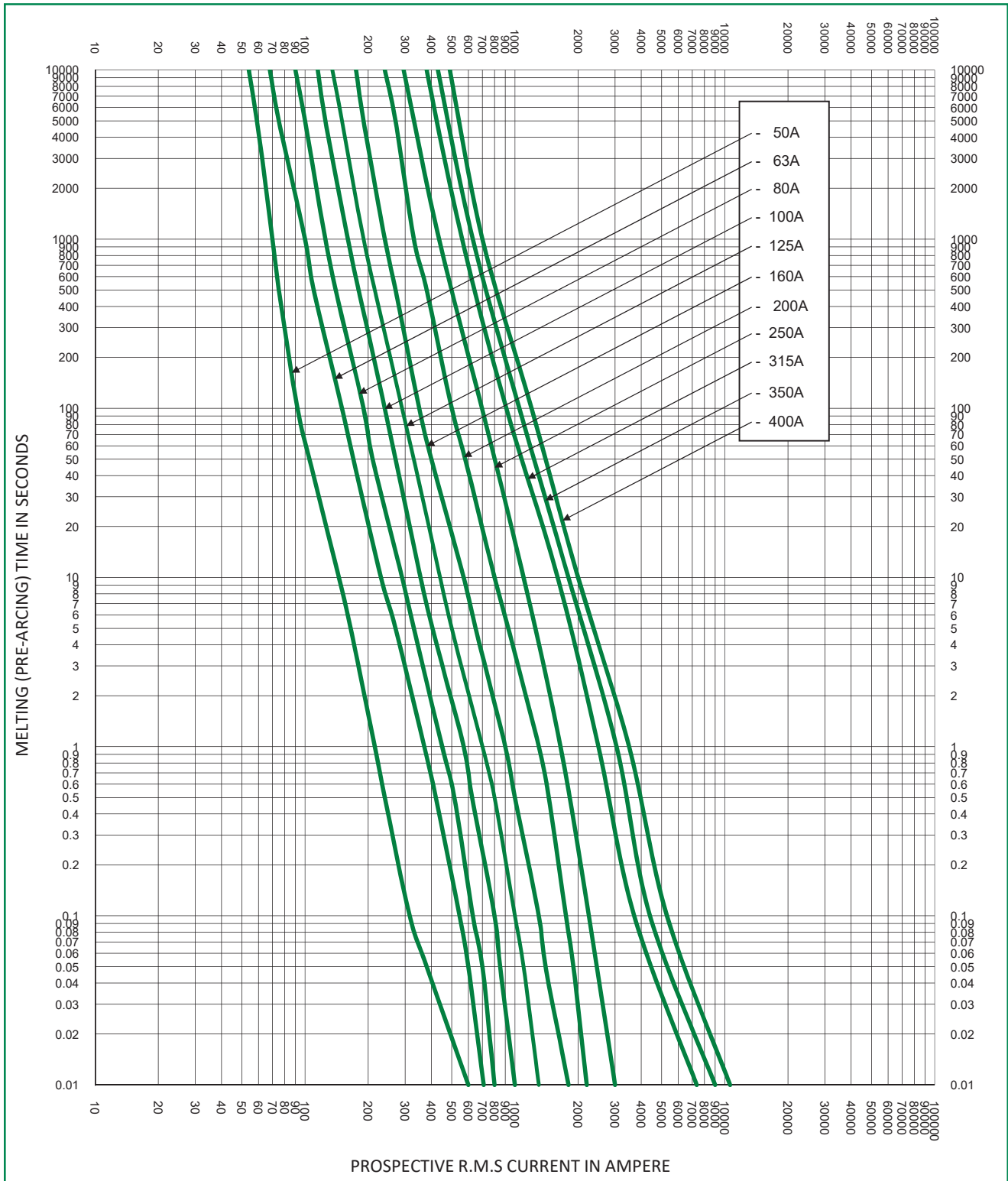

Microswitch

MSSPNH1500X

Dimensions Millimeters (in)

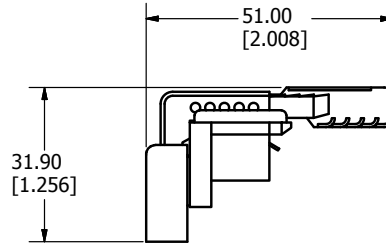
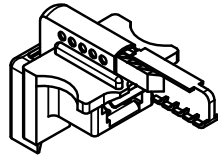

Disclaimer Notice – Information furnished is believed to be accurate and reliable. However, users should independently evaluate the suitability of and test each product selected for their own applications. Littelfuse products are not designed for, and may not be used in, all applications. Read complete Disclaimer Notice at www.littelfuse.com/product-disclaimer.

单击下面可查看定价，库存，交付和生命周期等信息

[>>Littelfuse\(美国力特\)](#)