

**LSIC2SD065C10A 650 V, 10 A SiC Schottky Barrier Diode**



**Description**

This series of silicon carbide (SiC) Schottky diodes has negligible reverse recovery current, high surge capability, and a maximum operating junction temperature of 175 °C. These diodes series are ideal for applications where improvements in efficiency, reliability, and thermal management are desired.

**Features**

- AEC-Q101 qualified
- Positive temperature coefficient for safe operation and ease of paralleling
- 175 °C maximum operating junction temperature
- Excellent surge capability
- Extremely fast, temperature-independent switching behavior
- Dramatically reduced switching losses compared to Si bipolar diodes

**Circuit Diagram TO-252-2L (DPAK)**

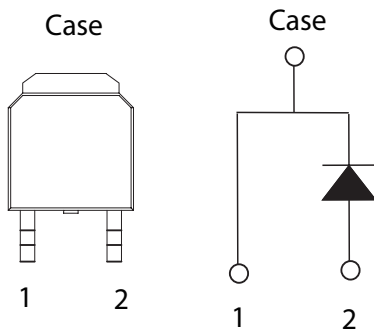

**Applications**

- Boost diodes in PFC or DC/DC stages
- Switch-mode power supplies
- Uninterruptible power supplies
- Solar inverters
- Industrial motor drives
- EV charging stations

**Environmental**

- Littelfuse "RoHS" logo = RoHS conform
- Littelfuse "HF" logo = **HF** Halogen Free
- Littelfuse "Pb-free" logo = Pb-free lead plating

**Maximum Ratings**

Characteristics	Symbol	Conditions	Value	Unit
Repetitive Peak Reverse Voltage	$V_{RRM}$	-	650	V
DC Blocking Voltage	$V_R$	$T_J = 25\text{ °C}$	650	V
Continuous Forward Current	$I_F$	$T_C = 25\text{ °C}$	27	A
		$T_C = 135\text{ °C}$	12.5	
		$T_C = 147\text{ °C}$	10	
Non-Repetitive Forward Surge Current	$I_{FSM}$	$T_C = 25\text{ °C}, T_P = 10\text{ ms}, \text{Half sine pulse}$	48	A
Power Dissipation	$P_{Tot}$	$T_C = 25\text{ °C}$	100	W
		$T_C = 110\text{ °C}$	43	
Operating Junction Temperature	$T_J$	-	-55 to 175	°C
Storage Temperature	$T_{STG}$	-	-55 to 150	°C
Soldering Temperature (reflow MSL1)	$T_{sold}$	-	260	°C

**Electrical Characteristics**

Characteristics	Symbol	Conditions	Value			Unit
			Min.	Typ.	Max.	
Forward Voltage	$V_F$	$I_F = 10 \text{ A}, T_J = 25 \text{ }^\circ\text{C}$	-	1.5	1.8	V
		$I_F = 10 \text{ A}, T_J = 175 \text{ }^\circ\text{C}$	-	1.85	-	
Reverse Current	$I_R$	$V_R = 650 \text{ V}, T_J = 25 \text{ }^\circ\text{C}$	-	<1	50	$\mu\text{A}$
		$V_R = 650 \text{ V}, T_J = 175 \text{ }^\circ\text{C}$	-	25	-	
Total Capacitance	C	$V_R = 1 \text{ V}, f = 1 \text{ MHz}$	-	470	-	pF
		$V_R = 200 \text{ V}, f = 1 \text{ MHz}$	-	60	-	
		$V_R = 400 \text{ V}, f = 1 \text{ MHz}$	-	43	-	
Total Capacitive Charge	$Q_C$	$V_R = 400 \text{ V}, Q_C = \int_0^{V_R} C(V)dV$	-	30	-	nC

**Thermal Characteristics**

Characteristics	Symbol	Value	Unit
Thermal Resistance	$R_{\theta JC}$	1.5	$^\circ\text{C/W}$

**Figure 1: Typical Forward Characteristics**

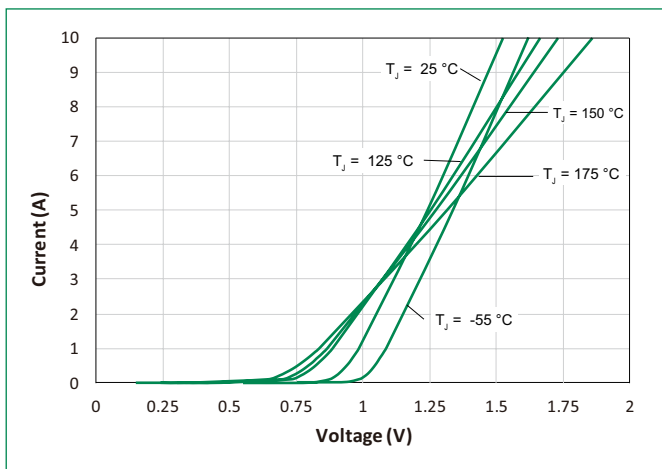

**Figure 2: Typical Reverse Characteristics**

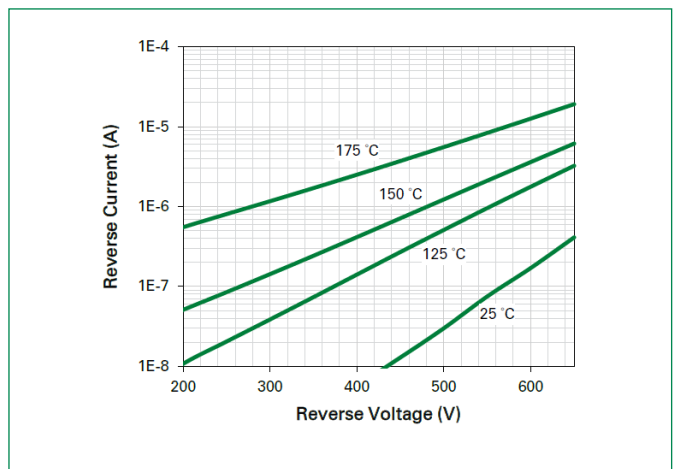

**Figure 3: Power Derating**

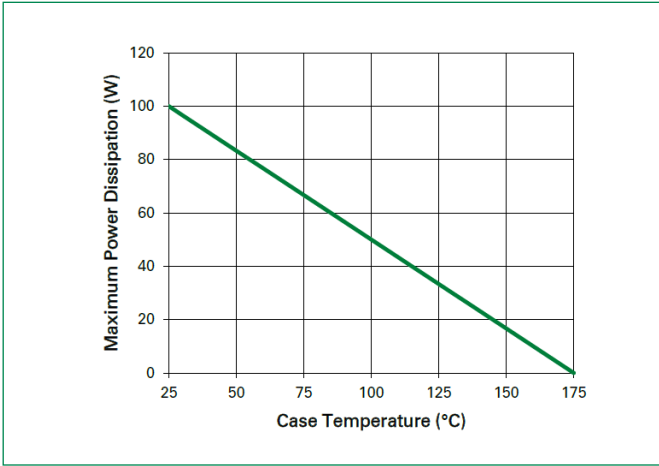

**Figure 4: Current Derating**

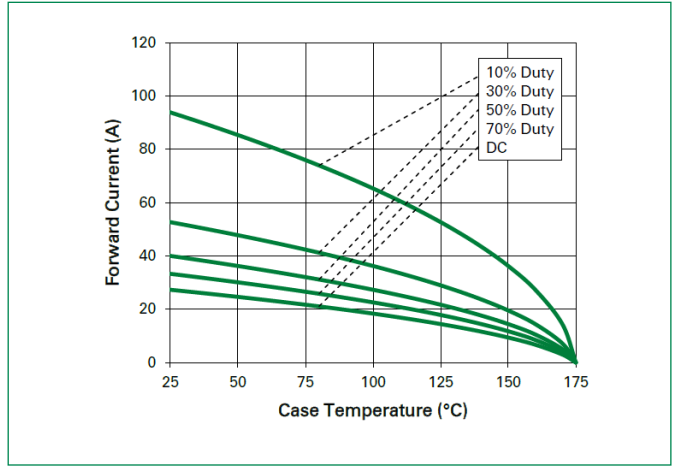

**Figure 5: Capacitance vs. Reverse Voltage**

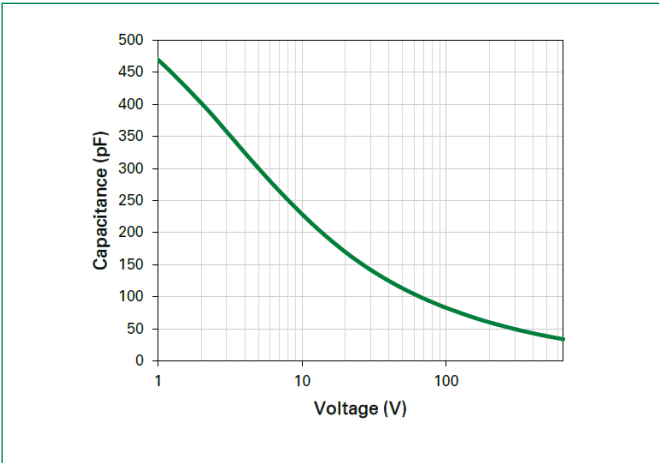

**Figure 6: Capacitive Charge vs. Reverse Voltage**

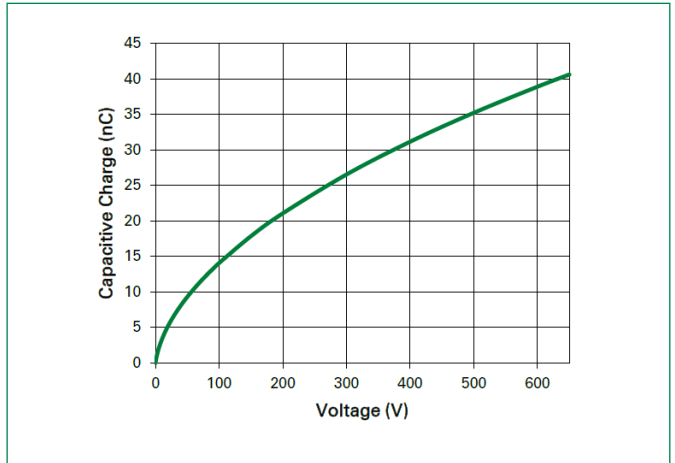

**Figure 7: Stored Energy vs. Reverse Voltage**

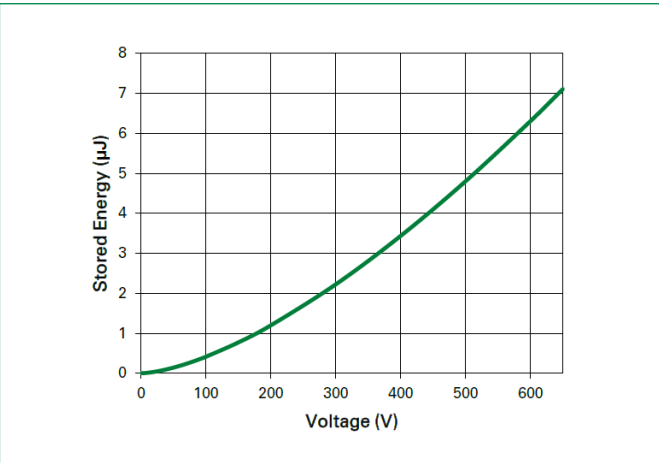

**Figure 8: Transient Thermal Impedance**

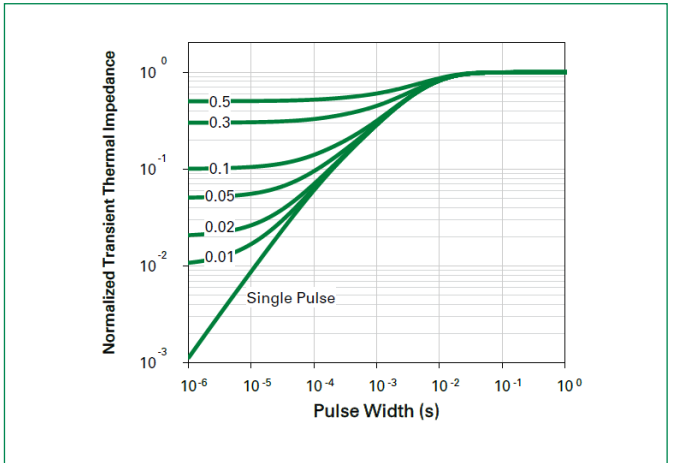

### Dimensions TO-252-2L (DPAK)

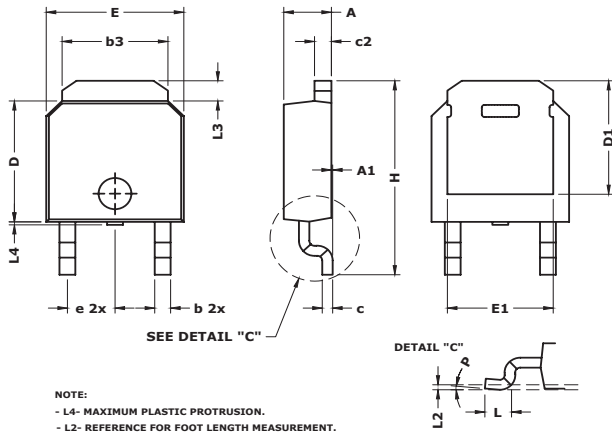

NOTE:  
 - L4- MAXIMUM PLASTIC PROTRUSION.  
 - L2- REFERENCE FOR FOOT LENGTH MEASUREMENT.

#### Recommended Solder Pattern Layout

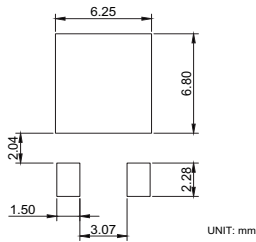

Symbol	Inches			Millimeters		
	Min	Nom	Max	Min	Nom	Max
A	0.085	0.090	0.095	2.16	2.29	2.41
A1	0	0.003	0.005	0	0.08	0.13
b	0.025	0.030	0.035	0.64	0.76	0.89
b3	0.195	0.200	0.215	4.95	5.08	5.46
c	0.018	0.020	0.024	0.46	0.51	0.61
C2	0.018	0.032	0.035	0.46	0.81	0.89
D	0.235	0.240	0.245	5.97	6.10	6.22
D1	0.205	-	-	5.21	-	-
E	0.250	0.260	0.265	6.35	6.60	6.73
E1	0.170	-	-	4.32	-	-
e	0.090 BSC			2.29 BSC		
H	0.370	0.387	0.410	9.40	9.83	10.41
L	0.040	0.045	0.050	1.02	1.14	1.27
L2	0.010 BSC			0.25 BSC		
L3	0.035	-	0.050	0.89	-	1.27
L4	0	-	0.006	0	-	0.15
P	0°	-	8°	0°	-	8°

### Part Numbering and Marking System

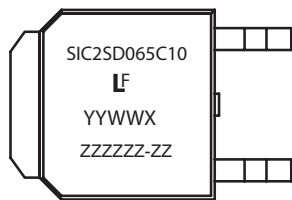

SIC = SiC Diode  
 2 = Gen2  
 SD = Schottky Diode  
 065 = Voltage Rating (650 V)  
 C = TO-252-2L (DPAK)  
 10 = Current Rating (10 A)  
 YY = Year  
 WW = Week  
 X = Special code  
 ZZZZZZ-ZZ = Lot Number

### Packing Options

Part Number	Marking	Packing Mode	M.O.Q
LSIC2SD065C10A	SIC2SD065C10	Tape and Reel	2500

### Carrier Tape & Reel Specification TO-252-2L (DPAK)

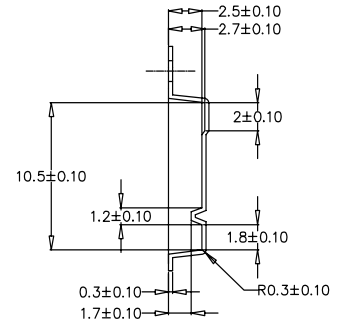
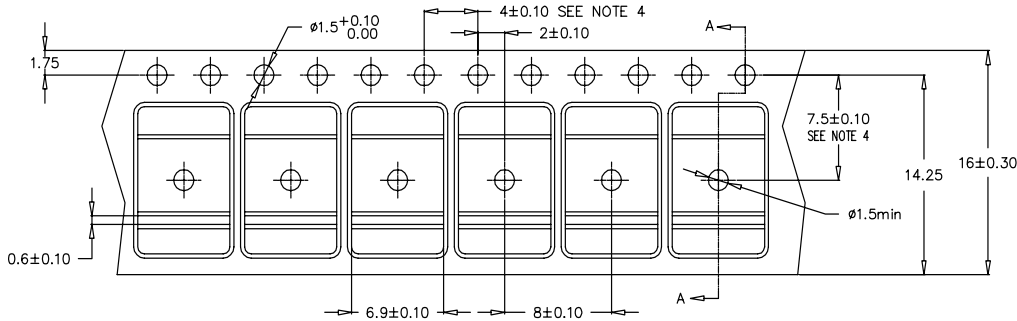

1. Material: Black Conductive Polyesterene
2. 10 sprocket hole pitch cumulative tolerance  $\pm 0.20$
3. Camber not to exceed 1 mm in 100 mm.
4. Pocket position relative to sprocket hole measured as true position of pocket, not pocket hole.
5. Device orientation: TRL (leads perpendicular to the sprocket)
6. General tolerance is  $\pm 0.10$  mm unless otherwise specified.

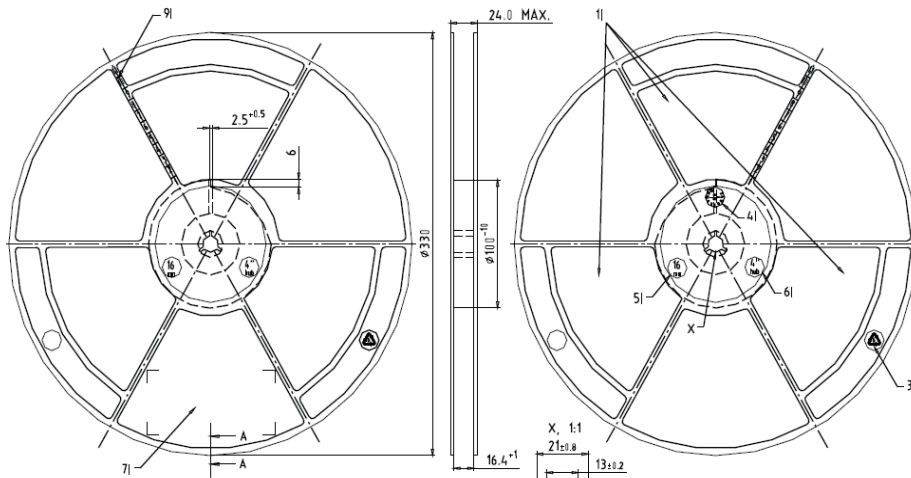

- NOTES
- 1) WINDOW CLEARANCE ON BOTH SIDE DISK.
  - 2) SURFACE RESISTANCE  $\geq 10^9$  OHM AND  $< 1 \times 10^{10}$  OHM. REFER TO IEC 61340-5-1.
  - 3) RECYCLE LOGO WITH MATERIAL CODE "6" IN CIRCLE, ONE OR BOTH SIDE DISK.
  - 4) DATE CODE IN CIRCLE ON ONE SIDE OF DISK.
  - 5) TAPE WIDTH "16 mm" IN CIRCLE, TEXT HEIGHT 6 mm, ON BOTH SIDE DISK.
  - 6) HUB SIZE INDICATION ON BOTH SIDE DISK.
  - 7) AREA OF LABEL, MIN 110 x 55.
  - 8) NUMBER OF GROOVES ACCORDING TO PRODUCER, EITHER 3 OR 6.
  - 9) DEPRESSION LINEAR SCALE IS PREFERRED, 10 mm INTERVAL, HEIGHT OF LETTERING 3 mm.
- NON CRITICAL DIMENSIONS ACCORDING TO PRODUCER.

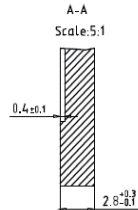

**Disclaimer Notice - Littelfuse products are not designed for, and shall not be used for, any purpose (including, without limitation, automotive, military, aerospace, medical, life-saving, life-sustaining or nuclear facility applications, Components intended for surgical implant into the body, or any other application in which the failure or lack of desired operation of the product may result in personal injury, death, or property damage) other than those expressly set forth in applicable Littelfuse product documentation. Warranties granted by Littelfuse shall be deemed void for products used for any purpose not expressly set forth in applicable Littelfuse documentation. Littelfuse shall not be liable for any claims or damages arising out of products used in applications not expressly intended by Littelfuse as set forth in applicable Littelfuse documentation. The sale and use of Littelfuse products is subject to Littelfuse Terms and Conditions of Sale, unless otherwise agreed by Littelfuse. Information furnished is believed to be accurate and reliable. However, users should independently evaluate the suitability of and test each product selected for their own applications. Littelfuse products are not designed for, and may not be used in, all applications. Read complete Disclaimer Notice at [www.littelfuse.com/disclaimer-electronics](http://www.littelfuse.com/disclaimer-electronics).**

单击下面可查看定价，库存，交付和生命周期等信息

[>>Littelfuse\(美国力特\)](#)