



Description

The A0609CA2LRP is a LCAS protector that does not require an external voltage reference. It specifically provides protection for a balanced ringing system with a ringing voltage range of +54 volts and -78 volts.

This three pin modified DO-214AA solution provides a smaller footprint and lower component count than the typical dual polarity programmable SLIC protector. This new overvoltage protector is applicable for WLL (Wireless local loops), VoIP (Voice over IP) and regenerated POTS (Plain Old Telephone Systems) applications.

Agency Approvals

Agency	Agency File Number
	E133083

Pinout Designation

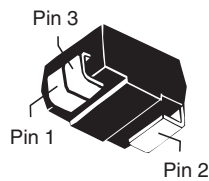

Features and Benefits

- Robust surge rating
- Switching speeds of nanoseconds
- Eliminates the need for large, bulky capacitors and blocking diodes required by traditional programmable solutions
- Solid-State transient protection
- Modified DO-214AA
- Fixed voltage asymmetrical design
- Lower component count solution
- Halogen free and RoHS compliant
- 2nd level interconnect is Pb-free per IPC/ JEDEC J-STD-609A.01

Schematic Symbol

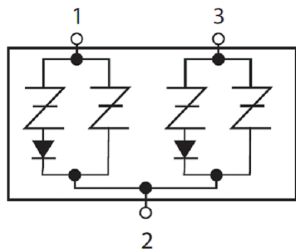

Applicable Global Standards

- ITU K.20/21 Enhanced Level* Edition*
 - ITU K.20/21 Basic Level
 - GR 1089 Inter-building*
 - GR 1089 Intra-building
 - IEC 61000-4-5 2nd
 - YD/T 1082
 - YD/T 993
 - YD/T 950
- * Line impedance required to pass operationally

Electrical Characteristics

Part Number	Marking	V_{DRM}	V_S	V_{DRM}	V_S	V_T	I_{DRM}	I_H	I_S	I_T	Capacitance
		@ $I_{DRM}=5\mu A$	@ $100V/\mu s$	@ $I_{DRM}=5\mu A$	@ $100V/\mu s$	@ $I_T=2.2 A$					@ 1MHz, 3V bias
		V min	V max	V min	V max	V max	μA	mA min	mA max	A max	pF typ
A0609CA2LRP	A0609A	54*	95*	78**	120**	4	5	120	800	2.2	32

Notes:
- Absolute maximum ratings measured at $T_A = 25^\circ C$ (unless otherwise noted).
- Component is asymmetrical

* Positive voltage threshold
** Negative voltage threshold

Surge Ratings

Series	I_{PP}			I_{TSM} 50/60 Hz	di/dt
	8/20 ¹ 1.2/50 ²	10/1000 ¹ 10/1000 ²	5/310 ¹ 10/700 ²		
	A min	A min	A min		
A	150	50	100	12	500

Notes:

- 1 Current waveform in μs
 - 2 Voltage waveform in μs
- Peak pulse current rating (I_{pp}) is repetitive and guaranteed for the life of the product.
 - I_{PP} ratings applicable over temperature range of $-40^{\circ}C$ to $+85^{\circ}C$
 - The component must initially be in thermal equilibrium with $-40^{\circ}C \leq T_J \leq +150^{\circ}C$

Thermal Considerations

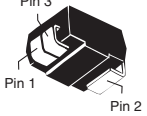
Package	Symbol	Parameter	Value	Unit
Modified DO-214AA 	T_J	Operating Junction Temperature Range	-40 to +150	$^{\circ}C$
	T_S	Storage Temperature Range	-65 to +150	$^{\circ}C$
	$R_{\theta JA}$	Thermal Resistance: Junction to Ambient	85	$^{\circ}C/W$

V-I Characteristics

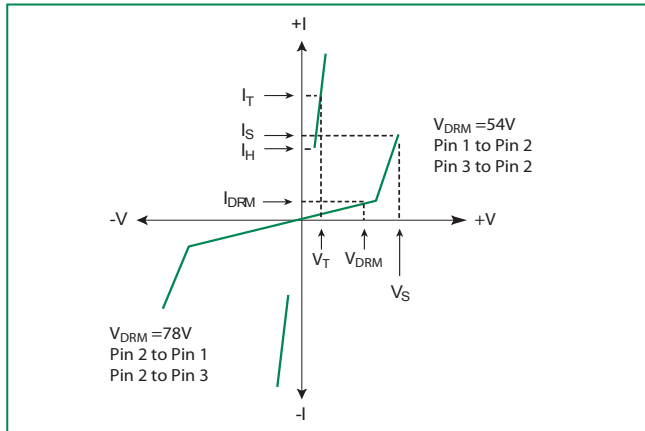

$t_r \times t_d$ Pulse Waveform

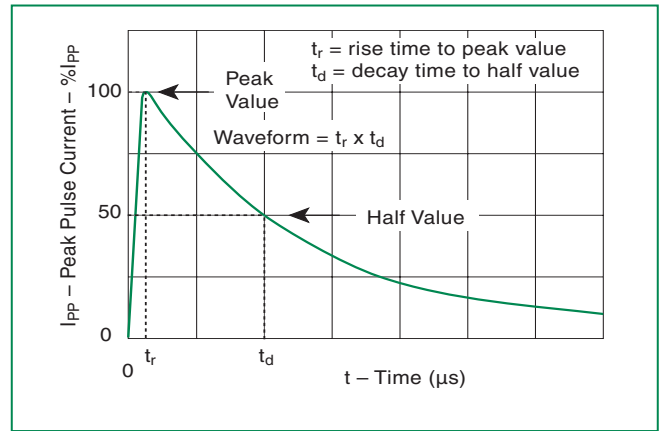

Normalized V_S Change vs. Junction Temperature

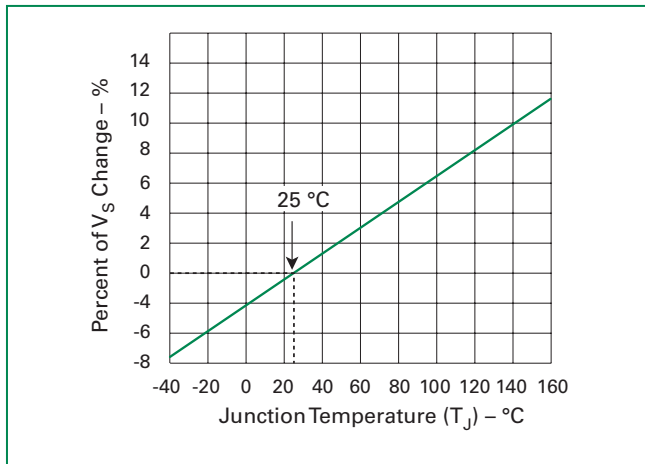

Normalized DC Holding Current vs. Case Temperature

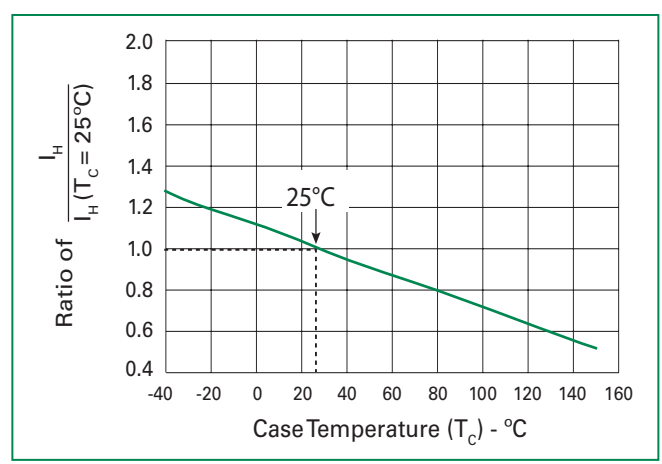

Soldering Parameters

Reflow Condition		Pb-Free assembly (see Fig. 1)
Pre Heat	-Temperature Min ($T_{s(min)}$)	+150°C
	-Temperature Max ($T_{s(max)}$)	+200°C
	-Time (Min to Max) (t_s)	60-180 secs.
Average ramp up rate (Liquidus Temp (T_L) to peak)		3°C/sec. Max.
$T_{s(max)}$ to T_L - Ramp-up Rate		3°C/sec. Max.
Reflow	-Temperature (T_L) (Liquidus)	+217°C
	-Temperature (t_L)	60-150 secs.
Peak Temp (T_p)		+260(+0/-5)°C
Time within 5°C of actual Peak Temp (t_p)		30 secs. Max.
Ramp-down Rate		6°C/sec. Max.
Time 25°C to Peak Temp (T_p)		8 min. Max.
Do not exceed		+260°C

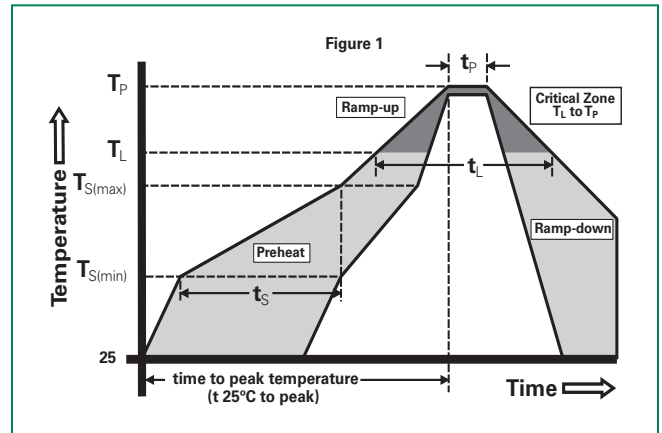

Physical Specifications

Lead Material	Copper Alloy
Terminal Finish	100% Matte-Tin Plated
Body Material	UL Recognized epoxy meeting flammability classification V-0

Environmental Specifications

High Temp Voltage Blocking	80% Rated V_{DRM} (V_{AC} Peak) +125°C or +150°C, 504 or 1008 hrs. MIL-STD-750 (Method 1040) JEDEC, JESD22-A-101
Temp Cycling	-65°C to +150°C, 15 min. dwell, 10 up to 100 cycles. MIL-STD-750 (Method 1051) EIA/JEDEC, JESD22-A104
Biased Temp & Humidity	52 V_{DC} (+85°C) 85%RH, 504 up to 1008 hrs. EIA/JEDEC, JESD22-A-101
High Temp Storage	+150°C 1008 hrs. MIL-STD-750 (Method 1031) JEDEC, JESD22-A-101
Low Temp Storage	-65°C, 1008 hrs.
Thermal Shock	0°C to +100°C, 5 min. dwell, 10 sec. transfer, 10 cycles. MIL-STD-750 (Method 1056) JEDEC, JESD22-A-106
Autoclave (Pressure Cooker Test)	+121°C, 100%RH, 2atm, 24 up to 168 hrs. EIA/JEDEC, JESD22-A-102
Resistance to Solder Heat	+260°C, 30 secs. MIL-STD-750 (Method 2031)
Moisture Sensitivity Level	85%RH, +85°C, 168 hrs., 3 reflow cycles (+260°C peak). JEDEC-J-STD-020, Level 1

Part Numbering

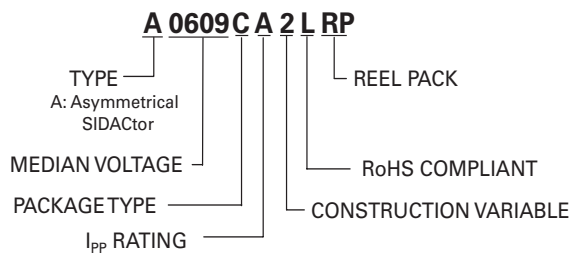

Part Marking

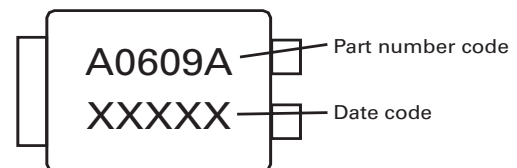

Dimensions — Modified DO-214AA

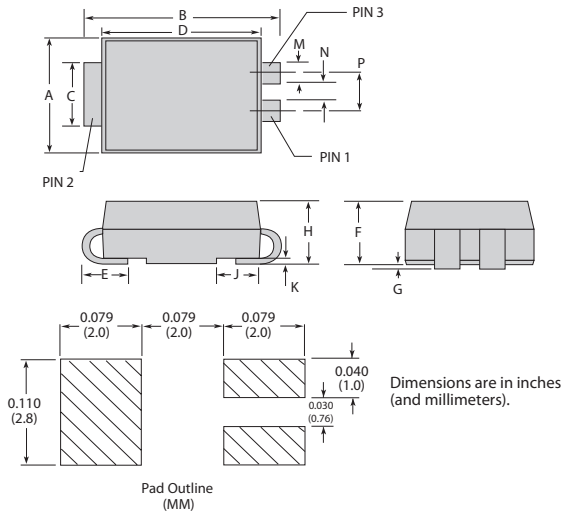

Dimensions	Inches		Millimeters	
	Min	Max	Min	Max
A	0.130	0.156	3.30	3.95
B	0.201	0.220	5.10	5.60
C	0.077	0.087	1.95	2.20
D	0.159	0.181	4.05	4.60
E	0.030	0.063	0.75	1.60
F	0.075	0.096	1.90	2.45
G	0.002	0.008	0.05	0.20
H	0.077	0.104	1.95	2.65
K	0.006	0.016	0.15	0.41
M	0.022	0.028	0.56	0.71
N	0.027	0.033	0.69	0.84
P	0.052	0.058	1.32	1.47

Packing Options

Package Type	Description	Quantity	Added Suffix	Industry Standard
C	Modified DO-214AA 3-leaded Tape and Reel Pack	2500	RP	EIA-481-D

Tape and Reel Specification — Modified DO-214AA

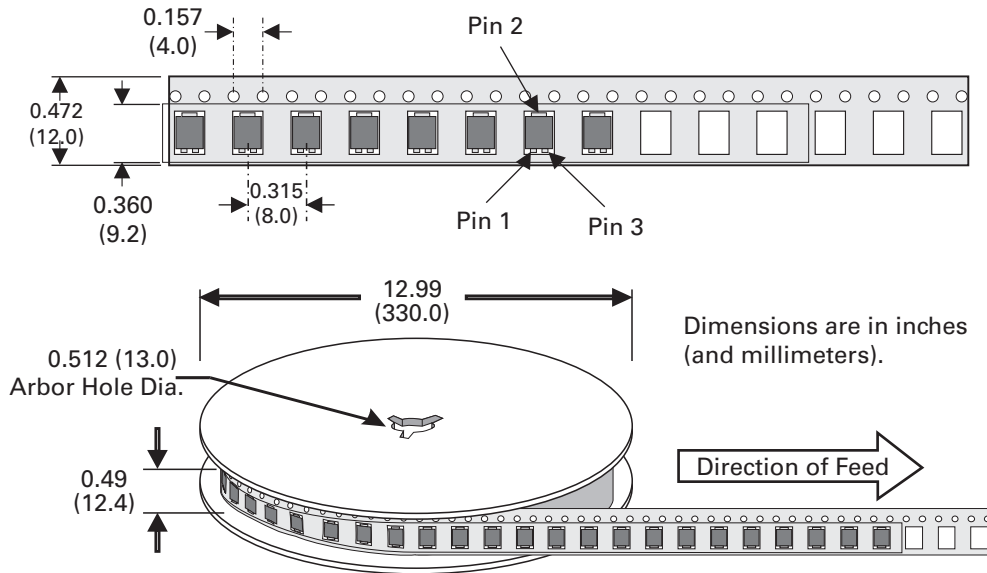

单击下面可查看定价，库存，交付和生命周期等信息

[>>Littelfuse\(美国力特\)](#)