

SP3420, 0.32pF, 6A Diode Array

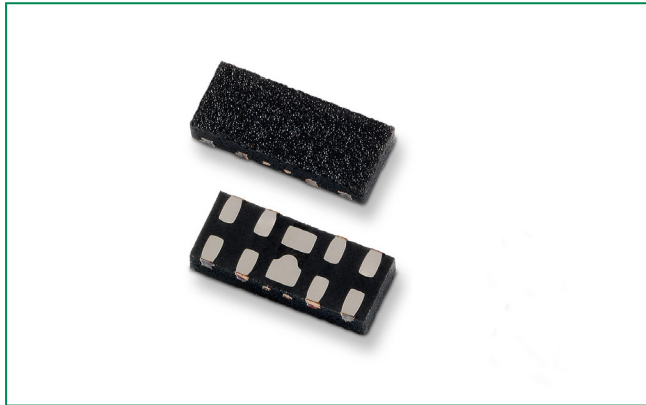

Description

The SP3420 includes four channel ultra low capacitance and high-level ESD protection diodes to protect high-speed data rate such as USB 3.1, DisplayPort, Thunderbolt, and e-SATA. The typical capacitance of 0.32pF helps ensure signal integrity and this robust device can safely absorb repetitive ESD strikes at the maximum level specified in the IEC 61000-4-2 international standard (Level 4, ±8kV contact discharge) without performance degradation safely dissipate 6A of 8/20µs surge current (IEC 61000-4-5 2nd edition).

Pinout

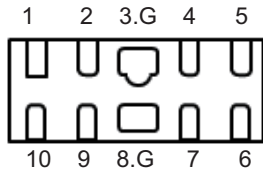

Features

- ESD, IEC 61000-4-2, ±12kV contact, ±15kV air
- EFT, IEC 61000-4-4, 40A (5/50ns)
- Lightning, IEC 61000-4-5 2nd edition, 6A (t_p=8/20µs)
- Low capacitance of 0.32pF@1.5V (TYP)
- Low leakage current of 0.02µA (TYP) at 3.3V
- Low operating and clamping voltage
- AEC-Q101 qualified
- Halogen free, Lead free and RoHS compliant
- Moisture Sensitivity Level (MSL -1)

Functional Block Diagram

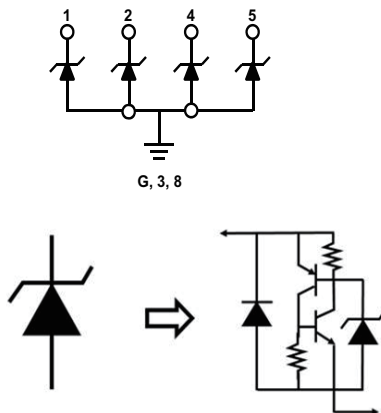

Applications

- Ultra-high speed data lines
- USB 3.1, 3.0, 2.0
- DisplayPort(TM)
- Thunderbolt (Light Peak)
- V-by-One®
- LVDS interfaces
- Consumer, mobile and portable electronics
- Tablet PC and external storage with high speed interfaces

Life Support Note:
Not Intended for Use in Life Support or Life Saving Applications
The products shown herein are not designed for use in life sustaining or life saving applications unless otherwise expressly indicated.

Absolute Maximum Ratings

Symbol	Parameter	Value	Units
I_{PP}	Peak Current ($t_p=8/20\mu s$)	6	A
T_{OP}	Operating Temperature	-40 to 125	°C
T_{STOR}	Storage Temperature	-55 to 150	°C

Notes:

CAUTION: Stresses above those listed in "Absolute Maximum Ratings" may cause permanent damage to the component. This is a stress only rating and operation of the component at these or any other conditions above those indicated in the operational sections of this specification is not implied.

Electrical Characteristics ($T_{OP}=25^\circ C$)

Parameter	Symbol	Test Conditions	Min	Typ	Max	Units
Reverse Standoff Voltage	V_{RWM}	$I_R = 1\mu A$			3.3	V
Breakdown Voltage	V_{BR}	$I_R = 1mA$	6.5	8.5		V
Reverse Leakage Current	I_{LEAK}	$V_R=3.3V$		0.02	0.1	μA
Holding Voltage	V_{HOLD}	I/O to GND		1.7		V
Clamp Voltage ¹	V_C	$I_{PP}=1A, t_p=8/20\mu s$		2.7	3.5	V
		$I_{PP}=6A, t_p=8/20\mu s$		4	6	V
Dynamic Resistance ²	R_{DYN}	TLP, $t_p=100ns$		0.3		Ω
ESD Withstand Voltage ^{1,3}	V_{ESD}	IEC 61000-4-2 (Contact Discharge)	± 12			kV
		IEC 61000-4-2 (Air Discharge)	± 15			kV
Diode Capacitance ¹	$C_{I/O-GND}$	Reverse Bias=1.5V, $f=1MHz$		0.32	0.35	pF

Notes:

1Parameter is guaranteed by design and/or component characterization.

2 Transmission Line Pulse (TLP) test setting : Std. TDR(50 Ω), $t_p=100ns$, $t_r=0.2ns$ ITLP and VTLP averaging window: start $t_1=70ns$ to end $t_2=90ns$

3 Device stressed with ten non-repetitive ESD pulses.

8/20 μs Pulse Waveform

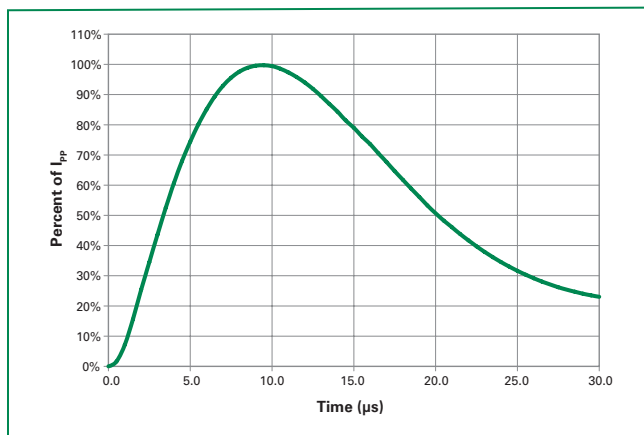

Capacitance vs. Reverse Bias

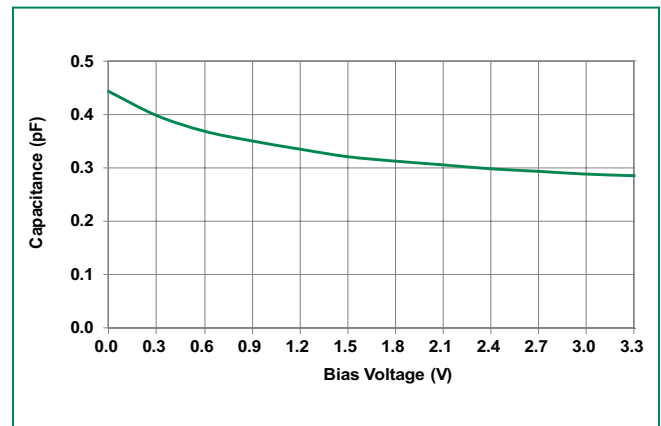

Positive Transmission Line Pulsing (TLP) Plot

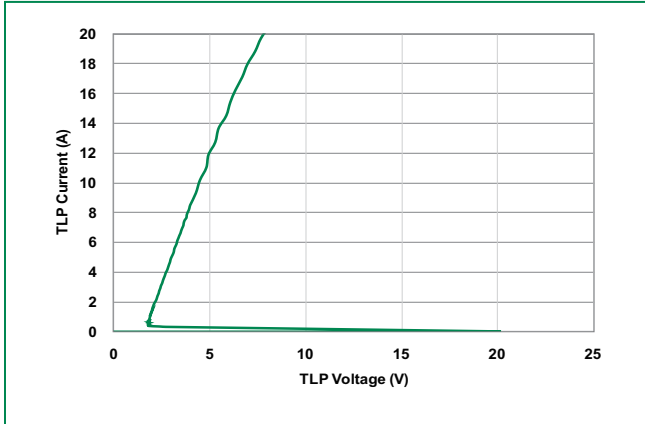

Negative Transmission Line Pulsing (TLP) Plot

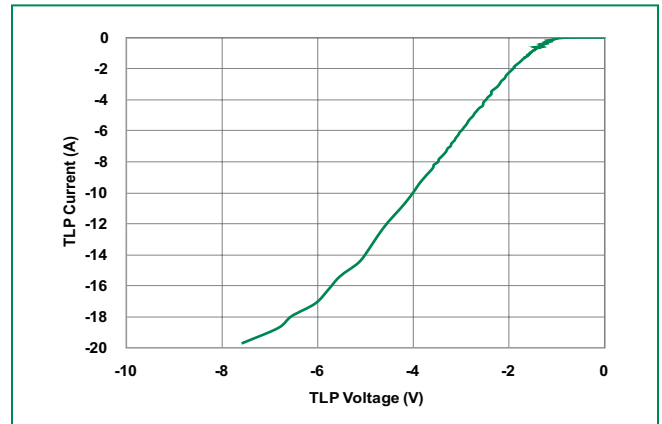

Clamping Voltage vs. Peak Pulse Current

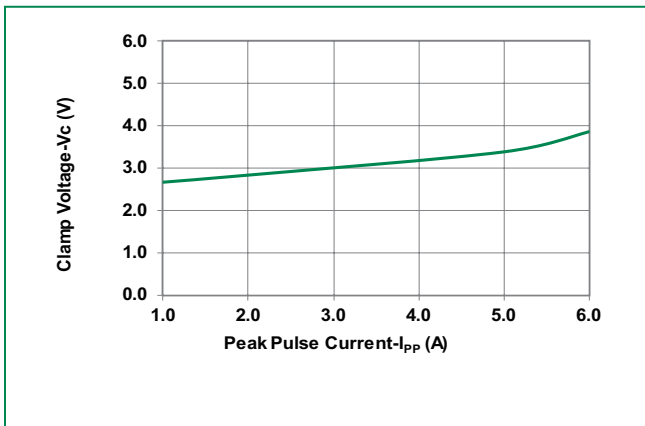

IEC 61000-4-2 +8 kV Contact ESD Clamping Voltage

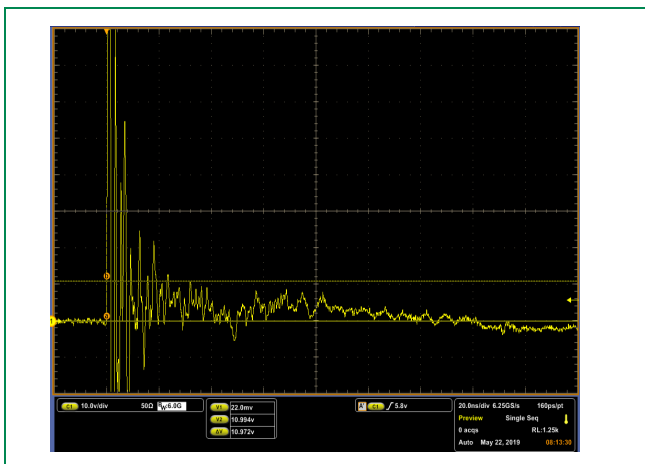

IEC 61000-4-2 -8 kV Contact ESD Clamping Voltage

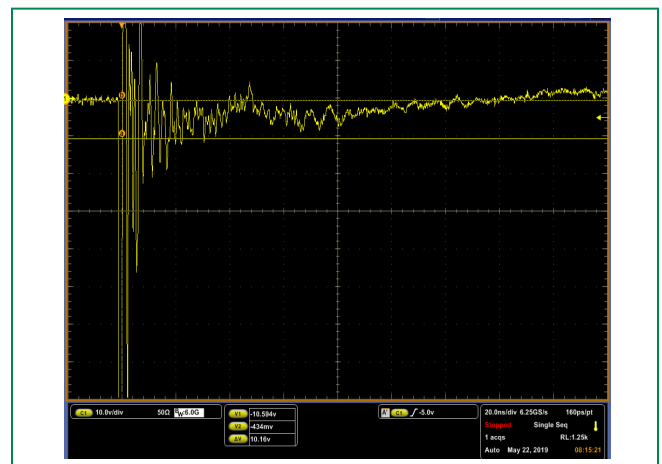

Soldering Parameters

Reflow Condition		Pb – Free assembly
Pre Heat	- Temperature Min ($T_{s(min)}$)	150°C
	- Temperature Max ($T_{s(max)}$)	200°C
	- Time (min to max) (t_s)	60 – 180 secs
Average ramp up rate (Liquidus) Temp (T_L) to peak		3°C/second max
$T_{s(max)}$ to T_L - Ramp-up Rate		3°C/second max
Reflow	- Temperature (T_L) (Liquidus)	217°C
	- Temperature (t_L)	60 – 150 seconds
Peak Temperature (T_p)		260 ^{+0/-5} °C
Time within 5°C of actual peak Temperature (t_p)		20 – 40 seconds
Ramp-down Rate		6°C/second max
Time 25°C to peak Temperature (T_p)		8 minutes Max.
Do not exceed		260°C

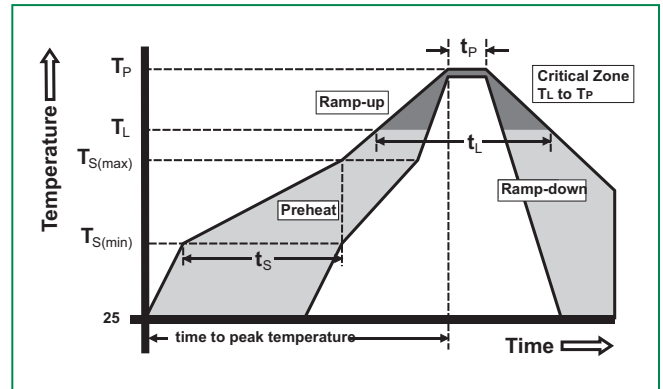

Ordering Information

Part Number	Package	Min. Order Qty.
SP3420-04UTG	μDFN-10 (2.5x1.0mm)	3000

Product Characteristics

Lead Plating	PPF
Lead Material	Copper Alloy
Substrate Material	Silicon
Body Material	Molded Compound
Flammability	UL Recognized compound meeting flammability rating V-0

Part Marking System

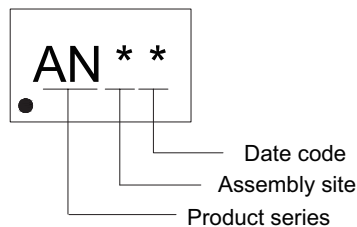

Part Numbering System

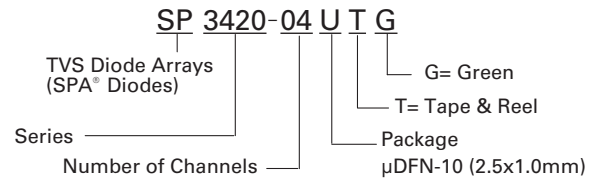

Package Dimensions - μ DFN-10 (2.5x1.0mm)

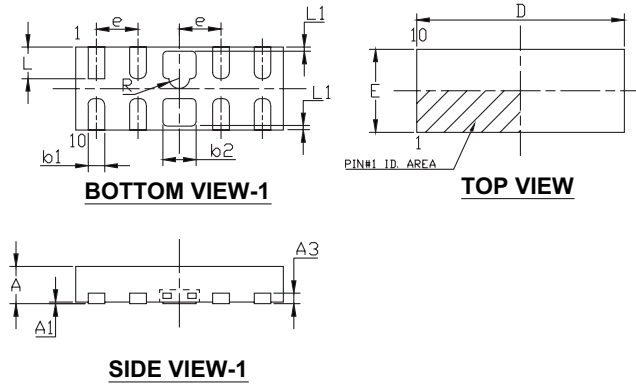

Symbol	Millimeters		Inches	
	Min	Max	Min	Max
A	0.40	0.60	0.013	0.024
A1	0.00	0.05	0.000	0.002
A3	0.127 REF		0.005 REF	
b1	0.15	0.25	0.006	0.010
b2	0.35	0.45	0.014	0.018
D	2.40	2.60	0.094	0.102
E	0.90	1.10	0.035	0.043
e	0.50 BSC		0.020 BSC	
L	0.28	0.48	0.011	0.019
L1	0.00	0.15	0.000	0.006
R	0.125 REF		0.005 REF	

SOLDERING PATTERN

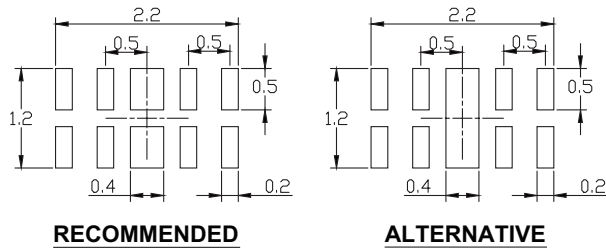

UNIT: mm

Tape & Reel Specification - μ DFN-10 (2.5x1.0mm)

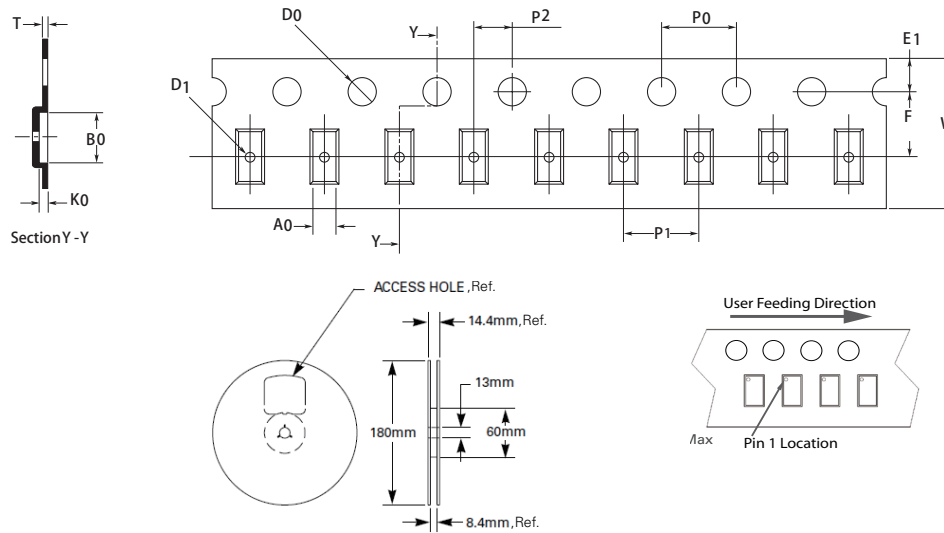

Symbol	Millimeters
A0	1.15 min/1.30 max
B0	2.70+/-0.05
D0	\varnothing 1.50 min/1.65 max
D1	\varnothing 0.50 min/1.05 max
E1	1.75+/-0.10
F	3.50+/-0.10
K0	0.46 min/0.75 max
P0	4.00+/-0.10
P1	4.00+/-0.10
P2	2.00+/-0.05
W	8.00+0.30/-0.10
T	0.17 min/0.30 max

8mm TAPE AND REEL

Disclaimer Notice - Information furnished is believed to be accurate and reliable. However, users should independently evaluate the suitability of and test each product selected for their own applications. Littelfuse products are not designed for, and may not be used in, all applications. Read complete Disclaimer Notice at <http://www.littelfuse.com/disclaimer-electronics>.

单击下面可查看定价，库存，交付和生命周期等信息

[>>Littelfuse\(美国力特\)](#)