

SJxx04xSx Series

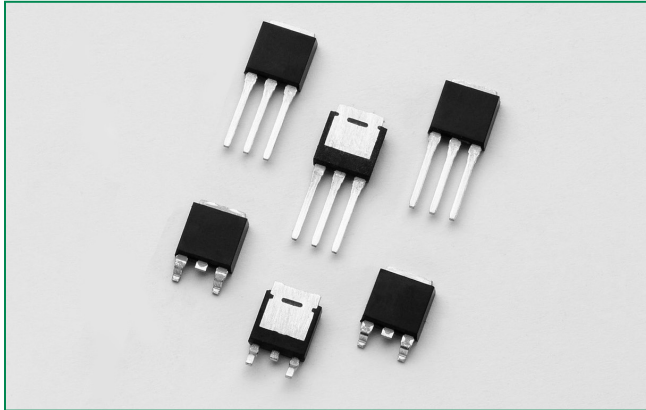

Description

This SJxx04x high temperature SCR series is ideal for uni-directional switch applications such as phase control in heating, motor speed controls, converters/rectifiers and capacitive discharge ignitions

These SCRs have a low gate current trigger level of 20µA maximum at approximately 1.5V.

Features & Benefits

- Voltage capability up to 600V
- Surge capability up to 100A at 60Hz half cycle
- 150°C maximum junction temperature
- Halogen free and RoHS compliant

Main Features

Symbol	Value	Unit
$I_{T(RMS)}$	4	A
V_{DRM}/V_{RRM}	400 or 600	V
I_{GT}	0.2	mA

Schematic Symbol

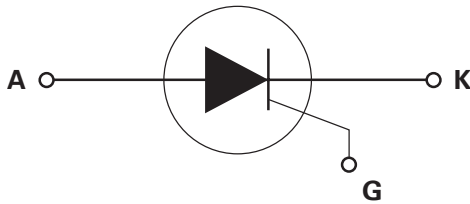

Applications

Typical applications includes capacitive discharge system for motorcycle engine CDI, portable generator engine ignition, strobe lights and nailers, as well as generic rectifiers, battery voltage regulators and converters. Also controls for power tools, home/brown goods and white goods appliances.

Absolute Maximum Ratings – Sensitive SCRs

Symbol	Parameter	Test Conditions	Value	Unit
$I_{T(RMS)}$	RMS on-state current	$T_c = 130^\circ\text{C}$	4	A
$I_{T(AV)}$	Average on-state current	$T_c = 130^\circ\text{C}$	2.56	A
I_{TSM}	Peak non-repetitive surge current	single half cycle; $f = 50\text{ Hz}$; $T_j(\text{initial}) = 25^\circ\text{C}$	25	A
		single half cycle; $f = 60\text{ Hz}$; $T_j(\text{initial}) = 25^\circ\text{C}$	30	
I^2t	I^2t Value for fusing	$t_p = 8.3\text{ ms}$	3.7	A ² s
di/dt	Critical rate of rise of on-state current	$f = 60\text{ Hz}$, $T_j = 150^\circ\text{C}$	50	A/µs
I_{GM}	Peak gate current	$Pw=20\text{ }\mu\text{s}$, $T_j = 150^\circ\text{C}$	0.5	A
$P_{G(AV)}$	Average gate power dissipation	$T_j = 150^\circ\text{C}$	0.1	W
T_{stg}	Storage temperature range		-40 to 150	°C
T_j	Operating junction temperature range		-40 to 150	°C
V_{DSM}/V_{RSM}	Peak non-repetitive blocking voltage	$Pw=100\text{ }\mu\text{s}$	$V_{DRM}/V_{RRM} + 100$	V

Electrical Characteristics ($T_J = 25^\circ\text{C}$, unless otherwise specified) – Sensitive SCRs

Symbol	Test Conditions		Value	Unit
I_{GT}	$V_D = 6V$ $R_L = 100\ \Omega$	MIN.	20	μA
		MAX.	200	μA
V_{GT}		MAX.	0.8	V
dv/dt	$V_D = V_{DRM}$; $R_{GK} = 220\ \Omega$; $T_J = 125^\circ\text{C}$	MIN.	45	V/ μs
V_{GD}	$V_D = V_{DRM}$; $R_L = 3.3\ \text{k}\Omega$; $T_J = 125^\circ\text{C}$	MIN.	0.2	V
	$V_D = V_{DRM}$; $R_L = 3.3\ \text{k}\Omega$; $T_J = 150^\circ\text{C}$	MIN.	0.1	V
V_{GRM}	$I_{GR} = 10\ \mu\text{A}$	MIN.	6	V
I_H	$I_T = 20\text{mA}$ (initial)	MAX.	6	mA
t_q	$t_p = 50\ \mu\text{s}$; $dv/dt = 5\text{V}/\mu\text{s}$; $di/dt = -30\text{A}/\mu\text{s}$	MAX.	60	μs
t_{gt}	$I_G = 2 \times I_{GT}$; $PW = 15\ \mu\text{s}$; $I_T = 8\text{A}$	TYP.	3	μs

Static Characteristics

Symbol	Test Conditions	Value	Unit
V_{TM}	$I_T = 8\text{A}$; $t_p = 380\ \mu\text{s}$	MAX.	1.6 V
I_{DRM} / I_{RRM}	@ V_{DRM} / V_{RRM}	$T_J = 25^\circ\text{C}$ 400 - 600V	MAX. 5 1000 3000 μA
		$T_J = 125^\circ\text{C}$, $R_{GK} = 220\ \Omega$ 400 - 600V	
		$T_J = 150^\circ\text{C}$, $R_{GK} = 220\ \Omega$ 400 - 600V	

Thermal Resistances

Symbol	Parameter	Value	Unit
$R_{\theta(J-C)}$	Junction to case (AC)	1.5	$^\circ\text{C}/\text{W}$

Figure 1: Normalized DC Gate Trigger Current vs. Junction Temperature (Sensitive SCR)

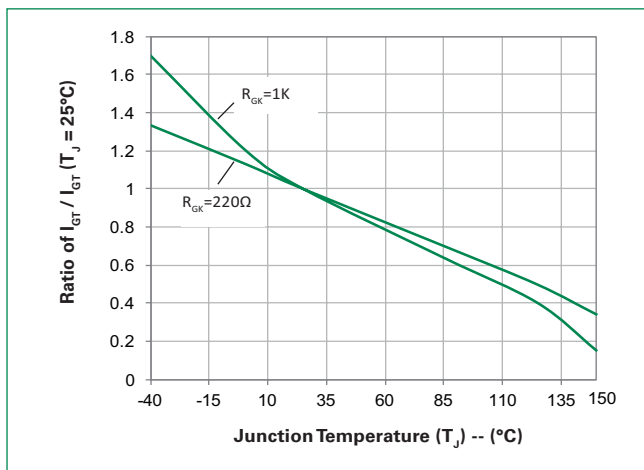

Figure 2: Normalized DC Gate Trigger Voltage vs. Junction Temperature

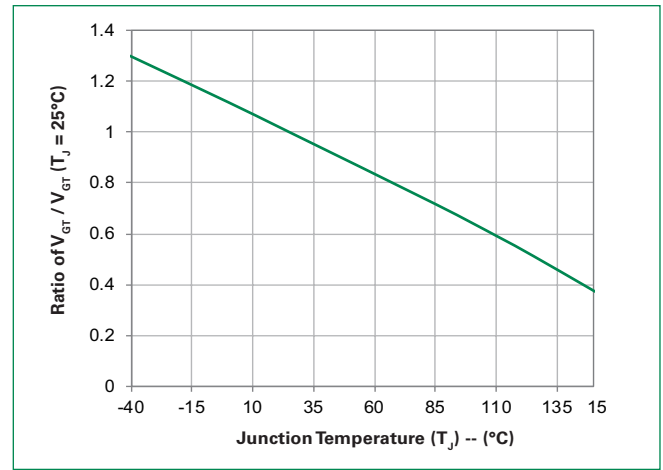

Figure 3: Normalized DC Holding Current vs. Junction Temperature

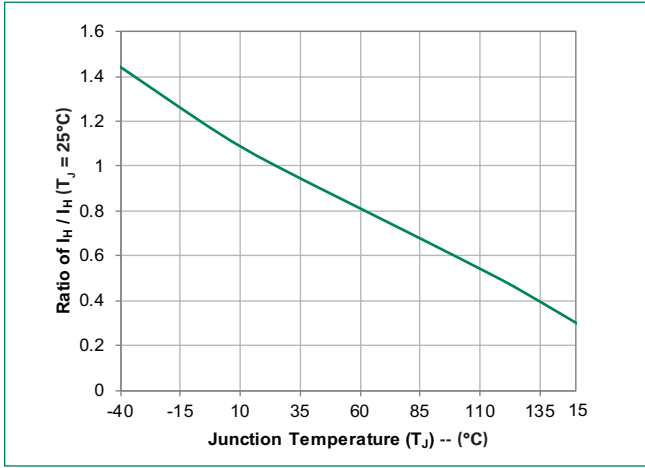

Figure 4: On-State Current vs. On-State Voltage (Typical)

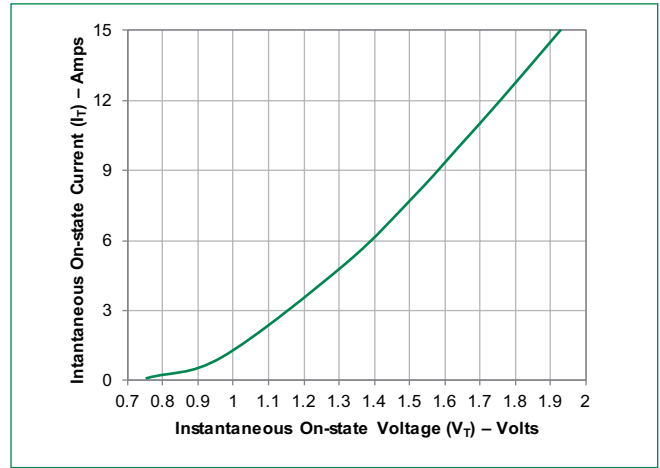

Figure 5: Power Dissipation (Typical) vs. RMS On-State Current

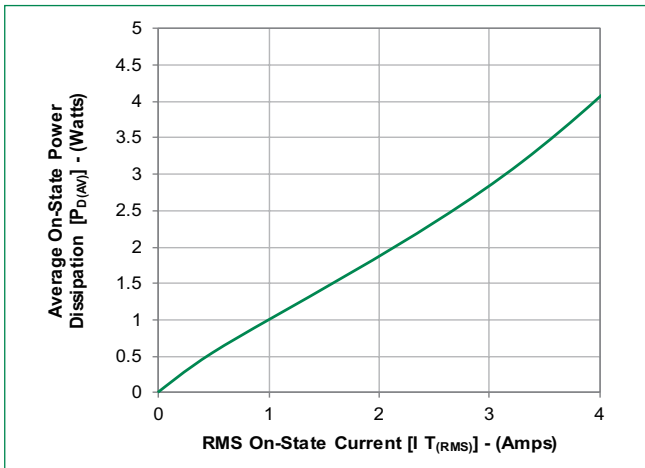

Figure 6: Maximum Allowable Case Temperature vs. RMS On-State Current

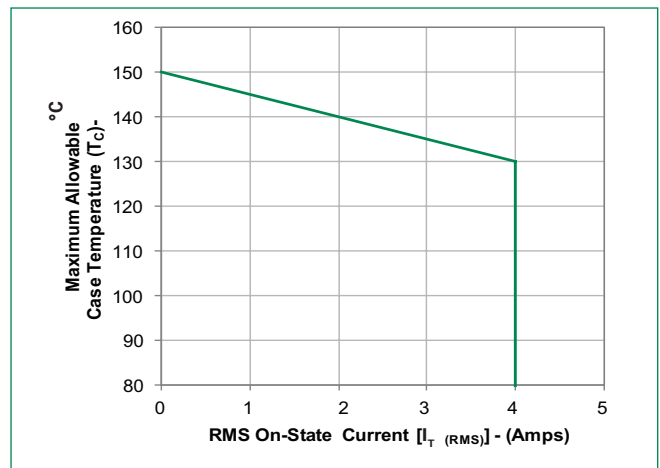

Figure 7: Maximum Allowable Case Temperature vs. Average On-State Current

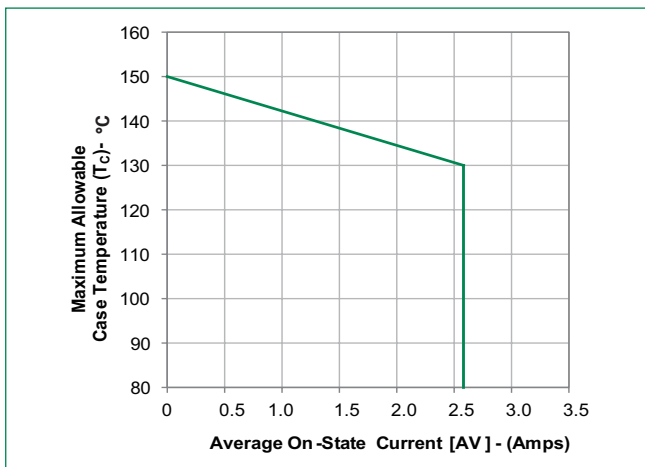

Figure 8: Peak Capacitor Discharge Current

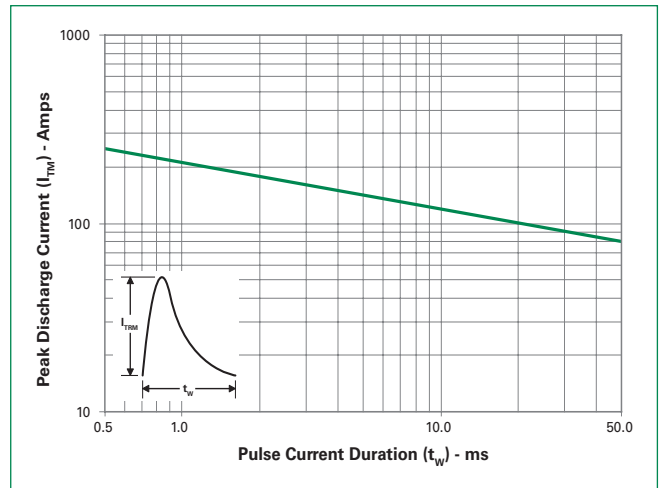

Figure 9: Surge Peak On-State Current vs. Number of Cycles

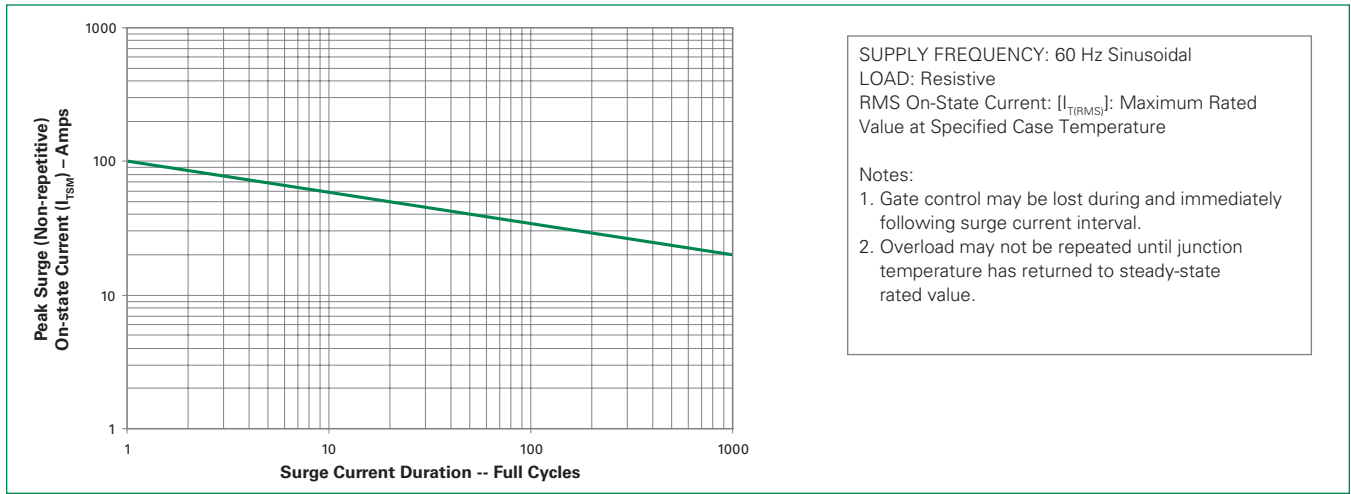

Figure 10: Typical DC Gate Trigger Current with R_{GK} vs. Junction Temperature

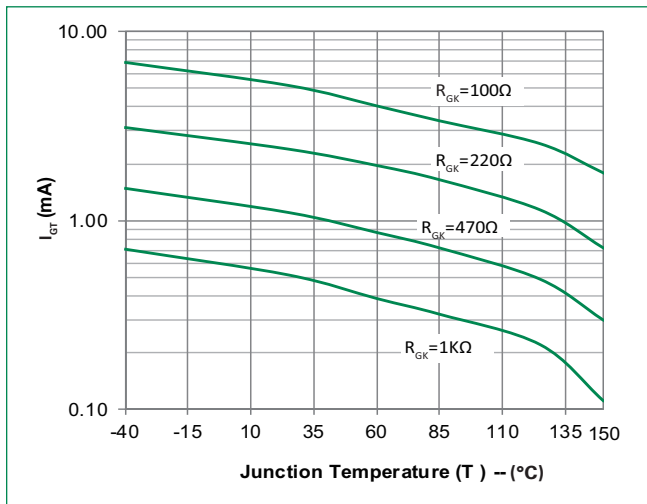

Figure 11: Typical DC Holding Current with R_{GK} vs. Junction Temperature

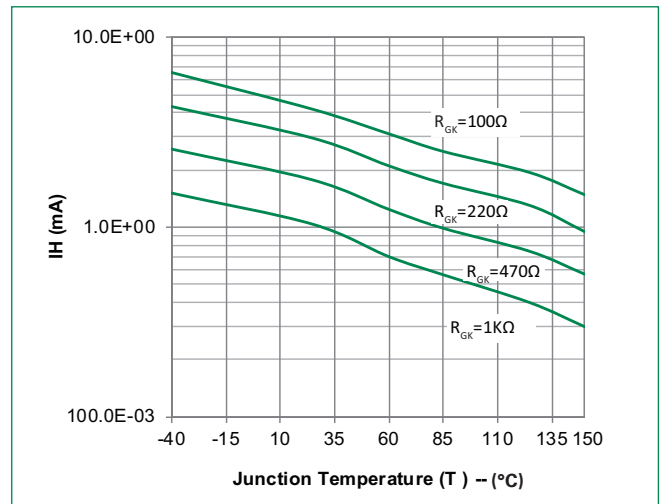
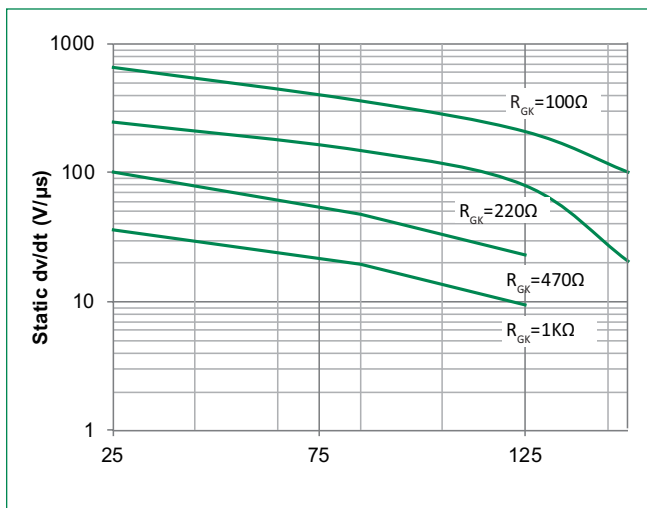

Figure 12: Typical Static dv/dt with R_{GK} vs. Junction Temperature



Soldering Parameters

Reflow Condition		Pb – Free assembly
Pre Heat	- Temperature Min ($T_{s(min)}$)	150°C
	- Temperature Max ($T_{s(max)}$)	200°C
	- Time (min to max) (t_s)	60 – 180 secs
Average ramp up rate (Liquidus Temp (T_L) to peak)		5°C/second max
$T_{s(max)}$ to T_L - Ramp-up Rate		5°C/second max
Reflow	- Temperature (T_L) (Liquidus)	217°C
	- Time (t_L)	60 – 150 seconds
Peak Temperature (T_p)		260 ^{+0/-5} °C
Time within 5°C of actual peak Temperature (t_p)		20 – 40 seconds
Ramp-down Rate		5°C/second max
Time 25°C to peak Temperature (T_p)		8 minutes Max.
Do not exceed		280°C

Physical Specifications

Terminal Finish	100% Matte Tin-plated
Body Material	UL Recognized epoxy meeting flammability rating V-0
Lead Material	Copper Alloy

Design Considerations

Careful selection of the correct component for the application’s operating parameters and environment will go a long way toward extending the operating life of the Thyristor. Good design practice should limit the maximum continuous current through the main terminals to 75% of the component rating. Other ways to ensure long life for a power discrete semiconductor are proper heat sinking and selection of voltage ratings for worst case conditions. Overheating, overvoltage (including dv/dt), and surge currents are the main killers of semiconductors. Correct mounting, soldering, and forming of the leads also help protect against component damage.

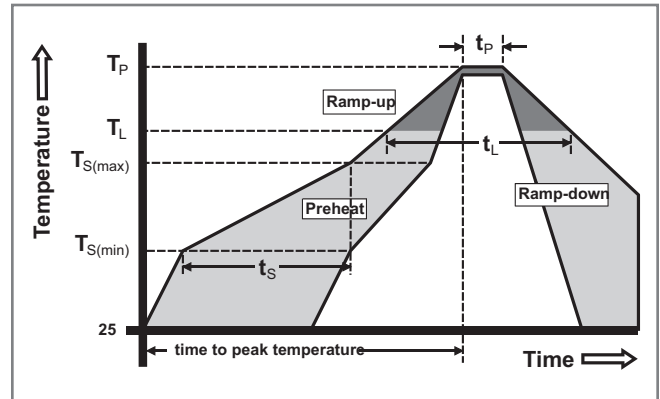

Environmental Specifications

Test	Specifications and Conditions
AC Blocking	MIL-STD-750, M-1040, Cond A Applied Peak AC voltage for 1008 hours
Temperature Cycling	MIL-STD-750, M-1051, 100 cycles; -40°C to +150°C; 15-min dwell-time
Temperature/Humidity	EIA / JEDEC, JESD22-A101 1008 hours; 160V - DC: 85°C; 85% rel humidity
High Temp Storage	MIL-STD-750, M-1031, 1008 hours; 150°C
Low-Temp Storage	1008 hours; -40°C
Resistance to Solder Heat	MIL-STD-750 Method 2031
Solderability	ANSI/J-STD-002, category 3, Test A
Lead Bend	MIL-STD-750, M-2036 Cond E
Moisture Sensitivity Level	Level 1, JEDEC-J-STD-020

Dimensions — TO-251AA (V/I-Package) — V/I-PAK Through Hole

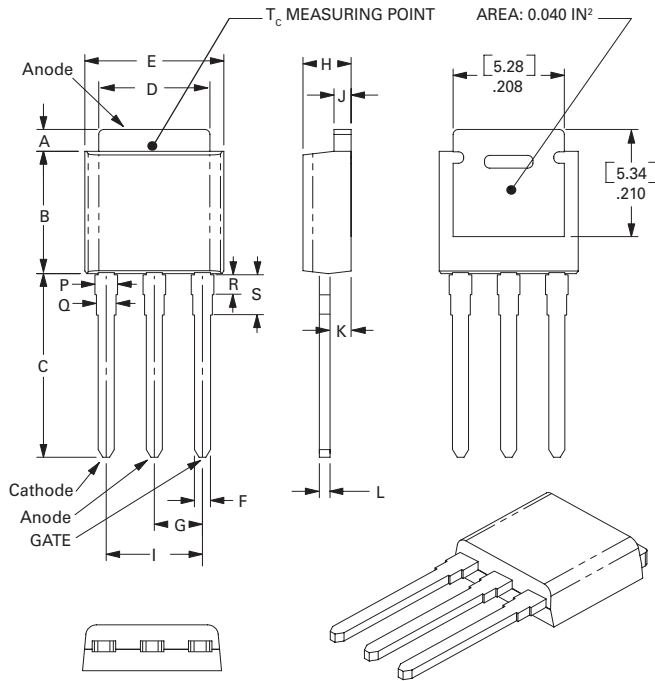

Dimension	Inches			Millimeters		
	Min	Typ	Max	Min	Typ	Max
A	0.037	0.040	0.043	0.94	1.01	1.09
B	0.235	0.242	0.245	5.97	6.15	6.22
C	0.350	0.361	0.375	8.89	9.18	9.53
D	0.205	0.208	0.213	5.21	5.29	5.41
E	0.255	0.262	0.265	6.48	6.66	6.73
F	0.027	0.031	0.033	0.69	0.80	0.84
G	0.087	0.090	0.093	2.21	2.28	2.36
H	0.085	0.092	0.095	2.16	2.34	2.41
I	0.176	0.180	0.184	4.47	4.57	4.67
J	0.018	0.020	0.023	0.46	0.51	0.58
K	0.035	0.037	0.039	0.90	0.95	1.00
L	0.018	0.020	0.023	0.46	0.52	0.58
P	0.042	0.047	0.052	1.06	1.20	1.32
Q	0.034	0.039	0.044	0.86	1.00	1.11
R	0.034	0.039	0.044	0.86	1.00	1.11
S	0.074	0.079	0.084	1.86	2.00	2.11

Dimensions — TO-252AA (D-Package) — D-PAK Surface Mount

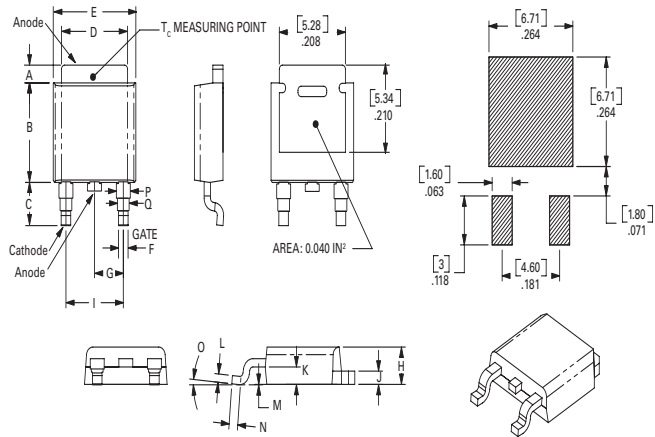

Dimension	Inches			Millimeters		
	Min	Typ	Max	Min	Typ	Max
A	0.037	0.040	0.043	0.94	1.01	1.09
B	0.235	0.243	0.245	5.97	6.16	6.22
C	0.106	0.108	0.113	2.69	2.74	2.87
D	0.205	0.208	0.213	5.21	5.29	5.41
E	0.255	0.262	0.265	6.48	6.65	6.73
F	0.027	0.031	0.033	0.69	0.80	0.84
G	0.087	0.090	0.093	2.21	2.28	2.36
H	0.085	0.092	0.095	2.16	2.33	2.41
I	0.176	0.179	0.184	4.47	4.55	4.67
J	0.018	0.020	0.023	0.46	0.51	0.58
K	0.035	0.037	0.039	0.90	0.95	1.00
L	0.018	0.020	0.023	0.46	0.51	0.58
M	0.000	0.000	0.004	0.00	0.00	0.10
N	0.021	0.026	0.027	0.53	0.67	0.69
O	0°	0°	5°	0°	0°	5°
P	0.042	0.047	0.052	1.06	1.20	1.32
Q	0.034	0.039	0.044	0.86	1.00	1.11

TO-252 Embossed Carrier Reel Pack (RP) Specifications

Meets all EIA-481-2 Standards

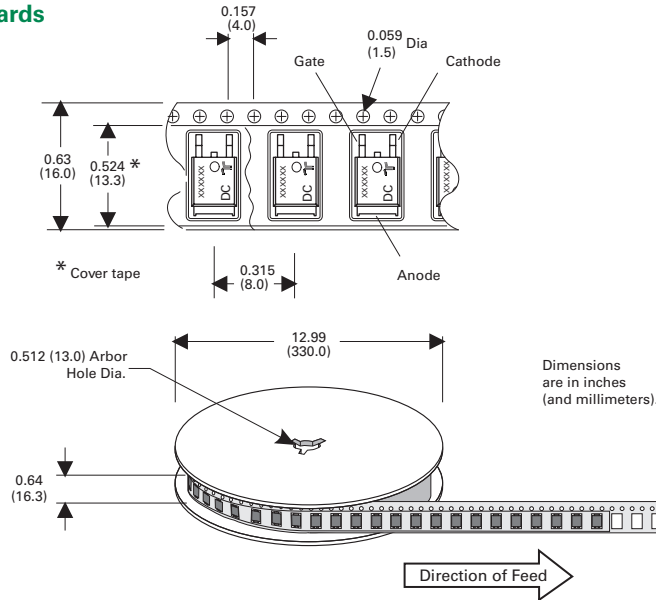

Product Selector

Part Number	Voltage		Gate Sensitivity	Type	Package
	400V	600V			
SJxx04VS2	X	X	0.2mA	Sensitive SCR	TO-251
SJxx04DS2	X	X	0.2mA	Sensitive SCR	TO-252

Note: xx = Voltage

Packing Options

Part Number	Marking	Weight	Packing Mode	Base Quantity
SJxx04DS2TP	SJxx04DS2	0.3 g	Tube	750 (75 per tube)
SJxx04DS2RP	SJxx04DS2	0.3 g	Embossed Carrier	2500
SJxx04VS2TP	SJxx04VS2	0.4 g	Tube	750 (75 per tube)

Note: xx = Voltage

Part Numbering System

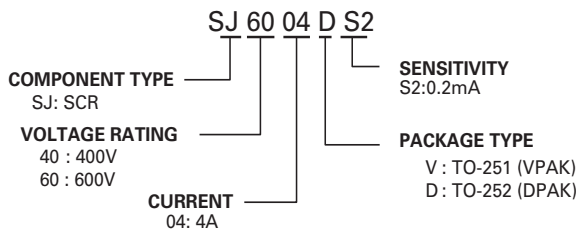

Part Marking System

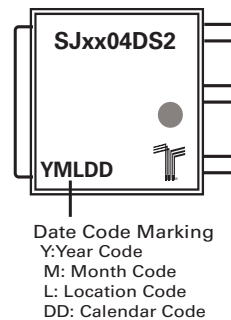

Disclaimer Notice - Information furnished is believed to be accurate and reliable. However, users should independently evaluate the suitability of and test each product selected for their own applications. Littelfuse products are not designed for, and may not be used in, all applications. Read complete Disclaimer Notice at www.littelfuse.com/disclaimer-electronics.

单击下面可查看定价，库存，交付和生命周期等信息

[>>Littelfuse\(美国力特\)](#)