

# PolarHV™ HiPerFET Power MOSFET

IXFK 64N50P  
IXFX 64N50P

$V_{DSS} = 500 \text{ V}$   
 $I_{D25} = 64 \text{ A}$   
 $R_{DS(on)} \leq 85 \text{ m}\Omega$   
 $t_{rr} \leq 200 \text{ ns}$

N-Channel Enhancement Mode  
 Avalanche Rated  
 Fast Intrinsic Diode



Symbol	Test Conditions	Maximum Ratings	
$V_{DSS}$	$T_J = 25^\circ\text{C}$ to $150^\circ\text{C}$	500	V
$V_{DGR}$	$T_J = 25^\circ\text{C}$ to $150^\circ\text{C}$ ; $R_{GS} = 1 \text{ M}\Omega$	500	V
$V_{GSS}$	Continuous	$\pm 30$	V
$V_{GSM}$	Transient	$\pm 40$	V
$I_{D25}$	$T_C = 25^\circ\text{C}$	64	A
$I_{DM}$	$T_C = 25^\circ\text{C}$ , pulse width limited by $T_{JM}$	150	A
$I_{AR}$	$T_C = 25^\circ\text{C}$	64	A
$E_{AR}$	$T_C = 25^\circ\text{C}$	80	mJ
$E_{AS}$	$T_C = 25^\circ\text{C}$	2.5	J
dv/dt	$I_S \leq I_{DM}$ , di/dt $\leq 100 \text{ A}/\mu\text{s}$ , $V_{DD} \leq V_{DSS}$ , $T_J \leq 150^\circ\text{C}$ , $R_G = 4 \Omega$	20	V/ns
$P_D$	$T_C = 25^\circ\text{C}$	830	W
$T_J$		-55 ... +150	$^\circ\text{C}$
$T_{JM}$		150	$^\circ\text{C}$
$T_{stg}$		-55 ... +150	$^\circ\text{C}$
$M_d$	Mounting torque (TO-264)	1.13/10 Nm/lb.in.	
Weight	TO-264	10	g
	PLUS247	6	g
$T_L$	1.6 mm (0.062 in.) from case for 10 s	300	$^\circ\text{C}$
$T_{SOLD}$	Plastic body for 10 s	260	$^\circ\text{C}$

TO-264 (IXFK)

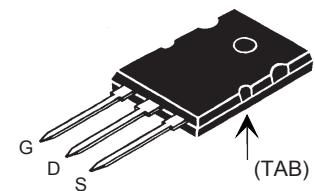

PLUS247 (IXFX)

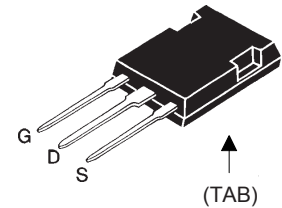

G = Gate      D = Drain  
 S = Source    Tab = Drain

## Features

- | International standard packages
- | Fast recovery diode
- | Unclamped Inductive Switching (UIS) rated
- | Low package inductance
- easy to drive and to protect

## Advantages

- | Easy to mount
- | Space savings
- | High power density

Symbol	Test Conditions ( $T_J = 25^\circ\text{C}$ , unless otherwise specified)	Characteristic Values		
		Min.	Typ.	Max.
$BV_{DSS}$	$V_{GS} = 0 \text{ V}$ , $I_D = 250 \mu\text{A}$	500		V
$V_{GS(th)}$	$V_{DS} = V_{GS}$ , $I_D = 8 \text{ mA}$	3.0		5.5 V
$I_{GSS}$	$V_{GS} = \pm 30 \text{ V}_{DC}$ , $V_{DS} = 0$			$\pm 200 \text{ nA}$
$I_{DSS}$	$V_{DS} = V_{DSS}$ $V_{GS} = 0 \text{ V}$ $T_J = 125^\circ\text{C}$			25 $\mu\text{A}$
				1000 $\mu\text{A}$
$R_{DS(on)}$	$V_{GS} = 10 \text{ V}$ , $I_D = 0.5 I_{D25}$ Pulse test, $t \leq 300 \mu\text{s}$ , duty cycle $d \leq 2 \%$			85 $\text{m}\Omega$

Symbol	Test Conditions	Characteristic Values ( $T_J = 25^\circ\text{C}$ , unless otherwise specified)		
		Min.	Typ.	Max.
$g_{fs}$	$V_{DS} = 20\text{ V}; I_D = 0.5 I_{D25}$ , pulse test	30	50	S
$C_{iss}$	$V_{GS} = 0\text{ V}, V_{DS} = 25\text{ V}, f = 1\text{ MHz}$		8700	pF
$C_{oss}$			970	pF
$C_{rss}$			90	pF
$t_{d(on)}$	$V_{GS} = 10\text{ V}, V_{DS} = 0.5 V_{DSS}, I_D = 0.5 I_{D25}$ $R_G = 2\ \Omega$ (External)		30	ns
$t_r$			25	ns
$t_{d(off)}$			85	ns
$t_f$			22	ns
$Q_{g(on)}$	$V_{GS} = 10\text{ V}, V_{DS} = 0.5 V_{DSS}, I_D = 0.5 I_{D25}$		150	nC
$Q_{gs}$			50	nC
$Q_{gd}$			50	nC
$R_{thJC}$			0.15	$^\circ\text{C/W}$
$R_{thCS}$			0.15	$^\circ\text{C/W}$

### Source-Drain Diode

Symbol	Test Conditions	Characteristic Values ( $T_J = 25^\circ\text{C}$ , unless otherwise specified)		
		Min.	Typ.	Max.
$I_S$	$V_{GS} = 0\text{ V}$			64 A
$I_{SM}$	Repetitive			150 A
$V_{SD}$	$I_F = I_S, V_{GS} = 0\text{ V}$ , Pulse test, $t \leq 300\ \mu\text{s}$ , duty cycle $d \leq 2\%$			1.5 V
$t_{rr}$	$I_F = 25\text{ A}, -di/dt = 100\text{ A}/\mu\text{s}$ $V_R = 100\text{ V}$			200 ns
$Q_{RM}$			0.6	$\mu\text{C}$
$I_{RM}$			6.0	A

### PLUS 247™ (IXFX) Outline

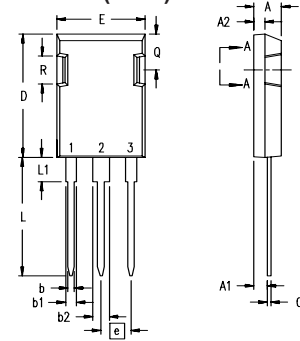

Terminals: 1 - Gate  
2 - Drain (Collector)  
3 - Source (Emitter)  
4 - Drain (Collector)

Dim.	Millimeter		Inches	
	Min.	Max.	Min.	Max.
A	4.83	5.21	.190	.205
A <sub>1</sub>	2.29	2.54	.090	.100
A <sub>2</sub>	1.91	2.16	.075	.085
b	1.14	1.40	.045	.055
b <sub>1</sub>	1.91	2.13	.075	.084
b <sub>2</sub>	2.92	3.12	.115	.123
C	0.61	0.80	.024	.031
D	20.80	21.34	.819	.840
E	15.75	16.13	.620	.635
e	5.45 BSC		.215 BSC	
L	19.81	20.32	.780	.800
L1	3.81	4.32	.150	.170
Q	5.59	6.20	.220	0.244
R	4.32	4.83	.170	.190

### TO-264 (IXFK) Outline

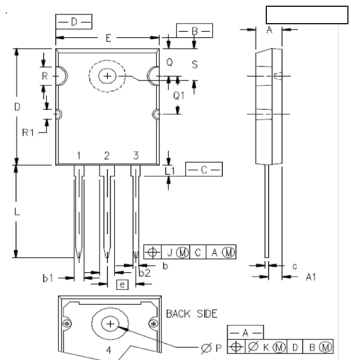

1 - GATE  
2, 4 - DRAIN (COLLECTOR)  
3 - SOURCE (EMITTER)

SYM	INCHES		MILLIMETERS	
	MIN	MAX	MIN	MAX
A	.185	.209	4.70	5.31
A1	.102	.118	2.59	3.00
b	.037	.055	0.94	1.40
b1	.087	.102	2.21	2.59
b2	.110	.126	2.79	3.20
c	.017	.029	0.43	0.74
D	1.007	1.047	25.58	26.59
E	.760	.799	19.30	20.29
e	.215BSC		5.46 BSC	
J	.000	.010	0.00	0.25
K	.000	.010	0.00	0.25
L	.779	.842	19.79	21.39
L1	.087	.102	2.21	2.59
ØP	.122	.138	3.10	3.51
Q	.240	.256	6.10	6.50
Q1	.330	.346	8.38	8.79
ØR	.155	.187	3.94	4.75
ØR1	.085	.093	2.16	2.36
S	.243	.253	6.17	6.43

IXYS reserves the right to change limits, test conditions, and dimensions.

IXYS MOSFETs and IGBTs are covered by 4,835,592 4,931,844 5,049,961 5,237,481 6,162,665 6,404,065 B1 6,683,344 6,727,585  
one or more of the following U.S. patents: 4,850,072 5,017,508 5,063,307 5,381,025 6,259,123 B1 6,534,343 6,710,405B2 6,759,692  
4,881,106 5,034,796 5,187,117 5,486,715 6,306,728 B1 6,583,505 6,710,463 6,771,478 B2

**Fig. 1. Output Characteristics**  
@ 25°C

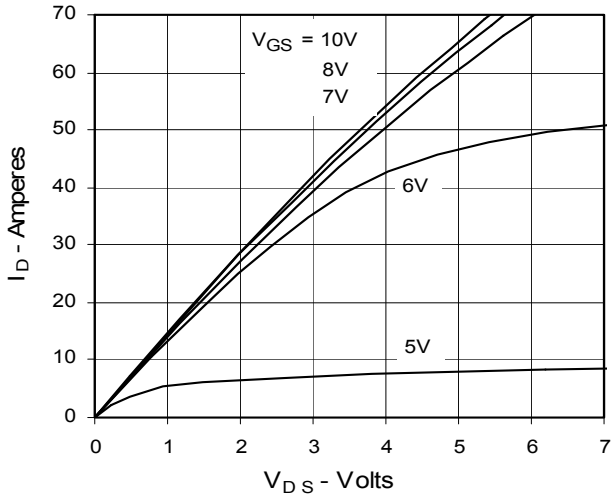

**Fig. 2. Extended Output Characteristics**  
@ 25°C

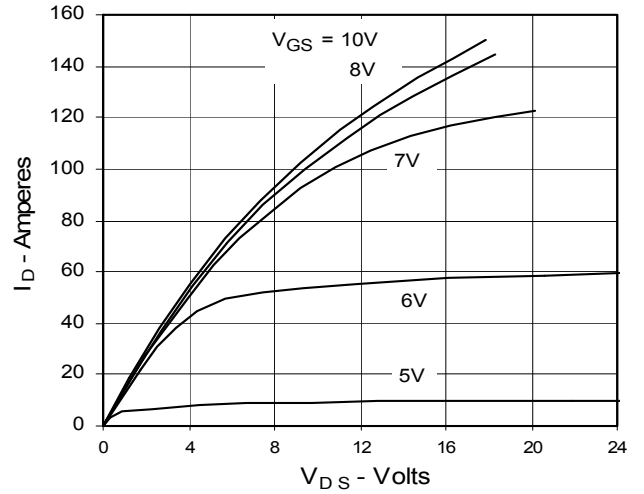

**Fig. 3. Output Characteristics**  
@ 125°C

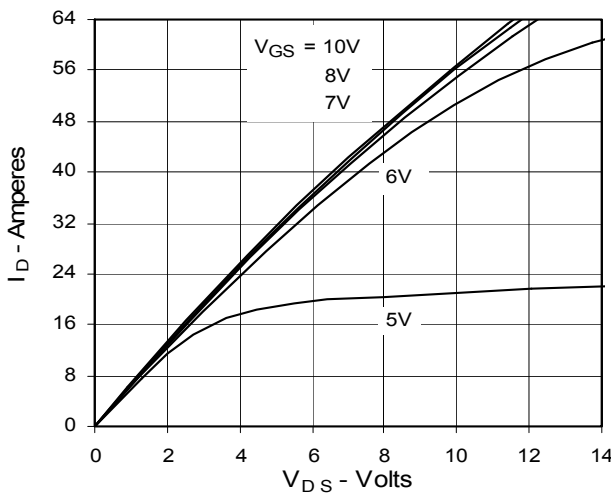

**Fig. 4.  $R_{DS(on)}$  Normalized to 0.5  $I_{D25}$  Value vs. Junction Temperature**

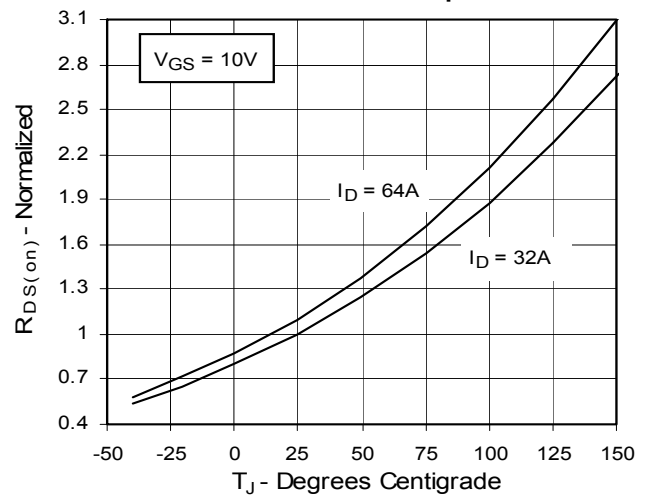

**Fig. 5.  $R_{DS(on)}$  Normalized to 0.5  $I_{D25}$  Value vs.  $I_D$**

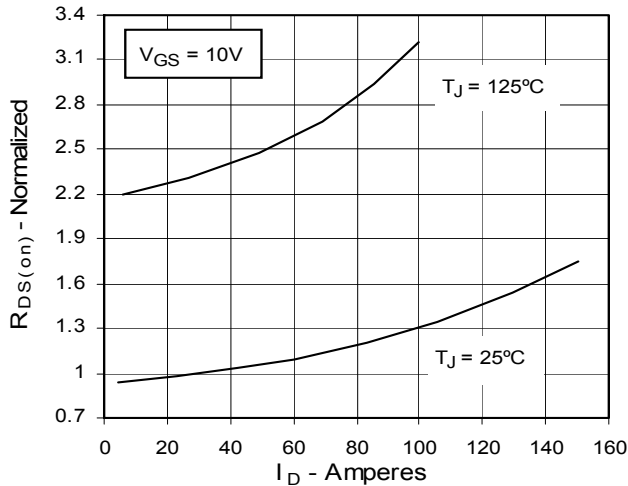

**Fig. 6. Drain Current vs. Case Temperature**

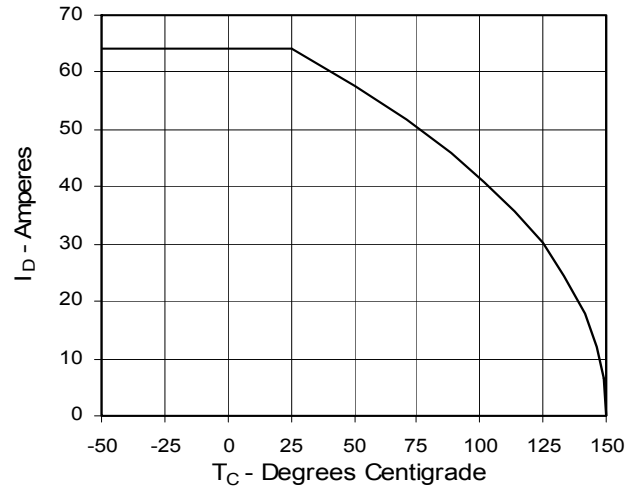

**Fig. 7. Input Admittance**

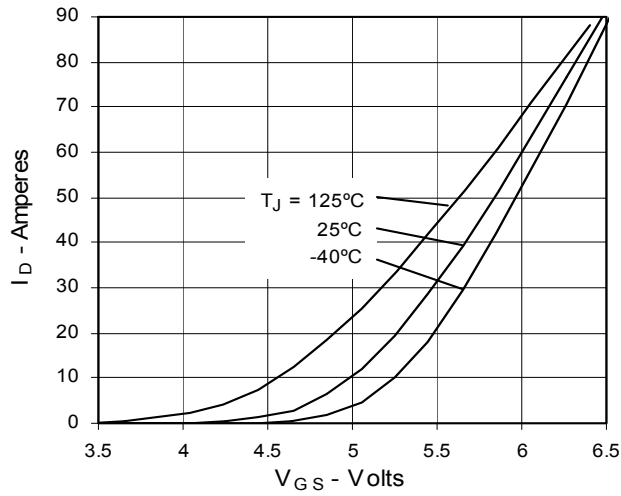

**Fig. 8. Transconductance**

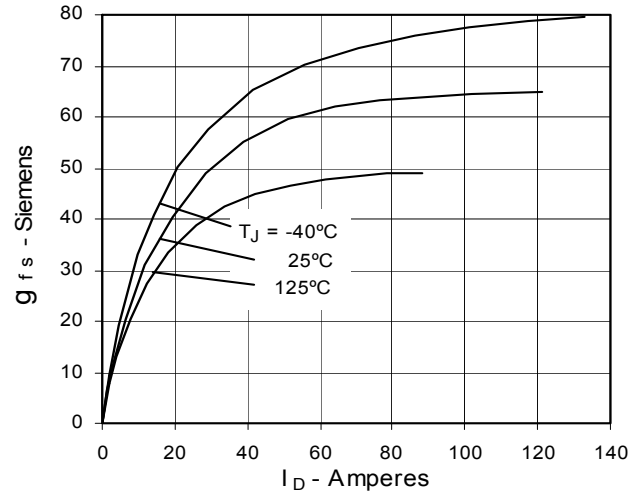

**Fig. 9. Source Current vs. Source-To-Drain Voltage**

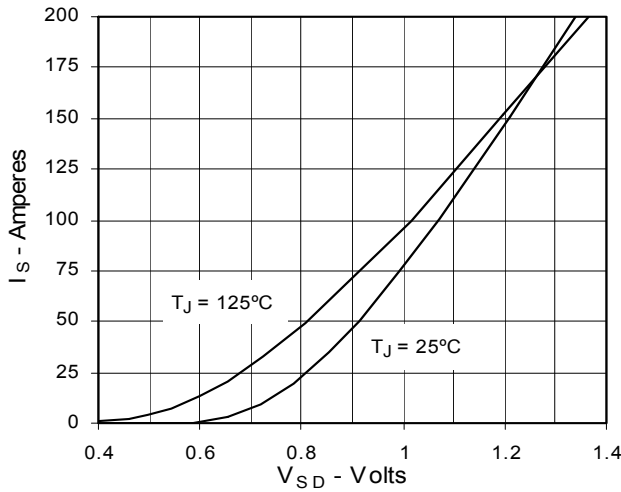

**Fig. 10. Gate Charge**

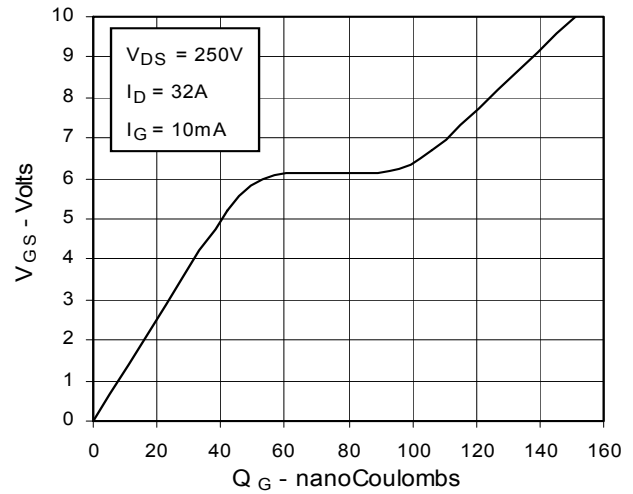

**Fig. 11. Capacitance**

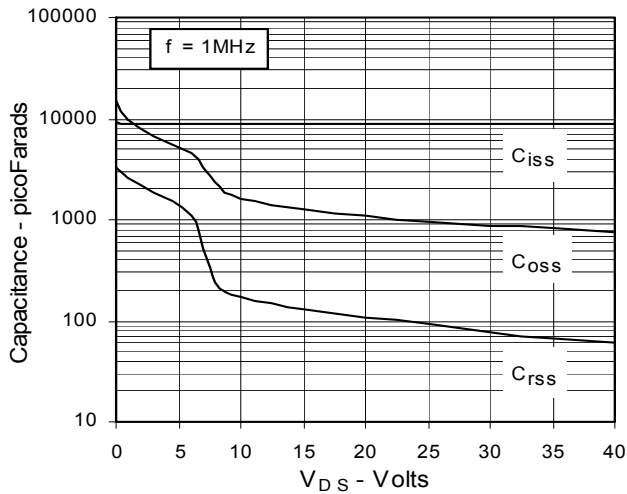

**Fig. 12. Maximum Transient Thermal Resistance**

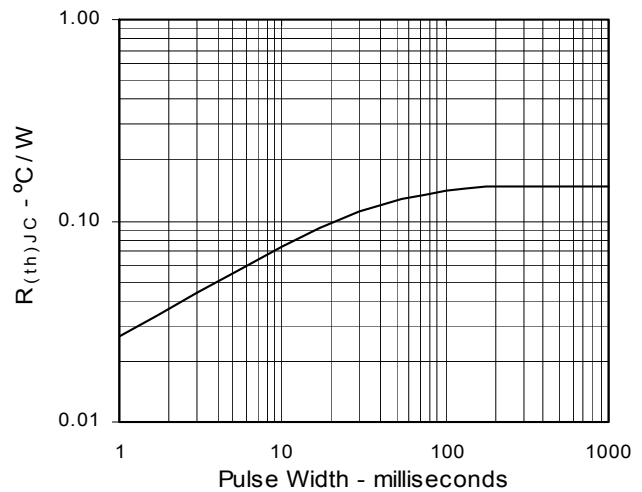

单击下面可查看定价，库存，交付和生命周期等信息

[>>Littelfuse\(美国力特\)](#)