

# High Efficiency Standard Rectifier

$$V_{RRM} = 2 \times 800 \text{ V}$$

$$I_{FAV} = 5 \text{ A}$$

$$V_F = 1.12 \text{ V}$$

Phase leg

Part number

**DLA5P800UC**

Marking on Product: M5RLUP

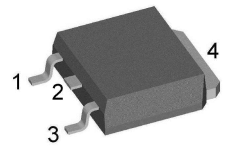

Backside: anode/cathode

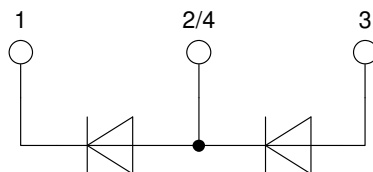

### Features / Advantages:

- Planar passivated chips
- Very low leakage current
- Very low forward voltage drop
- Improved thermal behaviour

### Applications:

- Diode for main rectification
- For single and three phase bridge configurations

### Package: TO-252 (DPak)

- Industry standard outline
- RoHS compliant
- Epoxy meets UL 94V-0

### Disclaimer Notice

Information furnished is believed to be accurate and reliable. However, users should independently evaluate the suitability of and test each product selected for their own applications. Littelfuse products are not designed for, and may not be used in, all applications. Read complete Disclaimer Notice at [www.littelfuse.com/disclaimer-electronics](http://www.littelfuse.com/disclaimer-electronics).



Rectifier				Ratings			
Symbol	Definition	Conditions	min.	typ.	max.	Unit	
$V_{RSM}$	max. non-repetitive reverse blocking voltage	$T_{VJ} = 25^{\circ}C$			900	V	
$V_{RRM}$	max. repetitive reverse blocking voltage	$T_{VJ} = 25^{\circ}C$			800	V	
$I_R$	reverse current	$V_R = 800 V$	$T_{VJ} = 25^{\circ}C$		5	$\mu A$	
		$V_R = 800 V$	$T_{VJ} = 150^{\circ}C$		0.05	mA	
$V_F$	forward voltage drop	$I_F = 5 A$	$T_{VJ} = 25^{\circ}C$		1.18	V	
		$I_F = 10 A$			1.38	V	
		$I_F = 5 A$	$T_{VJ} = 150^{\circ}C$		1.12	V	
		$I_F = 10 A$			1.41	V	
$I_{FAV}$	average forward current	$T_C = 155^{\circ}C$ 180° sine	$T_{VJ} = 175^{\circ}C$		5	A	
$V_{F0}$	threshold voltage	} for power loss calculation only	$T_{VJ} = 175^{\circ}C$		0.82	V	
$r_F$	slope resistance				58	m $\Omega$	
$R_{thJC}$	thermal resistance junction to case				2.5	K/W	
$R_{thCH}$	thermal resistance case to heatsink			0.5		K/W	
$P_{tot}$	total power dissipation		$T_C = 25^{\circ}C$		60	W	
$I_{FSM}$	max. forward surge current	t = 10 ms; (50 Hz), sine	$T_{VJ} = 45^{\circ}C$		70	A	
		t = 8,3 ms; (60 Hz), sine	$V_R = 0 V$		76	A	
		t = 10 ms; (50 Hz), sine	$T_{VJ} = 150^{\circ}C$		60	A	
		t = 8,3 ms; (60 Hz), sine	$V_R = 0 V$		64	A	
$I^2t$	value for fusing	t = 10 ms; (50 Hz), sine	$T_{VJ} = 45^{\circ}C$		25	A <sup>2</sup> s	
		t = 8,3 ms; (60 Hz), sine	$V_R = 0 V$		24	A <sup>2</sup> s	
		t = 10 ms; (50 Hz), sine	$T_{VJ} = 150^{\circ}C$		18	A <sup>2</sup> s	
		t = 8,3 ms; (60 Hz), sine	$V_R = 0 V$		17	A <sup>2</sup> s	
$C_J$	junction capacitance	$V_R = 400 V; f = 1 MHz$	$T_{VJ} = 25^{\circ}C$		1	pF	



Package TO-252 (DPak)			Ratings			
Symbol	Definition	Conditions	min.	typ.	max.	Unit
$I_{RMS}$	RMS current	per terminal			20	A
$T_{VJ}$	virtual junction temperature		-55		175	°C
$T_{op}$	operation temperature		-55		150	°C
$T_{stg}$	storage temperature		-55		150	°C
<b>Weight</b>				0.3		g
$F_C$	mounting force with clip		20		60	N

**Product Marking**



**Part description**

- D = Diode
- L = Low Voltage Standard Rectifier
- A = (up to 1200V)
- 5 = Current Rating [A]
- P = Phase leg
- 800 = Reverse Voltage [V]
- UC = TO-252AA (DPak)

Ordering	Ordering Number	Marking on Product	Delivery Mode	Quantity	Code No.
Standard	DLA5P800UC-TRL	M5RLUP	Tape & Reel	2500	511574
Alternative	DLA5P800UC-TUB	M5RLUP	Tube	70	523442

**Equivalent Circuits for Simulation**

\* on die level

$T_{VJ} = 175\text{ °C}$

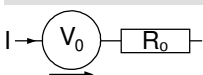

**Rectifier**

$V_{0\ max}$	threshold voltage	0.82	V
$R_{0\ max}$	slope resistance *	55	mΩ



**Outlines TO-252 (DPak)**

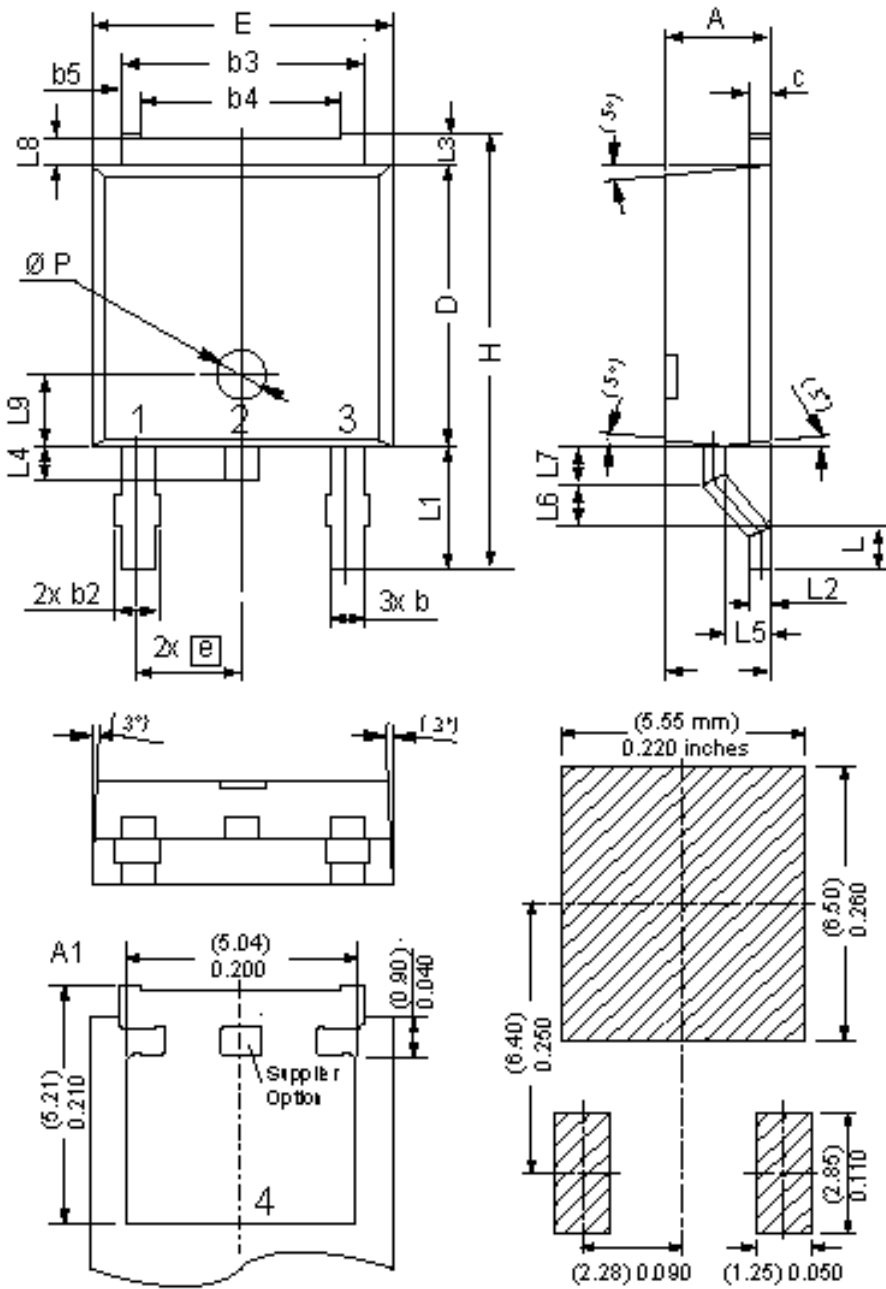

Dim	Millimeters		Inches	
	min	max	min	max
A	2.20	2.40	0.087	0.094
A1	2.10	2.50	0.083	0.098
b	0.66	0.86	0.026	0.034
b2	-	0.96	-	0.038
b3	5.04	5.64	0.198	0.222
b4	4.34 BSC		0.171 BSC	
b5	0.50 BSC		0.020 BSC	
c	0.40	0.86	0.016	0.034
D	5.90	6.30	0.232	0.248
E	6.40	6.80	0.252	0.268
e	2.10	2.50	0.083	0.098
H	9.20	10.10	0.362	0.398
L	0.55	1.28	0.022	0.050
L1	2.50	2.90	0.098	0.114
L2	0.40	0.60	0.016	0.024
L3	0.50	0.90	0.020	0.035
L4	0.60	1.00	0.024	0.039
L5	0.82	1.22	0.032	0.048
L6	0.79	0.99	0.031	0.039
L7	0.81	1.01	0.032	0.040
L8	0.40	0.80	0.016	0.031
L9	1.50 BSC		0.059 BSC	
Ø P	1.00 BSC		0.039 BSC	

Recommended  
min. foot print





**Rectifier**

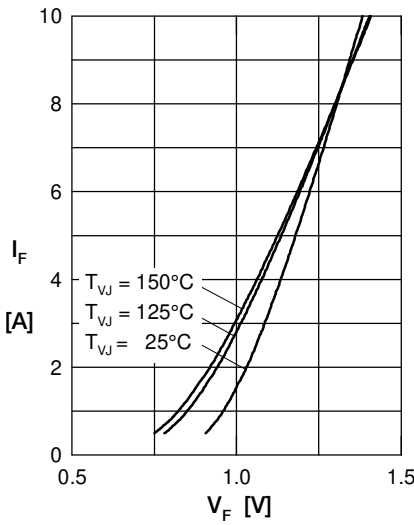

Fig. 1 Forward current versus voltage drop

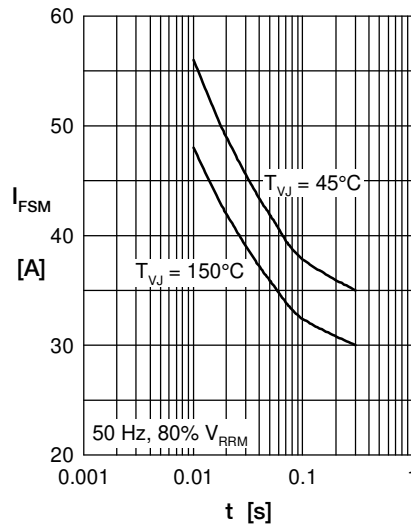

Fig. 2 Surge overload current

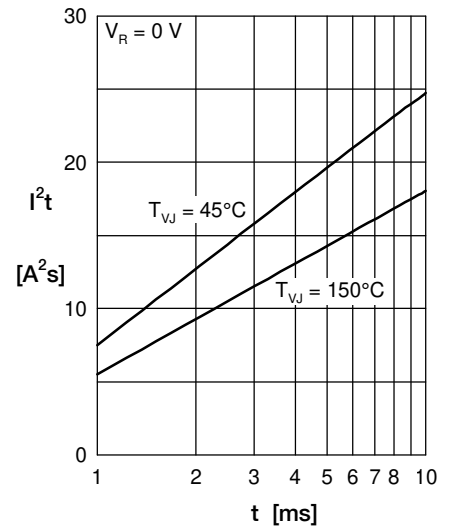

Fig. 3  $I^2t$  versus time

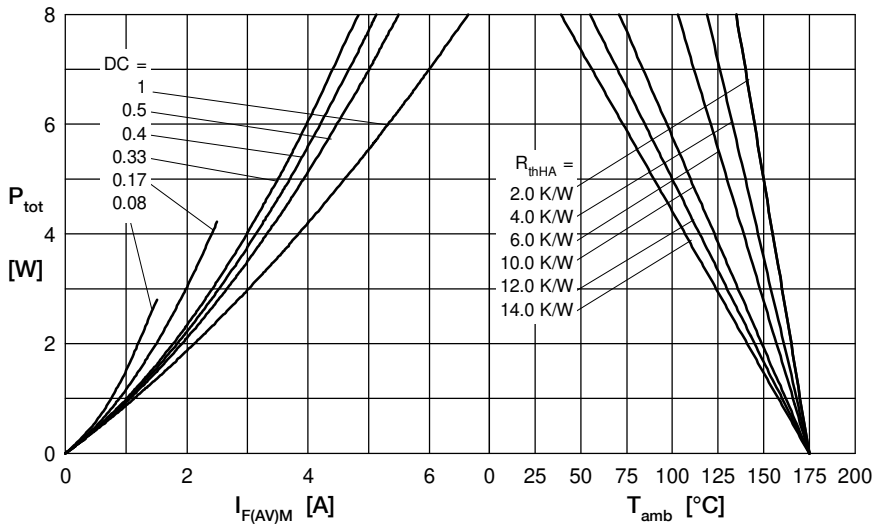

Fig. 4 Power dissipation versus direct output current and ambient temperature

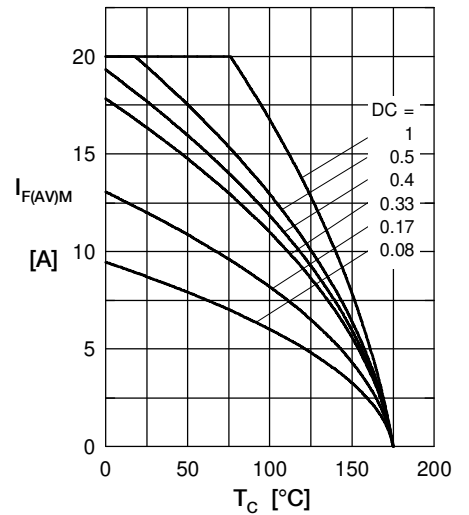

Fig. 5 Max. forward current vs. case temperature

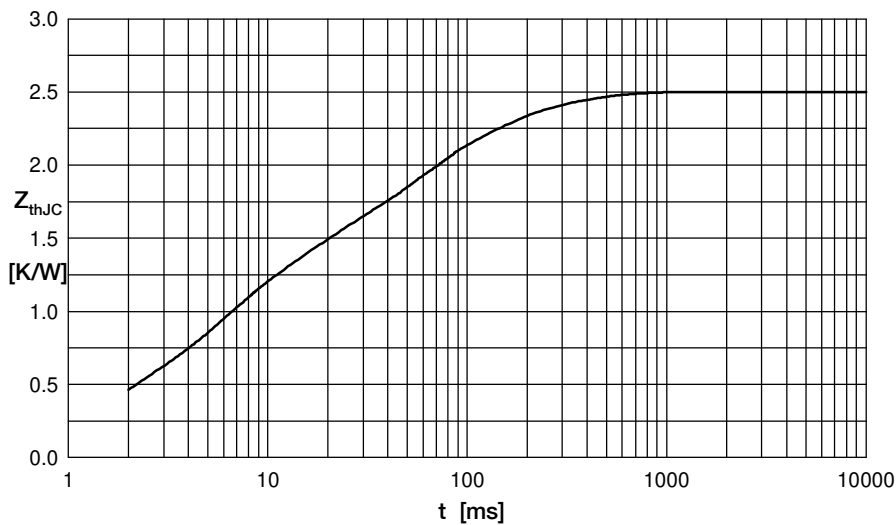

Fig. 6 Transient thermal impedance junction to case

Constants for  $Z_{thJC}$  calculation:

i	$R_{thi}$ (K/W)	$t_i$ (s)
1	1.1	0.005
2	0.06	0.0003
3	0.2	0.045
4	0.4	0.2
5	0.74	0.05

单击下面可查看定价，库存，交付和生命周期等信息

[>>Littelfuse\(美国力特\)](#)