

SPxx Series 100W Discrete Bidirectional TVS Diode

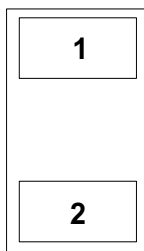

Pinout



Functional Block Diagram

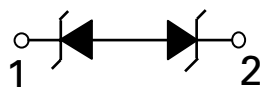

Life Support Note:

Not Intended for Use in Life Support or Life Saving Applications

The products shown herein are not designed for use in life sustaining or life saving applications unless otherwise expressly indicated.

Description

The SPxx-01WTG-C-HV series is designed to replace multilayer varistors (MLVs) in portable applications, LED lighting modules, and low speed I/Os. It will protect sensitive equipment from damage due to electrostatic discharge (ESD) and other overvoltage transients.

The SPxx-01WTG-C-HV series can safely absorb repetitive ESD strikes above the maximum level of the IEC 61000-4-2 international standard (Level 4, ±8kV contact discharge) without performance degradation and safely dissipate up to 8A (SP12-01WTG-C-HV) of induced surge current (IEC 61000-4-5, $t_p=8/20\mu s$) with very low clamping voltages.

Features

- ESD, IEC 61000-4-2, ±30kV contact, ±30kV air
- EFT, IEC 61000-4-4, 40A (5/50ns)
- IEC 61000-4-5, 2nd Edition: 8/20 Surge, 8A Surge Immunity. SP12-01WTG-C-HV.
- Low clamping voltage
- Low leakage current
- Halogen free, Lead free and RoHS compliant

Applications

- LED Lighting Modules
- Portable Instrumentation
- General Purpose I/O
- Mobile & Handhelds
- RS232 / RS485
- CAN bus

Additional Information



Datasheet



Resources



Samples

Absolute Maximum Ratings

Symbol	Parameter	Value	Units
P_{pk}	Peak Pulse Power ($t_p=8/20\mu s$)	100	W
T_{OP}	Operating Temperature	-40 to 125	°C
T_{STOR}	Storage Temperature	-55 to 150	°C

Notes:

CAUTION: Stresses above those listed in "Absolute Maximum Ratings" may cause permanent damage to the component. This is a stress only rating and operation of the component at these or any other conditions above those indicated in the operational sections of this specification is not implied.

Thermal Information

Parameter	Rating	Units
Maximum Junction Temperature	150	°C
Maximum Lead Temperature (Soldering 20-40s)	260	°C

SP12-01WTG-C-HV Electrical Characteristics ($T_{OP}=25^\circ C$)

Parameter	Symbol	Test Conditions	Min	Typ	Max	Units
Reverse Standoff Voltage	V_{RWM}	$I_R \leq 1\mu A$, 1 pin to GND			12.0	V
Reverse Breakdown Voltage	V_{BR}	$I_R = 1mA$, 1 pin to GND	13.3			V
Leakage Current	I_{LEAK}	$V_R = 12V$, 1 pin to GND			0.1	μA
Clamp Voltage ¹	V_C	$I_{PP} = 1A$, $t_p = 8/20\mu s$, Fwd		16		V
		$I_{PP} = 8A$, $t_p = 8/20\mu s$, Fwd		19		V
Dynamic Resistance ²	R_{DYN}	TLP, $t_p = 100ns$, 1 pin to GND		0.4		Ω
Peak Pulse Current	I_{PP}	$t_p = 8/20\mu s$			8.0	A
ESD Withstand Voltage ¹	V_{ESD}	IEC61000-4-2 (Contact Discharge)	± 30			kV
		IEC61000-4-2 (Air Discharge)	± 30			kV
Diode Capacitance ¹	C_{D-GND}	Reverse Bias=0V, f=1MHz		26	30	pF

Note:

¹ Parameter is guaranteed by design and/or component characterization.

² Transmission Line Pulse (TLP) test setting : Std.TDR(50 Ω), $t_p=100ns$, $t_r=0.2ns$ ITLP and VTLP averaging window: start $t_1=70ns$ to end $t_2=80ns$

SP15-01WTG-C-HV Electrical Characteristics ($T_{OP}=25^\circ C$)

Parameter	Symbol	Test Conditions	Min	Typ	Max	Units
Reverse Standoff Voltage	V_{RWM}	$I_R \leq 1\mu A$, 1 pin to GND			15.0	V
Reverse Breakdown Voltage	V_{BR}	$I_R = 1mA$, 1 pin to GND	16.7			V
Leakage Current	I_{LEAK}	$V_R = 15V$, 1 pin to GND			0.1	μA
Clamp Voltage ¹	V_C	$I_{PP} = 1A$, $t_p = 8/20\mu s$, Fwd		21		V
		$I_{PP} = 5A$, $t_p = 8/20\mu s$, Fwd		27		V
Dynamic Resistance ²	R_{DYN}	TLP, $t_p = 100ns$, 1 pin to GND		0.43		Ω
Peak Pulse Current	I_{PP}	$t_p = 8/20\mu s$			5.0	A
ESD Withstand Voltage ¹	V_{ESD}	IEC61000-4-2 (Contact Discharge)	± 30			kV
		IEC61000-4-2 (Air Discharge)	± 30			kV
Diode Capacitance ¹	$C_{I/O-GND}$	Reverse Bias=0V, f=1MHz		21	24	pF

Note:

¹ Parameter is guaranteed by design and/or component characterization.

² Transmission Line Pulse (TLP) test setting : Std.TDR(50 Ω), $t_p=100ns$, $t_r=0.2ns$ ITLP and VTLP averaging window: start $t_1=70ns$ to end $t_2=80ns$

SP24-01WTG-C-HV Electrical Characteristics (T_{OP}=25°C)

Parameter	Symbol	Test Conditions	Min	Typ	Max	Units
Reverse Standoff Voltage	V _{RWM}	I _R ≤ 1μA, 1 pin to GND			24.0	V
Reverse Breakdown Voltage	V _{BR}	I _R = 1mA, 1 pin to GND	26.7			V
Leakage Current	I _{LEAK}	V _R = 24V, 1 pin to GND			0.1	μA
Clamp Voltage ¹	V _C	I _{PP} = 1A, t _p = 8/20μs, Fwd		32		V
		I _{PP} = 3.0A, t _p = 8/20μs, Fwd		40		V
Dynamic Resistance ²	R _{DYN}	TLP, t _p = 100ns, 1 pin to GND		0.7		Ω
Peak Pulse Current	I _{PP}	t _p = 8/20μs			3.0	A
ESD Withstand Voltage ¹	V _{ESD}	IEC61000-4-2 (Contact Discharge)	±18			kV
		IEC61000-4-2 (Air Discharge)	±24			kV
Diode Capacitance ¹	C _{I/O-GND}	Reverse Bias=0V, f=1MHz		13	17	pF

Note:

¹ Parameter is guaranteed by design and/or component characterization.

² Transmission Line Pulse (TLP) test setting : Std.TDR(50Ω),tp=100ns, tr=0.2ns ITLP and VTLP averaging window: start t1=70ns to end t2=80ns

SP36-01WTG-C-HV Electrical Characteristics (T_{OP}=25°C)

Parameter	Symbol	Test Conditions	Min	Typ	Max	Units
Reverse Standoff Voltage	V _{RWM}	I _R ≤ 1μA, 1 pin to GND			36.0	V
Reverse Breakdown Voltage	V _{BR}	I _R = 1mA, 1 pin to GND	40.0			V
Leakage Current	I _{LEAK}	V _R = 36V, 1 pin to GND			0.1	μA
Clamp Voltage ¹	V _C	I _{PP} = 1A, t _p = 8/20μs, Fwd		48		V
Dynamic Resistance ²	R _{DYN}	TLP, t _p = 100ns, 1 pin to GND		1.4		Ω
Peak Pulse Current	I _{PP}	t _p = 8/20μs			1.5	A
ESD Withstand Voltage ¹	V _{ESD}	IEC61000-4-2 (Contact Discharge)	±10			kV
		IEC61000-4-2 (Air Discharge)	±15			kV
Diode Capacitance ¹	C _{I/O-GND}	Reverse Bias=0V, f=1MHz		10	13	pF

Note:

¹ Parameter is guaranteed by design and/or component characterization.

² Transmission Line Pulse (TLP) test setting : Std.TDR(50Ω),tp=100ns, tr=0.2ns ITLP and VTLP averaging window: start t1=70ns to end t2=80ns

Power Derating Curve

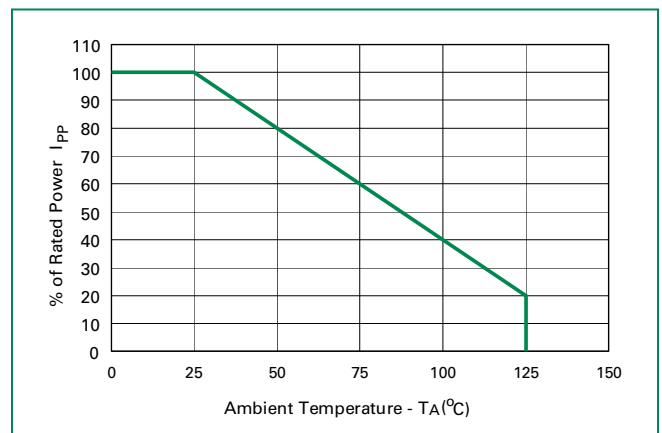

SP12-01WTG-C-HV Transmission Line Pulsing(TLP) Plot

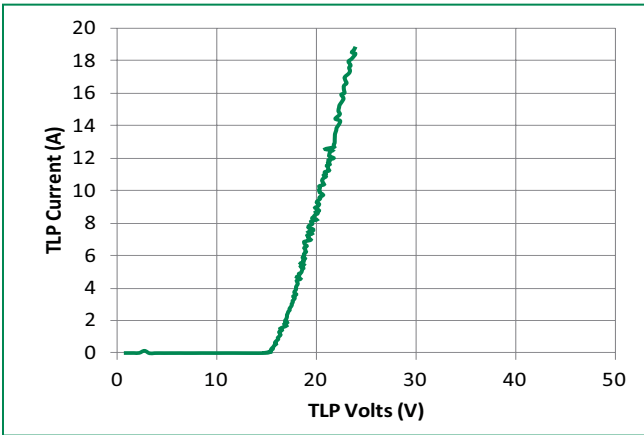

SP15-01WTG-C-HV Transmission Line Pulsing(TLP) Plot

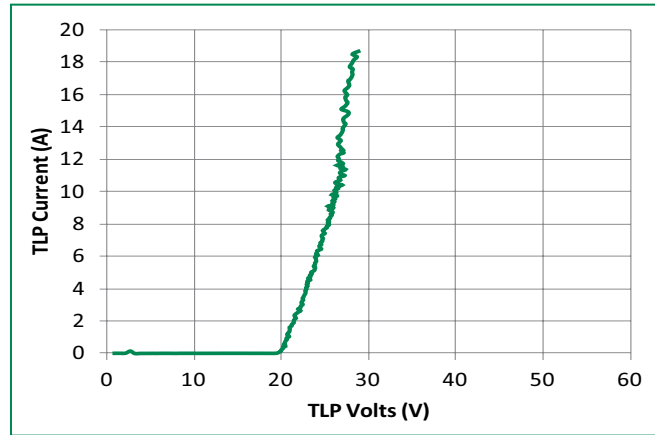

SP24-01WTG-C-HV Transmission Line Pulsing(TLP) Plot

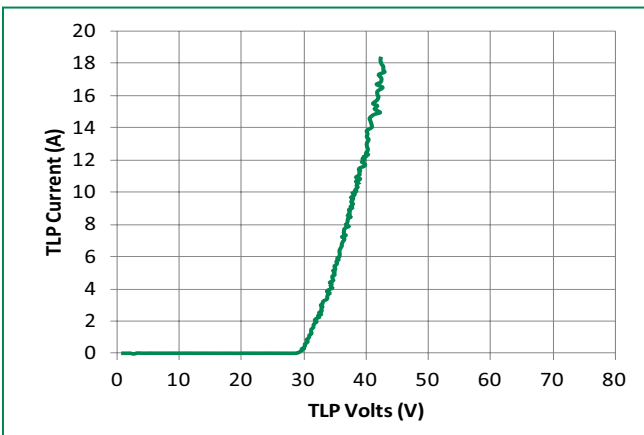

SP36-01WTG-C-HV Transmission Line Pulsing(TLP) Plot

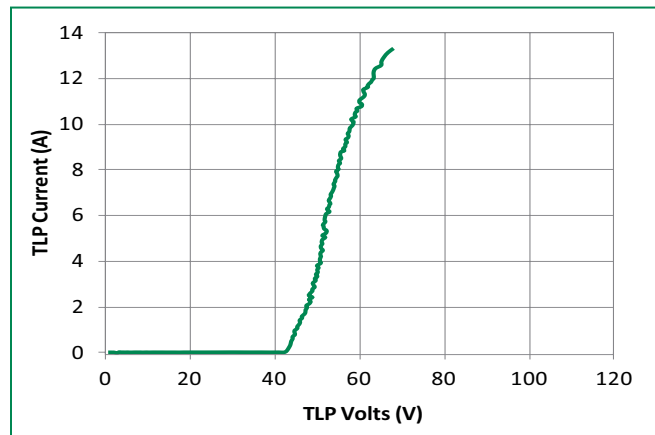

Pulse Waveform

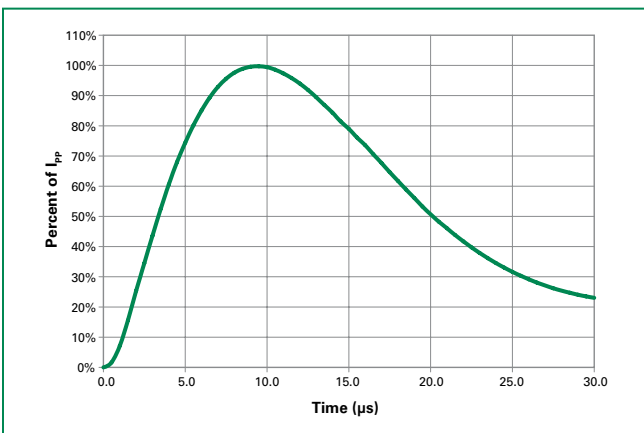

Soldering Parameters

Reflow Condition		Pb – Free assembly
Pre Heat	- Temperature Min ($T_{s(min)}$)	150°C
	- Temperature Max ($T_{s(max)}$)	200°C
	- Time (min to max) (t_s)	60 – 180 secs
Average ramp up rate (Liquidus) Temp (T_L) to peak		3°C/second max
$T_{s(max)}$ to T_L - Ramp-up Rate		3°C/second max
Reflow	- Temperature (T_L) (Liquidus)	217°C
	- Temperature (t_L)	60 – 150 seconds
Peak Temperature (T_p)		260 ^{+0/-5} °C
Time within 5°C of actual peak Temperature (t_p)		20 – 40 seconds
Ramp-down Rate		6°C/second max
Time 25°C to peak Temperature (T_p)		8 minutes Max.
Do not exceed		260°C

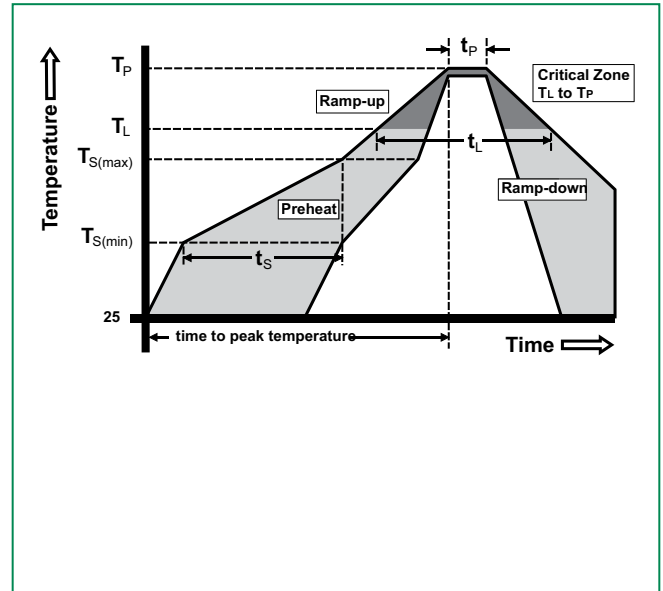

Product Characteristics

Lead Plating	Pre-Plated Frame
Lead Material	Copper Alloy
Lead Coplanarity	0.0004 inches (0.102mm)
Substitute Material	Silicon
Body Material	Molded Epoxy
Flammability	UL 94 V-0

- Notes :
1. All dimensions are in millimeters
 2. Dimensions include solder plating.
 3. Dimensions are exclusive of mold flash & metal burr.
 4. Blo is facing up for mold and facing down for trim/form, i.e. reverse trim/form.
 5. Package surface matte finish VDI 11-13.

Ordering Information

Part Number	Package	Marking	Min. Order Qty.
SP12-01WTG-C-HV	FLIPCHIP	2	10000
SP15-01WTG-C-HV	FLIPCHIP	5	10000
SP24-01WTG-C-HV	FLIPCHIP	4	10000
SP36-01WTG-C-HV	FLIPCHIP	6	10000

Part Marking System



- 2: SP12-01WTG-C-HV
- 5: SP15-01WTG-C-HV
- 4: SP24-01WTG-C-HV
- 6: SP36-01WTG-C-HV

Part Numbering System

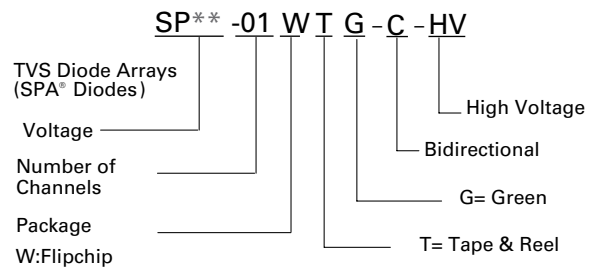

Package Dimensions – FLIPCHIP

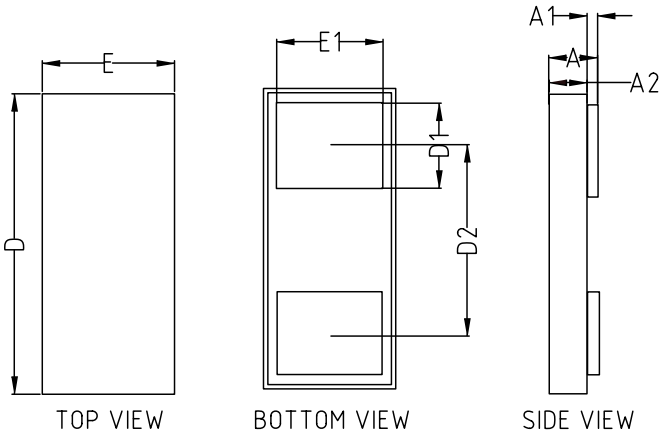

Symbol	Package	FLIPCHIP				
	JEDEC	MO-236				
	Millimeters			Inches		
	Min	Typ	Max	Min	Typ	Max
A	0.273	0.301	0.329	0.011	0.012	0.013
A1	0.008	0.011	0.014	0.000	0.000	0.001
A2	0.265	0.290	0.315	0.011	0.012	0.013
D	0.605	0.640	0.655	0.024	0.026	0.027
D1	0.145	0.15	0.155	0.006	0.006	0.006
D2	0.400 REF			0.016 REF		
E1	0.245	0.25	0.255	0.010	0.010	0.010
E	0.305	0.340	0.355	0.012	0.014	0.015

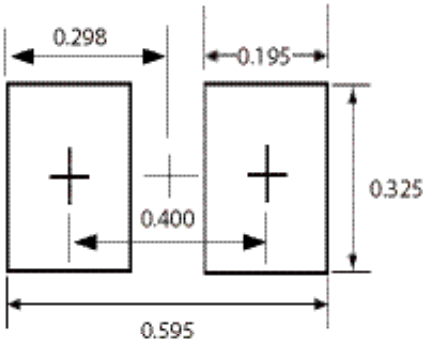

Recommended Soldering Pad Layout (mm)

Embossed Carrier Tape & Reel Specification – FLIPCHIP

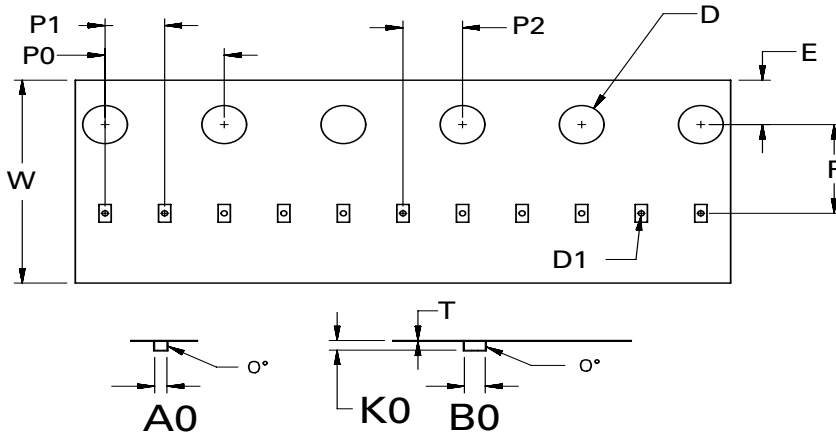

Symbol	Millimeters
A0	0.41+/-0.03
B0	0.70+/-0.03
D	∅ 1.50 + 0.10
D1	∅ 0.20 +/- 0.05
E	1.75+/-0.10
F	3.50+/-0.05
K0	0.38+/-0.03
P0	4.00+/-0.10
P1	2.00+/-0.05
P2	2.00+/-0.05
W	8.00 + 0.30/-0.10
T	0.23+/-0.02

单击下面可查看定价，库存，交付和生命周期等信息

[>>Littelfuse\(美国力特\)](#)