

Kxxx0yU SIDAC Series

RoHS

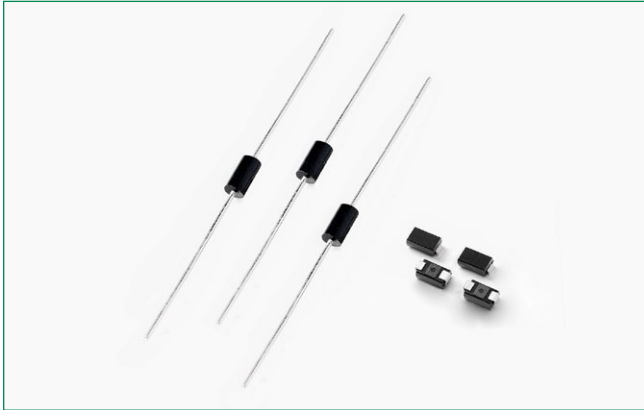

Description

The SIDAC is a silicon unilateral voltage triggered switch. Upon application of a voltage exceeding the SIDAC breakover voltage point, the SIDAC switches on through a negative resistance region to a low on-state voltage. Conduction continues until the current is interrupted or drops below the minimum holding current of the component.

SIDACs feature glass-passivated junctions to ensure a rugged and dependable component capable of withstanding harsh environments.

Features

- Rectified AC/DC Circuit Oriented
- RoHS Compliant
- Triggering Voltage of 75V to 260V

Applications

Suitable for capacitor-discharge HV generator circuit

Schematic Symbol

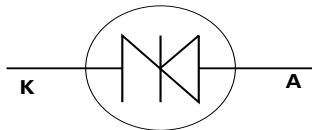

Electrical Specifications (T_J = 25°C, unless otherwise specified)

Symbol	Parameters	Test Conditions	min	max	Unit
V _{BO}	Breakover/Trigger Voltage	K0820yURP	75	90	V
		K0900yURP	79	97	
		K1050yURP	95	110	
		K1100yURP	104	118	
		K1200yURP	110	125	
		K1300yURP	120	138	
		K1400yURP	130	146	
		K1500yURP	142	157	
		K1800yURP	167	183	
		K2000yURP	190	210	
		K2200yURP	210	230	
		K2300yURP	220	240	
		V _{DRM}	Repetitive Peak Off-state Voltage	K0820yURP	
K0900yURP	70				
K1050yURP	90				
K1100yURP	90				
K1200yURP	100				
K1300yURP	110				
K1400yURP	115				
K1500yURP	120				
K1800yURP	150				
K2000yURP	170				
K2200yURP	190				
K2300yURP	200				
K2400yURP	210				
K2500yURP	220				

Electrical Specifications ($T_j = 25^\circ\text{C}$, unless otherwise specified)

Symbol	Parameters	Test Conditions	Min	Max	Unit	
$I_{T(RMS)}$	On-state RMS Current	50/60Hz		1	A	
I_{DRM}	Repetitive Peak Off-state Current	$V = V_{DRM}$ 50/60Hz Sine Wave		5	μA	
V_{TM}	Peak On-state Voltage	$I_T = 1\text{A}$		1.2	V	
I_H	Dynamic Holding Current	$R_L = 100\Omega$ 50/60Hz Sine Wave	10	80	mA	
R_S	Switching Resistance, $R_S = \frac{(V_{BO} - V_S)}{(I_S - I_{BO})}$	50/60Hz Sine Wave	100		Ω	
I_{BO}	Breakover Current	50/60Hz Sine Wave		10	μA	
I_{TRM}	Peak Repetitive Pulse Current (refer to figure 5 and figure 6)	K0820yU~ K0900yU	$T_P = 10\mu\text{s}$ $T_A = 125^\circ\text{C}$	60Hz	80	A
				5Hz	160	
		K1050yU~ K2000yU	$T_P = 10\mu\text{s}$ $T_A = 125^\circ\text{C}$	60Hz	120	
				5Hz	280	
		K2200yU~ K2500yU	$T_P = 10\mu\text{s}$ $T_A = 135^\circ\text{C}$	60Hz	120	
				5Hz	280	
I_{TSM}	Peak Non-repetitive Surge Current (refer to figure 4)	Single Cycle	60Hz	20	A	
			50Hz	16.7		
di/dt	Critical Rate of Rise of On-state Current			150	A/ μs	
dv/dt	Critical Rate of Rise of Off-state Voltage		1500		V/ μs	
T_S	Storage Temperature Range		-40	150	$^\circ\text{C}$	
T_J	Junction Temperature Range	K0820yU~K2000yU	-40	125	$^\circ\text{C}$	
		K2200yU~K2500yU	-40	150		
$R_{\theta JL}$	Thermal Resistance, Junction to Lead	DO-214		30	$^\circ\text{C/W}$	
		DO-15		18		

Figure 1: V-I Characteristics

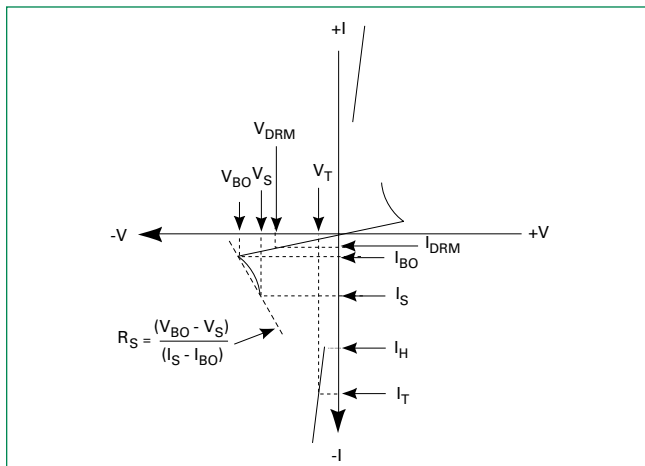

Figure 2: On-state Current vs. On-state Voltage (Typical)



Figure 3: Power Dissipation vs. On-state Current (Typical)

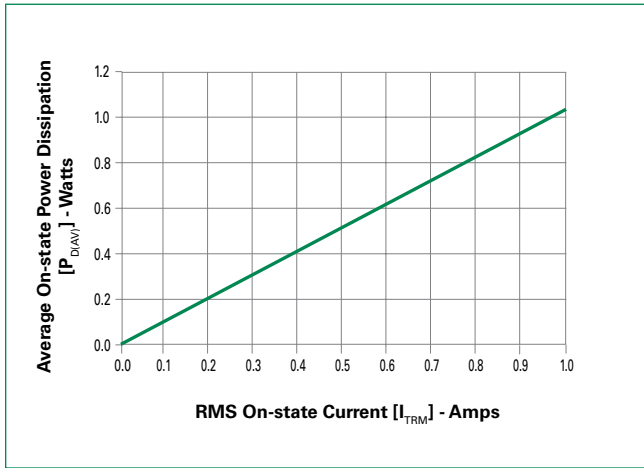

Figure 4: Peak Non-repetitive Surge Current (I_{TSM}) vs. Number of Cycles

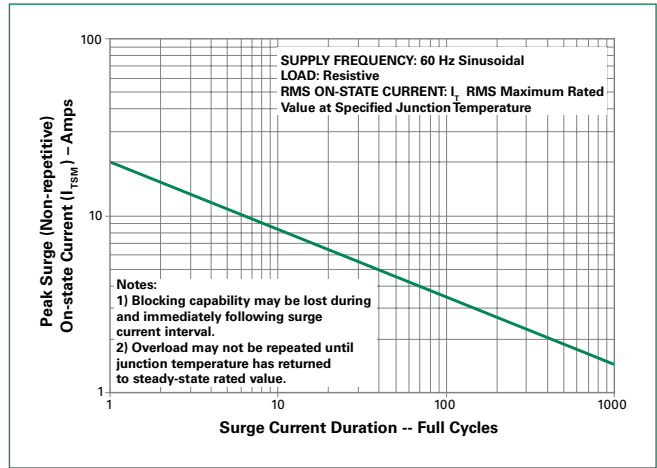

Figure 5: Repetitive Peak On-state Current (I_{TRM}) vs. Pulse Width at Various Frequencies of K0820yU/K0900yU

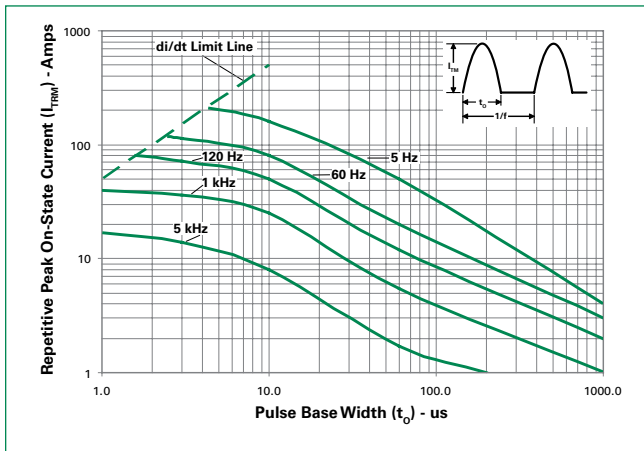

Figure 6: Repetitive Peak On-state Current (I_{TRM}) vs. Pulse Width at Various Frequencies of K1050yU~K2500yU

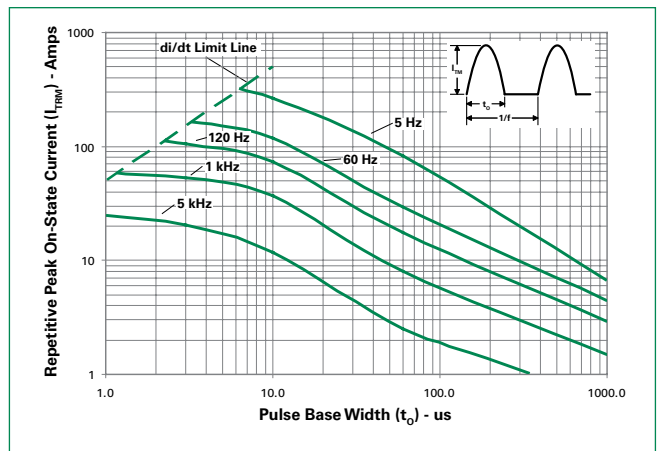

Figure 7: Normalized V_{BO} Change vs. Junction Temperature

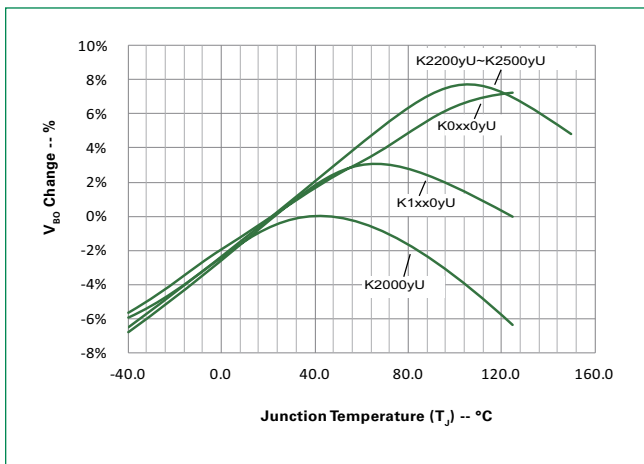

Figure 8: Normalized DC Holding Current vs. Junction Temperature

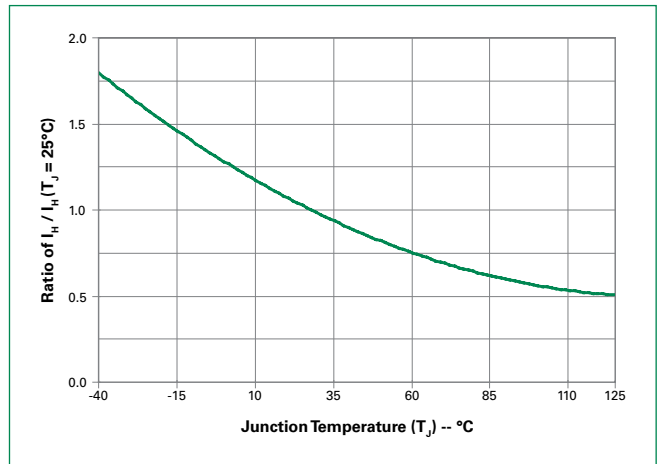

Figure 9: Maximum Allowable Case Temperature vs. RMS On-State Current

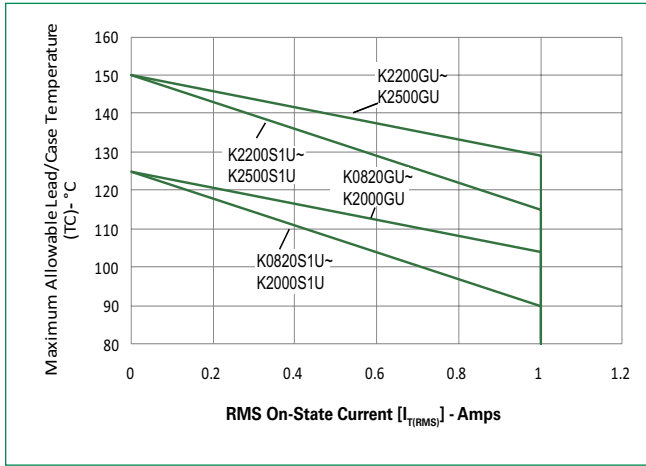

Figure 10: Maximum Allowable Ambient Temperature vs. RMS On-State Current

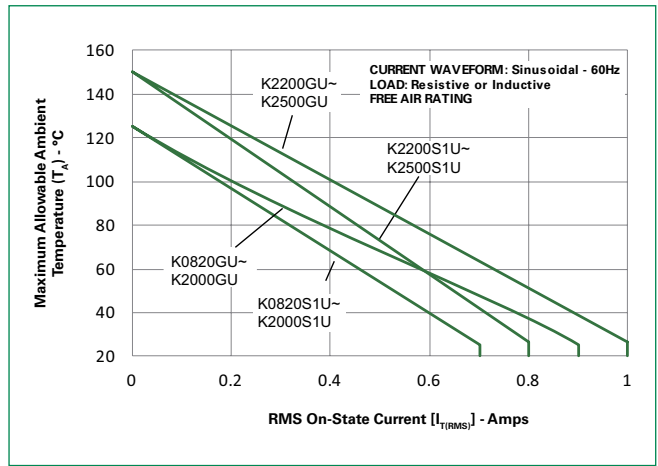

Figure 11: Normalized Repetitive Peak Breakover Current (I_{BO}) vs. Junction Temperature

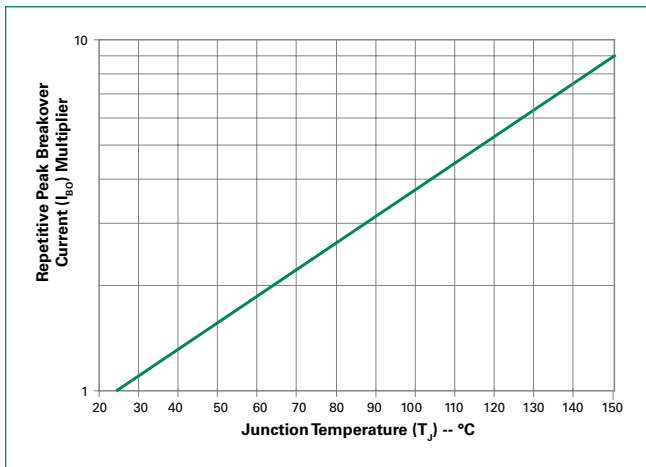

Figure 12: Dynamic Holding Current Test Circuit for SIDACs

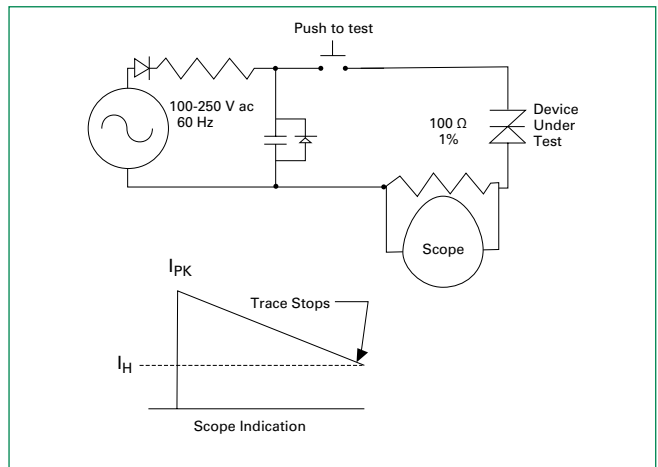

Figure 13: Basic SIDAC Circuit

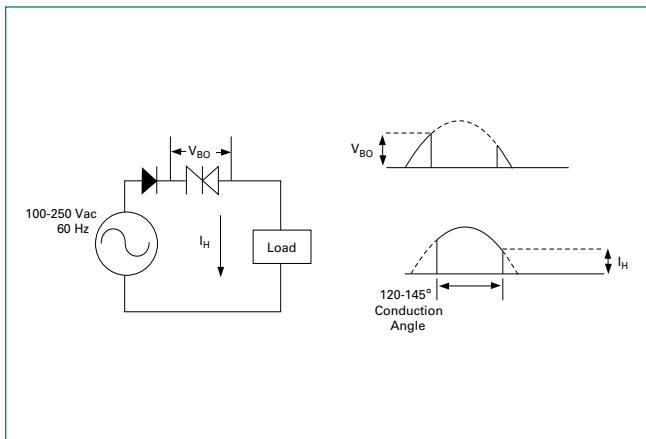
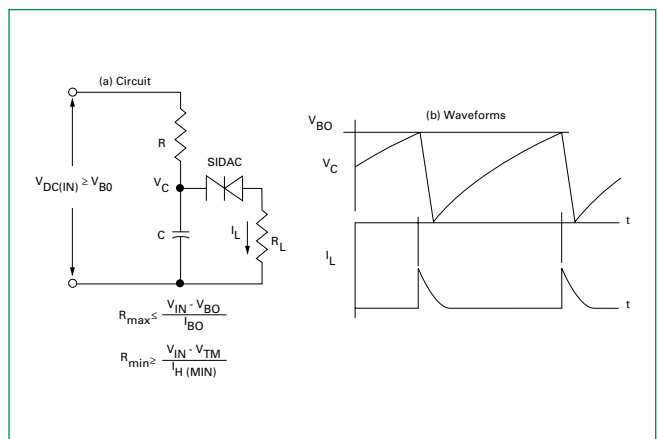
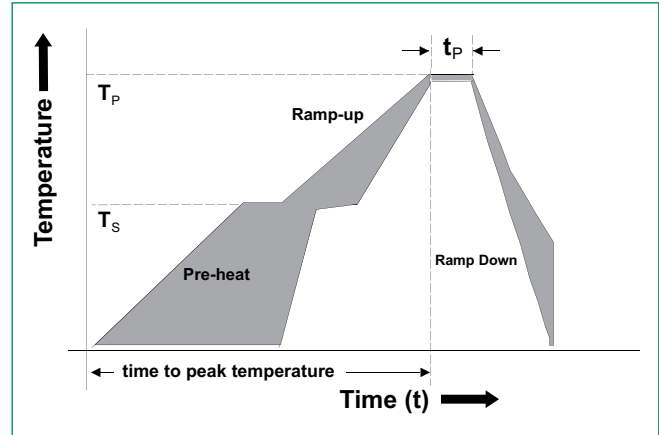

Figure 14: Relaxation Oscillator Using a SIDAC



Flow Soldering (Solder Dipping)

Wave soldering condition		Pb - Free assembly
Pre Heat	- Temperature Min	140°C
	- Temperature Max	160°C
	Time to Pre-Heat Temp	60-150 seconds
Average ramp up rate to Pre-Heat Temp		5°C/second max
Peak Temperature		260+0/-5 °C
Average ramp up rate (T_{pre-heat} to T_p)		5°C/second max
Time within actual peak Temperature Max		6 seconds
Ramp-down Rate		5°C/second max



Physical Specifications

Terminal Finish	100% Matte Tin Plated
Body Material	UL Recognized compound meeting flammability rating V-0
Lead Material	Copper Alloy

Design Considerations

Careful selection of the correct component for the application's operating parameters and environment will go a long way toward extending the operating life of the Thyristor. Overheating and surge currents are the main killers of SIDACs. Correct mounting, soldering, and forming of the leads also help protect against component damage.

Reliability/Environmental Tests

Test	Specifications and Conditions
High Temperature Voltage Blocking	MIL-STD-750: Method 1040, Condition A Rated V_{DRM} (Rectified VAC-peak), $T_{j,r}$, 504 hours
Temperature Cycling	MIL-STD-750: Method 1051 -40°C to 150°C, 15-minute dwell, 100 cycles
Biased Temperature & Humidity	EIA/JEDEC: JESD22-A101 80% min V_{BO} (V_{DC}), 85°C, 85%RH, 1008 hours
High Temp Storage	MIL-STD-750: Method 1031 150°C, 1008 hours
Low-Temp Storage	-40°C, 1008 hours
Thermal Shock	MIL-STD-750: Method 1056 0°C to 100°C, 5-minute dwell, 10-second transfer, 10 cycles
Resistance to Solder Heat	MIL-STD-750: Method 2031 260°C, 10 seconds
Solderability	ANSI/J-STD-002: Category 3
Lead Bend	MIL-STD-750: Method 2036, Condition E

Dimensions

DO-214AC (SMA)

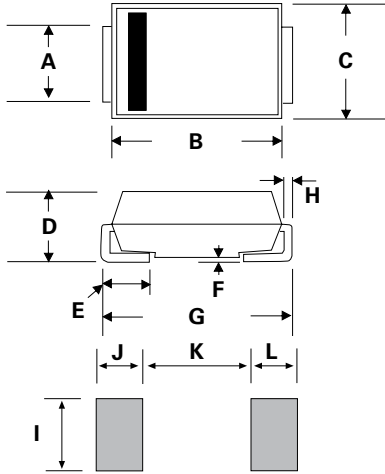

Dimensions	Inches		Millimeters	
	Min	Max	Min	Max
A	0.049	0.065	1.250	1.650
B	0.157	0.177	3.990	4.500
C	0.100	0.110	2.540	2.790
D	0.078	0.090	1.980	2.290
E	0.030	0.060	0.780	1.520
F	-	0.008	-	0.203
G	0.194	0.208	4.930	5.280
H	0.006	0.012	0.152	0.305
I	0.070	-	1.800	-
J	0.082	-	2.100	-
K	-	0.090	-	2.300
L	0.082	-	2.100	-

Dimensions — DO-15

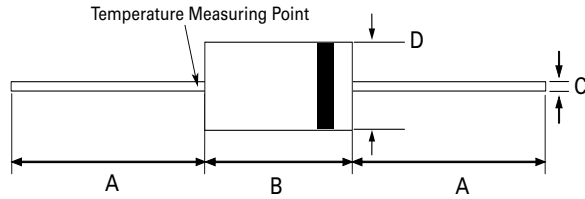

Dimension	Inches		Millimeters	
	Max	Max	Min	Max
A	1.000	-	25.40	-
B	0.230	0.300	5.80	7.60
C	0.028	0.034	0.71	0.86
D	0.104	0.140	2.60	3.60

Product Selector

Part Number	Switching Voltage Range		Blocking Voltage V_{DRM}	Packages	
	V_{BO} Minimum	V_{BO} Maximum		DO-15	DO-214
K0820yURP	75	90	70	K0820GURP	K0820S1URP
K0900yURP	79	97	70	K0900GURP	K0900S1URP
K1050yURP	95	110	90	K1050GURP	K1050S1URP
K1100yURP	104	118	90	K1100GURP	K1100S1URP
K1200yURP	110	125	100	K1200GURP	K1200S1URP
K1300yURP	120	138	110	K1300GURP	K1300S1URP
K1400yURP	130	146	115	K1400GURP	K1400S1URP
K1500yURP	142	157	120	K1500GURP	K1500S1URP
K1800yURP	167	183	150	K1800GURP	K1800S1URP
K2000yURP	190	210	170	K2000GURP	K2000S1URP
K2200yURP	210	230	190	K2200GURP	K2200S1URP
K2300yURP	220	240	200	K2300GURP	K2300S1URP
K2400yURP	230	250	210	K2400GURP	K2400S1URP
K2500yURP	240	260	220	K2500GURP	K2500S1URP

Packing Options

Part Number	Marking	Weight	Package Mode	Packages	Base Quantity
Kxxx0S1URP	Kxxx	0.062g	Reel Pack	DO-214AC	5000
Kxxx0GURP	Kxxx	0.38g	Reel Pack	DO-15	5000

Part Numbering System

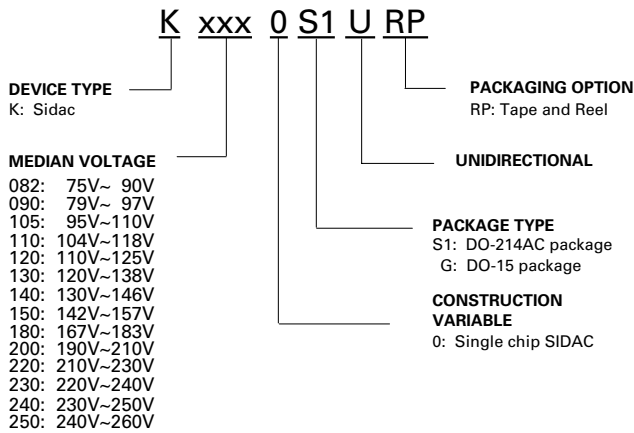

Part Marking System

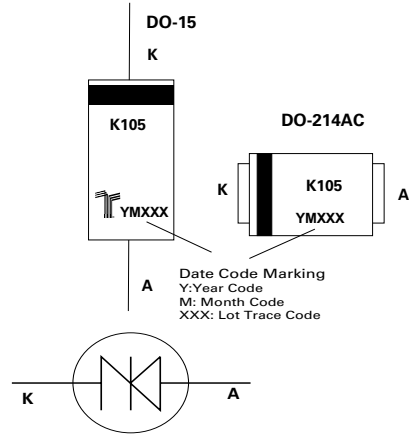

Tape and Reel Specification – DO-214AC

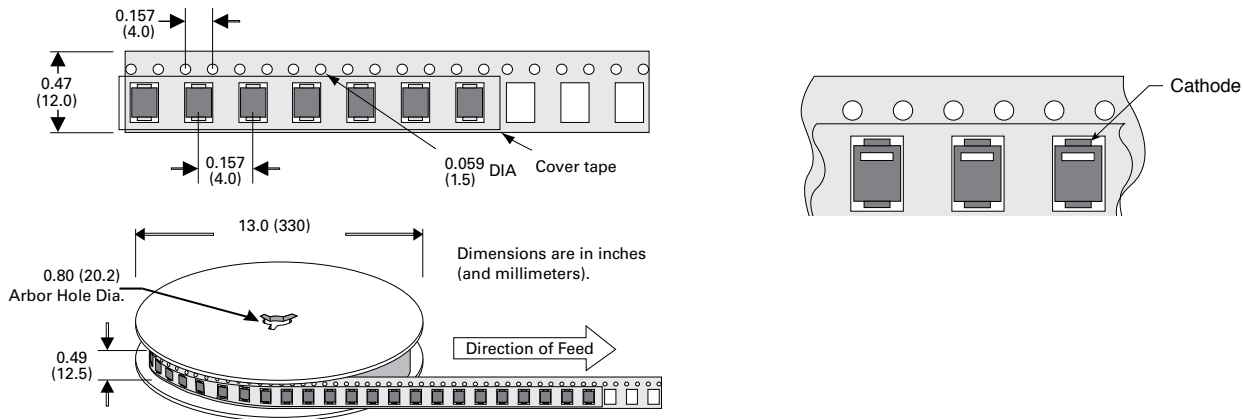

DO-15 Reel Pack (RP) Specifications

Meets all EIA RS-296 Standards

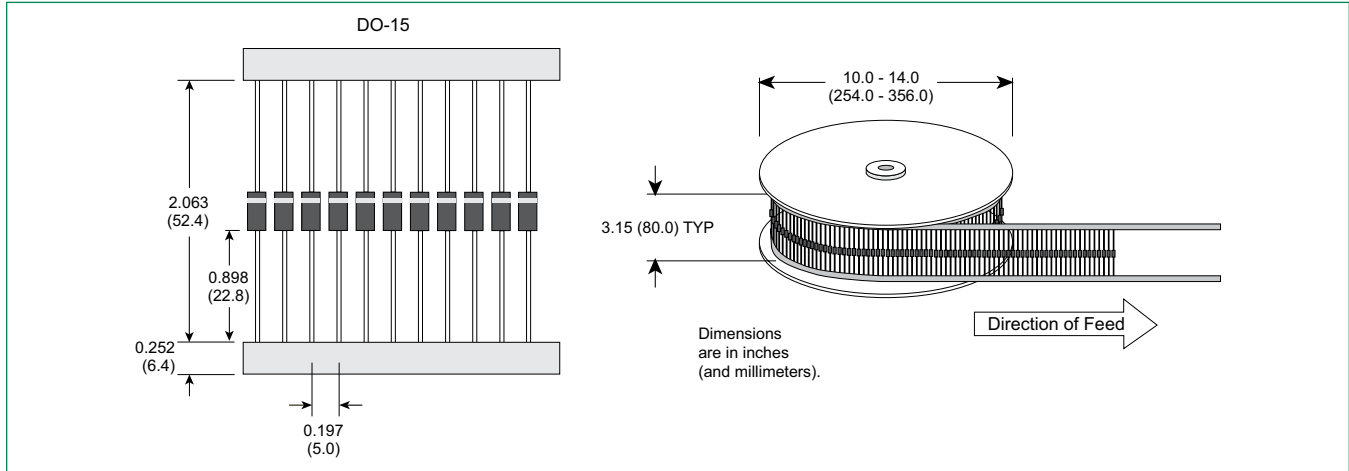

单击下面可查看定价，库存，交付和生命周期等信息

[>>Littelfuse\(美国力特\)](#)