

DURB2020CT

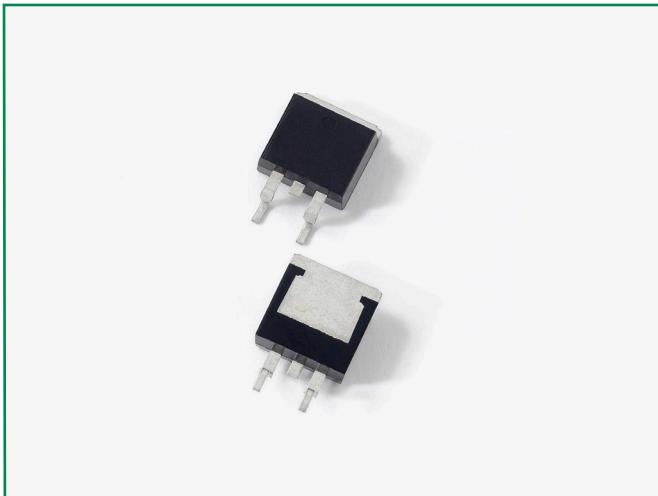

Description

Littelfuse DUR series Ultrafast Recovery Rectifier is designed to meet the general requirements of commercial applications by providing low T_{rr} , high-temperature, low-leakage and low forward voltage drop products. It is suitable for output rectifier, free-wheeling or boost diode in high-frequency power switching application such as switch mode power supply and DC-DC converters.

Features

- Ultra-fast switching
- Low reverse leakage current
- High surge current capability
- Low forward voltage drop
- Common cathode configuration in surface mount TO-263 (D²PAK) package
- Pb-free E3 means 2nd level interconnect is Pb-free and the terminal finish material is tin(Sn) (IPC/JEDEC J-STD-609A.01)

Circuit Diagram

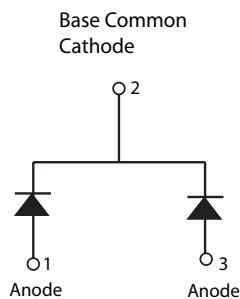

Applications

- Output rectifiers in switch mode power supplies (SMPS) and DC to DC converters
- Free-wheeling diode or boost diode in converters and motor control circuits
- Anti-parallel diode for high frequency switching devices such as IGBT
- Uninterruptible Power Supplies (UPS)
- Inductive heating and melting
- Ultrasonic cleaners and welders

Maximum Ratings

Characteristics	Symbol	Conditions	Max.	Unit
Peak Inverse Voltage	V_{RWM}	-	200	V
Average Rectified Forward Current	$I_{F(AV)}$	50% duty cycle @ $T_c = 100^\circ\text{C}$, rectangular wave form	10 (Per Leg)	A
			20 (Total Device)	
Peak One Cycle Non-Repetitive Surge Current (per leg)	I_{FSM}	8.3 ms, half sine pulse	125	A

Electrical Characteristics

Characteristics	Symbol	Conditions	Max.	Unit
Forward Voltage Drop (Per Leg) ¹	V_F	@ $I_F = 10\text{A}$, Pulse, $T_J = 25^\circ\text{C}$	1.15	V
Reverse Current	I_{R1}	@ $V_R = \text{Rated } V_R$, $T_J = 25^\circ\text{C}$	15	μA
	I_{R2}	@ $V_R = \text{Rated } V_R$, $T_J = 125^\circ\text{C}$	250	μA
Junction Capacitance	C_T	Bias=5V, 10KHZ	60	pF
Reverse Recovery Time	t_{rr1}	$I_F = 500\text{mA}$, $I_R = 1\text{A}$, and $I_{rm} = 250\text{mA}$	35	ns

Footnote 1: Pulse Width < 300 μs , Duty Cycle < 2%

Thermal-Mechanical Specifications

Characteristics	Symbol	Conditions	Specification	Unit
Junction Temperature	T_J	-	-55 to +150	°C
Storage Temperature	T_{stg}	-	-55 to +150	°C
Typical Thermal Resistance Junction to Case	$R_{\theta JC}$	DC operation	3.5	°C/W
Typical Thermal Resistance Junction to Ambient	$R_{\theta JA}$	DC operation	50	°C/W
Approximate Weight	wt	-	1.41	g
Case Style	-	D ² PAK	-	-

Figure 1: Typical Forward Characteristics

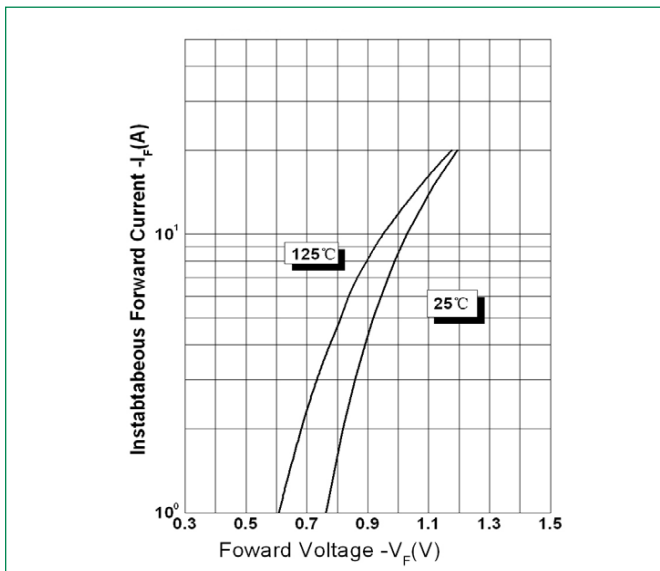

Figure 2: Typical Reverse Characteristics

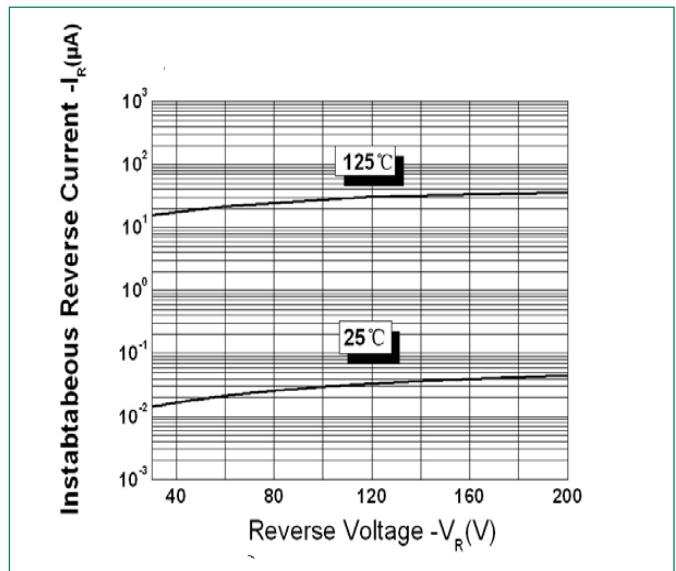
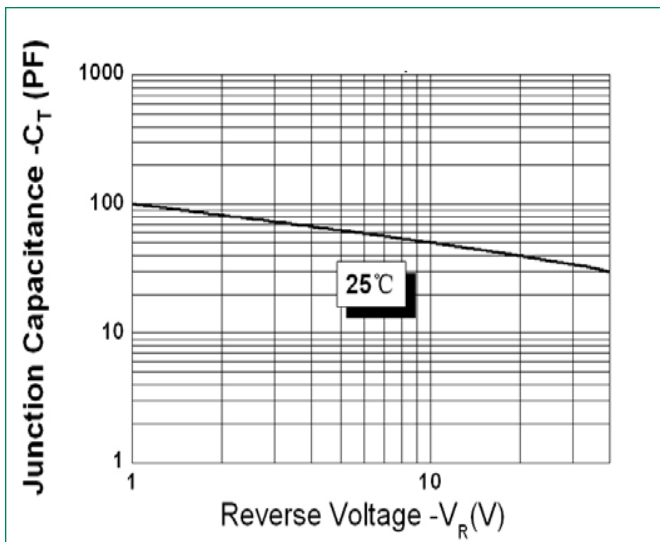
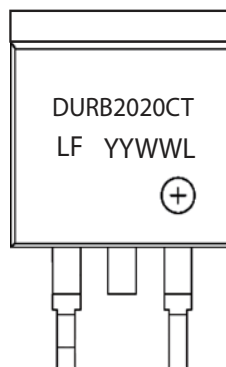

Figure 3: Typical Junction Capacitance



Part Numbering and Marking System



- DUR = Device Type
- B = Package type
- 20 = Forward Current (20A)
- 20 = Reverse Voltage (200V)
- CT = Configuration
- LF = Littelfuse
- YY = Year
- WW = Week
- L = Lot Number

Ultrafast Recovery Rectifier

DURB2020CT, 2x 10A, 200V, TO-263, Common Cathode

Packing Options

Part Number	Marking	Packing Mode	M.O.Q
DURB2020CT	DURB2020CT	800pcs / reel	800

Dimensions-Package TO-263 (D²PAK)

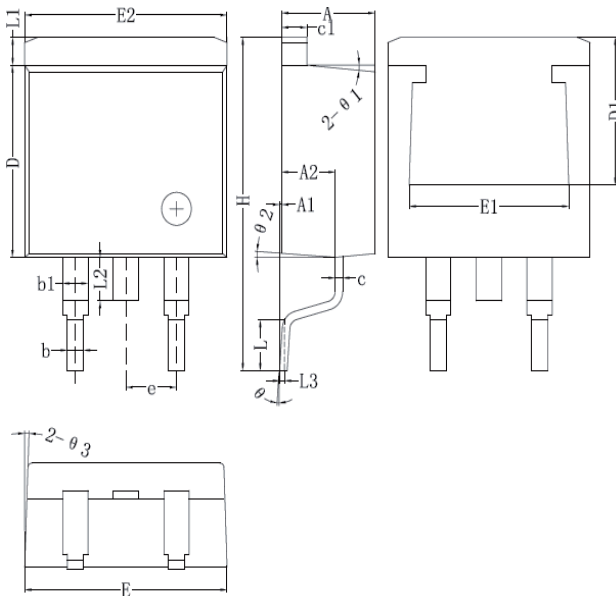

	Millimeters	
	Min	Max
A	4.06	4.83
A1	0.00	0.25
b	0.51	0.99
b1	1.14	1.78
c	0.31*	0.74
c1	1.14	1.65
D	8.38	9.65
D1	6.40*	-
E	9.65	10.67
E1	6.22	-
E2	9.65	10.67
e	2.54 BSC	
H	14.60*	15.88
L	1.78	2.79
L1	-	1.68
L2	-	1.78
L3	0.254 BSC	

Footnote *: The spec. does not comply with JEDEC spec.

Carrier Tape & Reel Specification TO-263 (D²PAK)

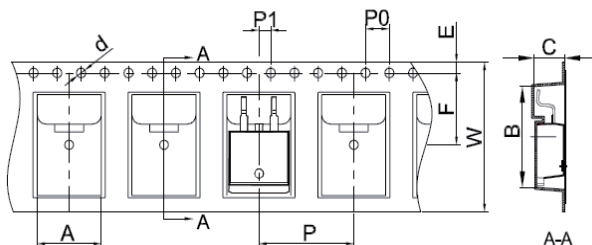

	Millimeters	
	Min	Max
A	10.70	10.90
B	16.03	16.23
C	5.11	5.31
d	ø1.45	ø1.65
E	1.65	1.85
F	11.40	11.60
P0	3.90	4.10
p	15.90	16.10
P1	1.90	2.10
W	23.90	24.30

单击下面可查看定价，库存，交付和生命周期等信息

[>>Littelfuse\(美国力特\)](#)