

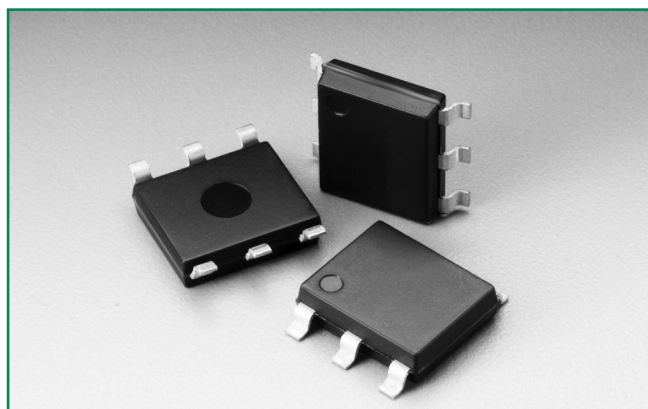

SIDACtor® Balanced Series - MS-013



Agency Approvals

Agency	Agency File Number
	E133083

Pinout Designation

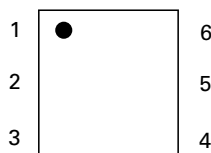

Schematic Symbol

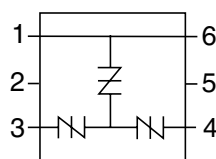

Description

The SIDACtor® Balanced Series MS-013 are designed to protect baseband equipment from overvoltage transients. The patented “Y” configuration ensures balanced overvoltage protection that prevents a longitudinal to differential conversion.

The series provides a single port surface mount solution that enables voice through DS-1 equipment to comply with various global regulatory standards.

Features and Benefits

- Balanced overvoltage protection
- Low voltage overshoot
- Low on-state voltage
- Does not degrade surge capability after multiple surge events within limit.
- Fails short circuit when surged in excess of ratings
- Replaces three discrete components
- Meets UL/IEC 60950-1 creepage and clearance
- RoHS Compliant and Lead-Free
- 2nd level interconnect is Pb-free per IPC/JEDEC J-STD-609A.01

Applicable Global Standards

- TIA-968-A
- TIA-968-B
- ITU K.20/21/45 Enhanced Level
- ITU K.20/21/45 Basic Level
- GR 1089 Intra-building
- IEC 61000-4-5 2nd edition
- YD/T 1082
- YD/T 993
- YD/T 950
- GR 1089 Inter-building

Electrical Characteristics

Part Number	Part Marking	V_{DRM} @ $I_{DRM}=5\mu A$		V_S @ $100V/\mu s$		V_T	I_S	I_T	I_H	Capacitance
		V min	V max	V min	V max					
		Pins 1 & 6-3, 1 & 6-4		Pins 3-4						
P1553UALxx	P1553UA	130	180	130	180	8	800	2.2	150	See Capacitance Values table
P1803UALxx	P1803UA	150	210	150	210	8	800	2.2	150	
P2103UALxx	P2103UA	170	250	170	250	8	800	2.2	150	
P2353UALxx	P2353UA	200	270	200	270	8	800	2.2	150	
P2703UALxx	P2703UA	230	300	230	300	8	800	2.2	150	
P3203UALxx	P3203UA	270	350	270	350	8	800	2.2	150	
P3403UALxx	P3403UA	300	400	300	400	8	800	2.2	150	
P5103UALxx	P5103UA	420	600	420	600	8	800	2.2	150	

Notes:

- Absolute maximum ratings measured at $T_A = +25^\circ C$ (unless otherwise noted).
- Components are bi-directional.
- **XX** = Part Number Suffix: 'TP' (Tube Pack) or 'RP' (Reel Pack).

Table continues on next page.

Electrical Characteristics (continued)

Part Number	Part Marking	V_{DRM} @ $I_{DRM}=5\mu A$	V_S @ 100V/ μs	V_{DRM} @ $I_{DRM}=5\mu A$	V_S @ 100V/ μs	V_T	I_S	I_T	I_H	Capacitance
		V min	V max	V min	V max	V max	mA max	A max	mA min	
		Pins 1 & 6-3, 1 & 6-4		Pins 3-4						
P1553UBLxx	P1553UB	130	180	130	180	8	800	2.2	150	See Capacitance Values table
P1803UBLxx	P1803UB	150	210	150	210	8	800	2.2	150	
P2103UBLxx	P2103UB	170	250	170	250	8	800	2.2	150	
P2353UBLxx	P2353UB	200	270	200	270	8	800	2.2	150	
P2703UBLxx	P2703UB	230	300	230	300	8	800	2.2	150	
P3203UBLxx	P3203UB	270	350	270	350	8	800	2.2	150	
P3403UBLxx	P3403UB	300	400	300	400	8	800	2.2	150	
P5103UBLxx	P5103UB	420	600	420	600	8	800	2.2	150	
P1553UCLxx	P1553UC	130	180	130	180	8	800	2.2	150	
P1803UCLxx	P1803UC	150	210	150	210	8	800	2.2	150	
P2103UCLxx	P2103UC	170	250	170	250	8	800	2.2	150	
P2353UCLxx	P2353UC	200	270	200	270	8	800	2.2	150	
P2703UCLxx	P2703UC	230	300	230	300	8	800	2.2	150	
P3203UCLxx	P3203UC	270	350	270	350	8	800	2.2	150	
P3403UCLxx	P3403UC	300	400	300	400	8	800	2.2	150	
P5103UCLxx	P5103UC	420	600	420	600	8	800	2.2	150	

Capacitance Values

Part Number	Pin 3-4 Tip-Ring		Pins 1 & 6-3, 1 & 6-4 Tip-Ground, Ring-Ground	
	pF min	pF max	pF min	pF max
P1553UALxx	20	95	10	60
P1803UALxx	20	85	10	55
P2103UALxx	15	85	10	55
P2353UALxx	15	75	10	50
P2703UALxx	15	75	10	50
P3203UALxx	15	70	10	45
P3403UALxx	15	65	10	45
P5103UALxx	10	60	10	40
P1553UBLxx	25	95	15	60
P1803UBLxx	25	85	15	55
P2103UBLxx	20	85	15	55
P2353UBLxx	20	75	15	50
P2703UBLxx	20	75	10	50
P3203UBLxx	20	70	10	45
P3403UBLxx	15	65	10	45
P5103UBLxx	15	60	10	40
P1553UCLxx	30	95	20	60
P1803UCLxx	30	85	15	55
P2103UCLxx	30	85	15	55
P2353UCLxx	25	75	15	50
P2703UCLxx	25	75	15	50
P3203UCLxx	25	70	15	45
P3403UCLxx	20	65	15	45
P5103UCLxx	20	60	10	40

Note: Off-state capacitance (C_o) is measured at 1 MHz with a 2 V bias.

Additional Information



Datasheet



Resources



Samples

Surge Ratings

Series	I_{PP}									I_{TSM} 50/60 Hz	di/dt
	0.2/310 ¹ 0.5/700 ²	2/10 ¹ 2/10 ²	8/20 ¹ 1.2/50 ²	10/160 ¹ 10/160 ²	10/560 ¹ 10/560 ²	5/320 ¹ 9/720 ²	10/360 ¹ 10/360 ²	10/1000 ¹ 10/1000 ²	5/310 ¹ 10/700 ²		
	A min	A min	A min	A min	A min	A min	A min	A min	A min		
A	20	150	150	90	50	75	75	45	75	20	500
B	25	250	250	150	100	100	125	80	100	25	500
C	50	500	400	200	150	200	175	100	200	50	500

Notes:
 1 Current waveform in μs
 2 Voltage waveform in μs
 - Peak pulse current rating (I_{PP}) is repetitive and guaranteed for the life of the product that remains in thermal equilibrium.
 - I_{PP} ratings applicable over temperature range of -40 to $+85^\circ C$
 - The component must initially be in thermal equilibrium with $-40^\circ C \leq T_J \leq +150^\circ C$

Thermal Considerations

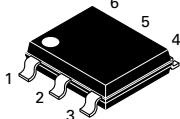
Package	Symbol	Parameter	Value	Unit
Modified MS-013 	T_J	Operating Junction Temperature Range	-40 to +150	$^\circ C$
	T_S	Storage Temperature Range	-65 to +150	$^\circ C$
	$R_{\theta JA}$	Thermal Resistance: Junction to Ambient	60	$^\circ C/W$

V-I Characteristics

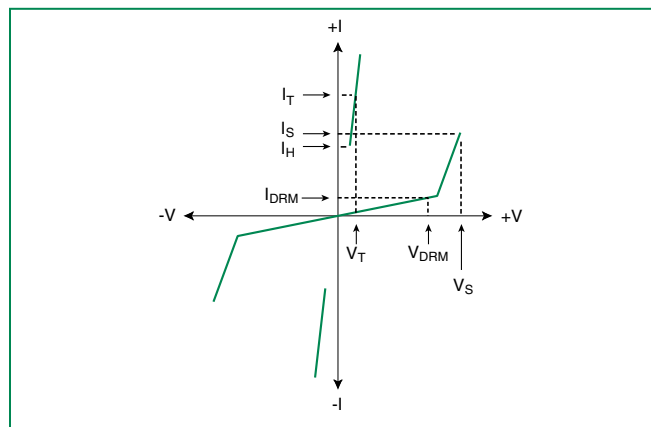

$t_r \times t_d$ Pulse Waveform

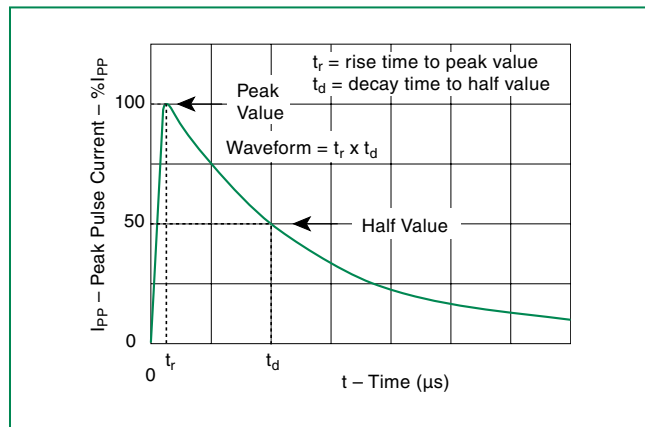

Normalized V_S Change vs. Junction Temperature

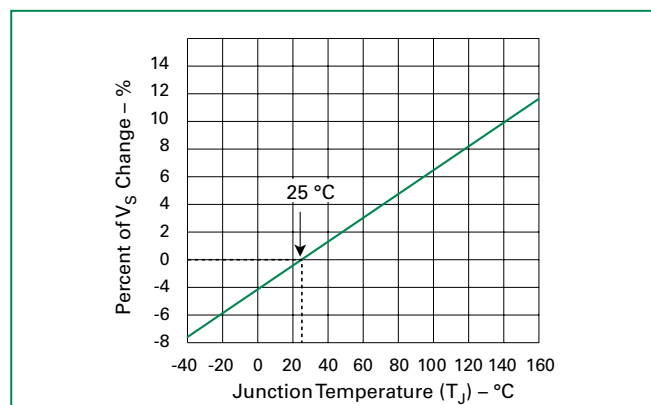

Normalized DC Holding Current vs. Case Temperature

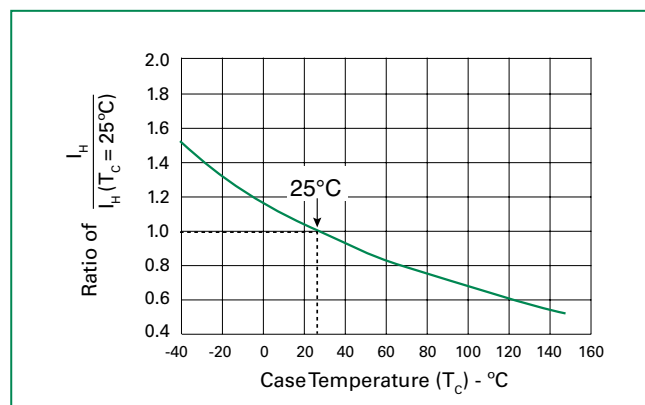

Soldering Parameters

Reflow Condition	Pb-Free assembly (see Fig. 1)	
Pre Heat	-Temperature Min ($T_{s(min)}$)	+150°C
	-Temperature Max ($T_{s(max)}$)	+200°C
	-Time (Min to Max) (t_s)	60-180 secs.
Average ramp up rate (Liquidus Temp (T_L) to peak)	3°C/sec. Max.	
$T_{s(max)}$ to T_L - Ramp-up Rate	3°C/sec. Max.	
Reflow	-Temperature (T_L) (Liquidus)	+217°C
	-Temperature (t_L)	60-150 secs.
Peak Temp (T_p)	+260(+0/-5)°C	
Time within 5°C of actual PeakTemp (t_p)	30 secs. Max.	
Ramp-down Rate	6°C/sec. Max.	
Time 25°C to Peak Temp (T_p)	8 min. Max.	
Do not exceed	+260°C	

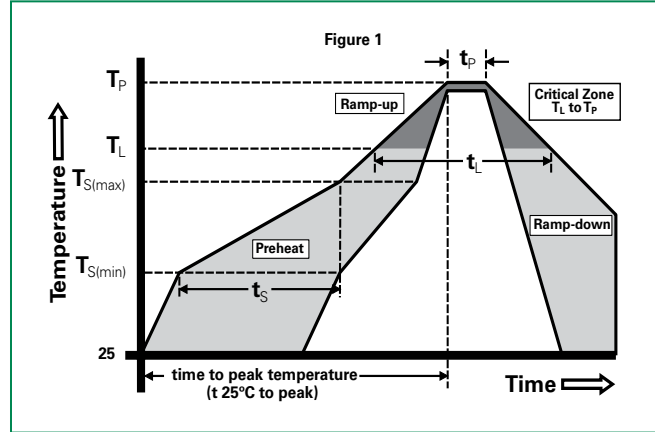

Physical Specifications

Lead Material	Copper Alloy
Terminal Finish	100% Matte-Tin Plated
Body Material	UL Recognized epoxy meeting flammability classification V-0

Environmental Specifications

High Temp Voltage Blocking	80% Rated V_{DRM} ($V_{AC Peak}$) +125°C or +150°C, 504 or 1008 hrs. MIL-STD-750 (Method 1040) JEDEC, JESD22-A-101
Temp Cycling	-65°C to +150°C, 15 min. dwell, 10 up to 100 cycles. MIL-STD-750 (Method 1051) EIA/JEDEC, JESD22-A104
Biased Temp & Humidity	52 V_{DC} (+85°C) 85%RH, 504 up to 1008 hrs. EIA/JEDEC, JESD22-A-101
High Temp Storage	+150°C 1008 hrs. MIL-STD-750 (Method 1031) JEDEC, JESD22-A-101
Low Temp Storage	-65°C, 1008 hrs.
Thermal Shock	0°C to +100°C, 5 min. dwell, 10 sec. transfer, 10 cycles. MIL-STD-750 (Method 1056) JEDEC, JESD22-A-106
Autoclave (Pressure Cooker Test)	+121°C, 100%RH, 2atm, 24 up to 168 hrs. EIA/JEDEC, JESD22-A-102
Resistance to Solder Heat	+260°C, 30 secs. MIL-STD-750 (Method 2031)
Moisture Sensitivity Level	85%RH, +85°C, 168 hrs., 3 reflow cycles (+260°C Peak). JEDEC-J-STD-020, Level 1

Part Marking

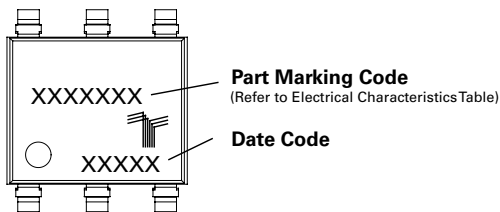

Part Numbering

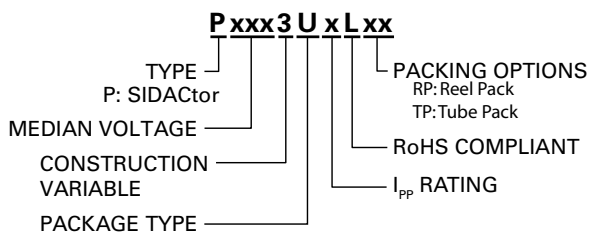

Packing Options

Package Type	Description	Quantity	Added Suffix	Industry Standard
U	Modified MS-013 6-pin Tape and Reel Pack	1500	RP	EIA-481-D
	Modified MS-013 6-pin Tube Pack	500 (50 per tube)	TP	N/A

Dimensions — MS-013

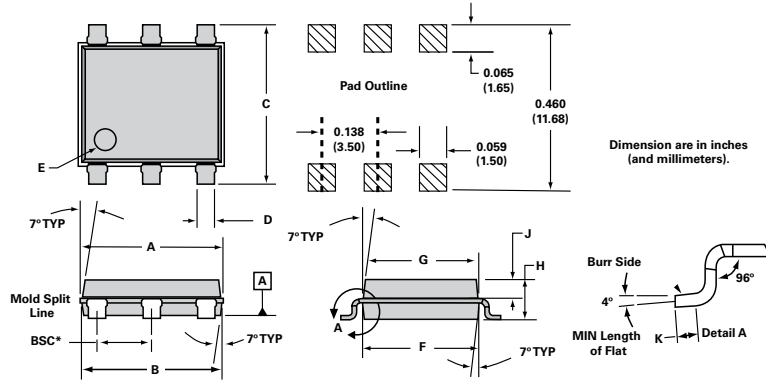

Dimensions	Inches		Millimeters	
	Min	Max	Min	Max
A	0.360	0.364	9.14	9.25
B	0.352	0.356	8.94	9.04
C	0.400	0.412	10.16	10.46
D	0.043	0.045	1.09	1.13
E	0.047	0.055	1.19	1.40
F	0.293	0.297	7.44	7.54
G	0.289	0.293	7.34	7.44
H	0.089	0.093	2.26	2.36
J	0.041	0.049	1.04	1.24
K	0.020		0.51	
BSC*	0.133	0.143	3.38	3.63

* BSC = Basic Spacing between Centers

Tape and Reel Specification — MS-013

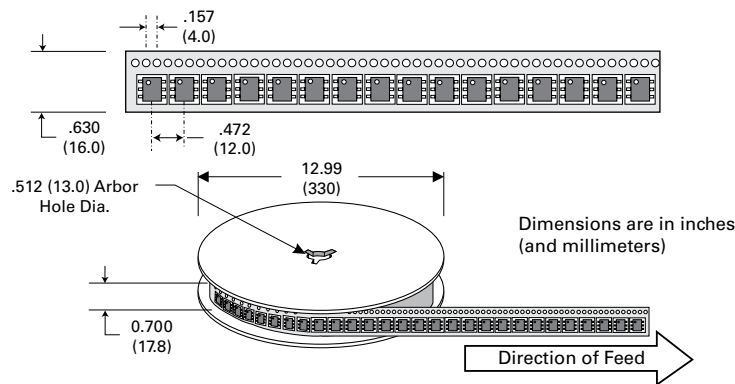

Tube Pack Specification — MS-013

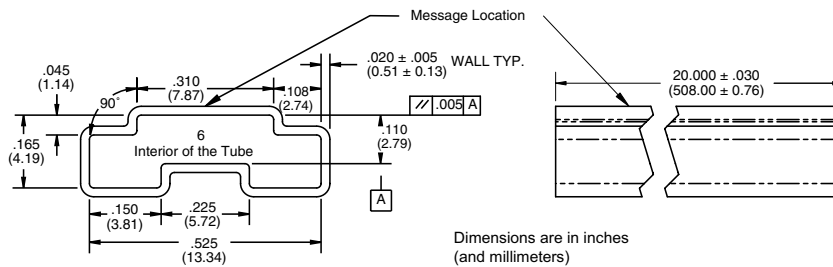

Disclaimer Notice - Information furnished is believed to be accurate and reliable. However, users should independently evaluate the suitability of and test each product selected for their own applications. Littelfuse products are not designed for, and may not be used in, all applications. Read complete Disclaimer Notice at www.littelfuse.com/disclaimer-electronics.

单击下面可查看定价，库存，交付和生命周期等信息

[>>Littelfuse\(美国力特\)](#)