

# SMDJ-HR Series

## Surface Mount – 3000W



### Additional Information



Resources



Accessories



Samples

### Agency Approvals

Agency	Agency File Number
	E230531

### Maximum Ratings and Thermal Characteristics

( $T_A = 25^\circ\text{C}$  unless otherwise noted)

Parameter	Symbol	Value	Unit
Peak Pulse Power Dissipation by 10/1000 $\mu\text{s}$ waveform (Note 1), (Note 2)	$P_{PPM}$	3000	W
Power Dissipation on infinite heat sink at $T_L = 50^\circ\text{C}$	$P_D$	6.5	W
Peak Forward Surge Current, 8.3ms Single Half Sine Wave (Note 3)	$I_{FSM}$	300	A
Maximum Instantaneous Forward Voltage at 100A for Unidirectional only	$V_F$	3.5	V
Operating Junction and Storage Temperature Range	$T_J, T_{STG}$	-65 to 150	$^\circ\text{C}$
Typical Thermal Resistance Junction to Lead	$R_{\theta JL}$	15	$^\circ\text{C}/\text{W}$
Typical Thermal Resistance Junction to Ambient	$R_{\theta JA}$	75	$^\circ\text{C}/\text{W}$

#### Notes:

1. Non-repetitive current pulse per Fig. 2 and derated above  $T_A = 25^\circ\text{C}$  per Fig. 3.
2. Mounted on copper pad area of 0.31x0.31" (8.0 x 8.0mm) to each terminal.
3. Measured on 8.3ms single half sine wave or equivalent square wave for unidirectional component only, duty cycle=4 per minute maximum.

### Description

The SMDJ-HR High Reliability series is designed specifically to protect sensitive electronic equipment from voltage transients induced by lightning and other transient voltage events.

### Features

- 3000W peak pulse power capability at 10/1000 $\mu\text{s}$  waveform, repetition rate (duty cycles):0.01%
- For surface mounted applications in order to optimize board space
- Low profile package
- Built-in strain relief
- $V_{BR} @ T_J = V_{BR} @ 25^\circ\text{C} \times (1 + \alpha T \times (T_J - 25))$  ( $\alpha$ : Temperature Coefficient, typical value is 0.1%)
- Glass passivated chip junction
- Fast response time: typically less than 1.0ps from 0V to VBR min
- Excellent clamping capability
- Low incremental surge resistance
- Typical  $I_R \leq 2\mu\text{A}$  for  $V_R > 10\text{V}$
- Meet MSL level1, per J-STD-020, LF maximum peak of 260 $^\circ\text{C}$
- UL Recognized compound meeting flammability rating V-0.
- Matte tin lead-free plated
- Halogen free and RoHS compliant
- Pb-free E3 means 2nd level interconnect is Pb-free and the terminal finish material is tin(Sn) (IPC/JEDEC J-STD-609A.01)

### Applications

TVS components are ideal for the protection of I/O Interfaces, VCC bus and other vulnerable circuits used in Telecom, Computer, Industrial and Consumer electronic applications.

### Functional Diagram

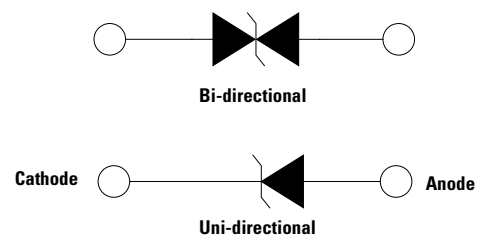

# SMDJ-HR Series

## Surface Mount – 3000W

### Electrical Characteristics

Part Number (Uni)	Part Number (Bi)	Marking		Reverse Stand off Voltage $V_R$ (Volts)	Breakdown Voltage $V_{BR}$ (Volts) @ $I_T$		Test Current $I_T$ (mA)	Maximum Clamping Voltage $V_C$ @ $I_{PP}$ (V)	Maximum Peak Pulse Current $I_{PP}$ (A)	Maximum Reverse Leakage $I_R$ @ $V_R$ ( $\mu$ A)	Agency Approval 
		Uni	Bi		Min	Max					
SMDJ5.0A-HR	SMDJ5.0CA-HR	RDE	DDE	5.0	6.40	7.00	10	9.2	326.1	800	X
SMDJ6.0A-HR	SMDJ6.0CA-HR	RDG	DDG	6.0	6.67	7.37	10	10.3	291.3	800	X
SMDJ6.5A-HR	SMDJ6.5CA-HR	RDK	DDK	6.5	7.22	7.98	10	11.2	267.9	500	X
SMDJ7.0A-HR	SMDJ7.0CA-HR	PDM	DDM	7.0	7.78	8.60	10	12.0	250.0	200	X
SMDJ7.5A-HR	SMDJ7.5CA-HR	PDP	DDP	7.5	8.33	9.21	1	12.9	232.6	100	X
SMDJ8.0A-HR	SMDJ8.0CA-HR	PDR	DDR	8.0	8.89	9.83	1	13.6	220.6	50	X
SMDJ8.5A-HR	SMDJ8.5CA-HR	PDT	DDT	8.5	9.44	10.40	1	14.4	208.3	20	X
SMDJ9.0A-HR	SMDJ9.0CA-HR	PDV	DDV	9.0	10.00	11.10	1	15.4	194.8	10	X
SMDJ10A-HR	SMDJ10CA-HR	PDX	DDX	10.0	11.10	12.30	1	17.0	176.5	5	X
SMDJ11A-HR	SMDJ11CA-HR	PDZ	DDZ	11.0	12.20	13.50	1	18.2	164.8	2	X
SMDJ12A-HR	SMDJ12CA-HR	PEE	DEE	12.0	13.30	14.70	1	19.9	150.8	2	X
SMDJ13A-HR	SMDJ13CA-HR	PEG	DEG	13.0	14.40	15.90	1	21.5	139.5	2	X
SMDJ14A-HR	SMDJ14CA-HR	PEK	DEK	14.0	15.60	17.20	1	23.2	129.3	2	X
SMDJ15A-HR	SMDJ15CA-HR	PEM	DEM	15.0	16.70	18.50	1	24.4	123.0	2	X
SMDJ16A-HR	SMDJ16CA-HR	PEP	DEP	16.0	17.80	19.70	1	26.0	115.4	2	X
SMDJ17A-HR	SMDJ17CA-HR	PER	DER	17.0	18.90	20.90	1	27.6	108.7	2	X
SMDJ18A-HR	SMDJ18CA-HR	PET	DET	18.0	20.00	22.10	1	29.2	102.7	2	X
SMDJ20A-HR	SMDJ20CA-HR	PEV	DEV	20.0	22.20	24.50	1	32.4	92.6	2	X
SMDJ22A-HR	SMDJ22CA-HR	PEX	DEX	22.0	24.40	26.90	1	35.5	84.5	2	X
SMDJ24A-HR	SMDJ24CA-HR	PEZ	DEZ	24.0	26.70	29.50	1	38.9	77.1	2	X
SMDJ26A-HR	SMDJ26CA-HR	PFE	DFE	26.0	28.90	31.90	1	42.1	71.3	2	X
SMDJ28A-HR	SMDJ28CA-HR	PFG	DFG	28.0	31.10	34.40	1	45.4	66.1	2	X
SMDJ30A-HR	SMDJ30CA-HR	PFK	DFK	30.0	33.30	36.80	1	48.4	62.0	2	X
SMDJ33A-HR	SMDJ33CA-HR	PFM	DFM	33.0	36.70	40.60	1	53.3	56.3	2	X
SMDJ36A-HR	SMDJ36CA-HR	PFP	DFP	36.0	40.00	44.20	1	58.1	51.6	2	X
SMDJ40A-HR	SMDJ40CA-HR	PFR	DFR	40.0	44.40	49.10	1	64.5	46.5	2	X
SMDJ43A-HR	SMDJ43CA-HR	PFT	DFT	43.0	47.80	52.80	1	69.4	43.2	2	X
SMDJ45A-HR	SMDJ45CA-HR	PFV	DFV	45.0	50.00	55.30	1	72.7	41.3	2	X
SMDJ48A-HR	SMDJ48CA-HR	PFX	DFX	48.0	53.30	58.90	1	77.4	38.8	2	X
SMDJ51A-HR	SMDJ51CA-HR	PFZ	DFZ	51.0	56.70	62.70	1	82.4	36.4	2	X
SMDJ54A-HR	SMDJ54CA-HR	RGE	DGE	54.0	60.00	66.30	1	87.1	34.4	2	X
SMDJ58A-HR	SMDJ58CA-HR	PGG	DGG	58.0	64.40	71.20	1	93.6	32.1	2	X
SMDJ60A-HR	SMDJ60CA-HR	PGK	DGK	60.0	66.70	73.70	1	96.8	31.0	2	X
SMDJ64A-HR	SMDJ64CA-HR	PGM	DGM	64.0	71.10	78.60	1	103.0	29.1	2	X
SMDJ70A-HR	SMDJ70CA-HR	PGP	DGP	70.0	77.80	86.00	1	113.0	26.5	2	X
SMDJ75A-HR	SMDJ75CA-HR	PGR	DGR	75.0	83.30	92.10	1	121.0	24.8	2	X
SMDJ78A-HR	SMDJ78CA-HR	PGT	DGT	78.0	86.70	95.80	1	126.0	23.8	2	X
SMDJ85A-HR	SMDJ85CA-HR	PGV	DGV	85.0	94.40	104.00	1	137.0	21.9	2	X
SMDJ90A-HR	SMDJ90CA-HR	PGX	DGX	90.0	100.00	111.00	1	146.0	20.5	2	X
SMDJ100A-HR	SMDJ100CA-HR	PGZ	DGZ	100.0	111.00	123.00	1	162.0	18.5	2	X
SMDJ110A-HR	SMDJ110CA-HR	PHE	DHE	110.0	122.00	135.00	1	177.0	16.9	2	X
SMDJ120A-HR	SMDJ120CA-HR	PHG	DHG	120.0	133.00	147.00	1	193.0	15.5	2	X
SMDJ130A-HR	SMDJ130CA-HR	PHK	DHK	130.0	144.00	159.00	1	209.0	14.4	2	X
SMDJ150A-HR	SMDJ150CA-HR	PHM	DHM	150.0	167.00	185.00	1	243.0	12.3	2	X
SMDJ170A-HR	SMDJ170CA-HR	PHR	DHR	170.0	189.00	209.00	1	275.0	10.9	2	X

**Note:**

1. Each lot of parts will pass group B test requirements.

# SMDJ-HR Series

## Surface Mount – 3000W

### Screen Process

100% Vision Inspection	MIL-STD-750 method 2074
100% High Temperature Storage Life (168hrs, 175°C)	MIL-STD-750 method 1031
100% X-RAY inspection	MIL-STD-750 method 2076
100% Temperature Cycle Test (-55 to 150°C, 20 cycles, dwell time 15 min)	MIL-STD-750 method 1051
100% Reflow (2X)	JEDEC J-STD-020
100% Surge Test (2x)	MIL-STD-750 method 4066
100% HTRB 150°C Bias=VR(80% breakdown voltage, 96hrs, and each direction 96hrs for Bi-directional products)	MIL-STD-750 method 1038
Final Electrical Test( 100% 3 sigma limit, 100% dynamic test and PAT limit)	MIL-STD-750 method 4016.4021.4011

Note: Up-screen program can be specified by customer's request via contacting Littelfuse service

### Group B Test Requirements

Screen	Method	Condition	Requirement
Surge test	10/1000 $\mu$ s Peak Pulse Waveform	Maximum clamping Voltage ( $V_C$ ) @ Peak Pulse Current ( $I_{PP}$ )	Sample Size 45 perform 10x Accept 0 failures
Burn - In (HTRB)	MIL -STD-750, Method 1038.5	Applied voltage 100% $V_R$ @150°C	Sample size 45 340 hours (680 hours for bi-direction products, each direction 340 hours) Accept 0 failures
Electrical test	--	$I_R$ @ $V_R$ , $V_{(BR)}$ @ $I_T$	Sample size 45 Accept 0 failures

### I-V Curve Characteristics

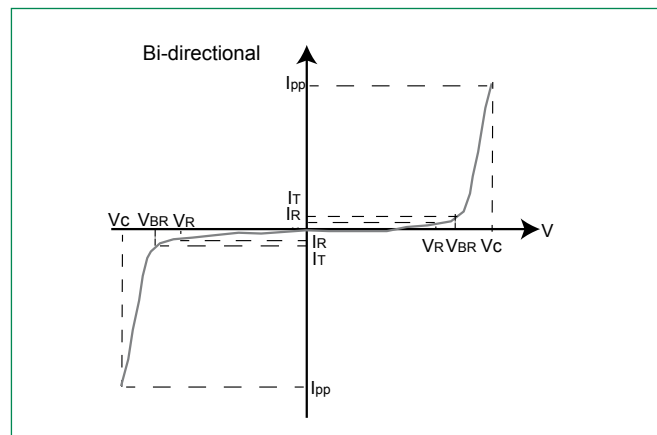
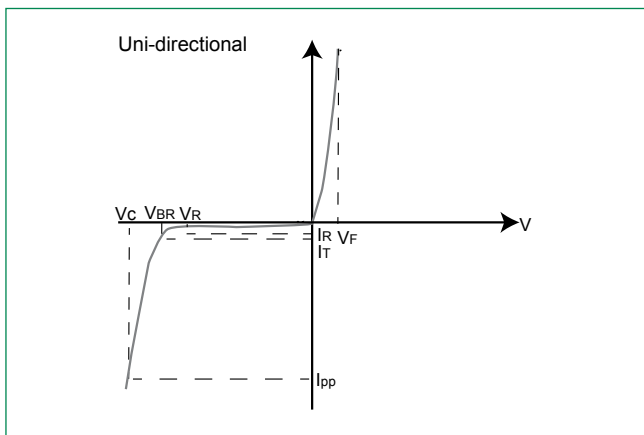

- $P_{PPM}$  Peak Pulse Power Dissipation** -- Max power dissipation  
 **$V_R$  Stand-off Voltage** -- Maximum voltage that can be applied to the TVS without operation  
 **$V_{BR}$  Breakdown Voltage** -- Maximum voltage that flows through the TVS at a specified test current ( $I_T$ )  
 **$V_C$  Clamping Voltage** -- Peak voltage measured across the suppressor at a specified  $I_{PPM}$  (peak impulse current)  
 **$I_R$  Reverse Leakage Current** -- Current measured at  $V_R$   
 **$V_F$  Forward Voltage Drop for Uni-directional**

# SMDJ-HR Series

## Surface Mount – 3000W

### Ratings and Characteristic Curves ( $T_A=25^\circ\text{C}$ unless otherwise noted)

**Figure 1 -**  
TVS Transients Clamping Waveform

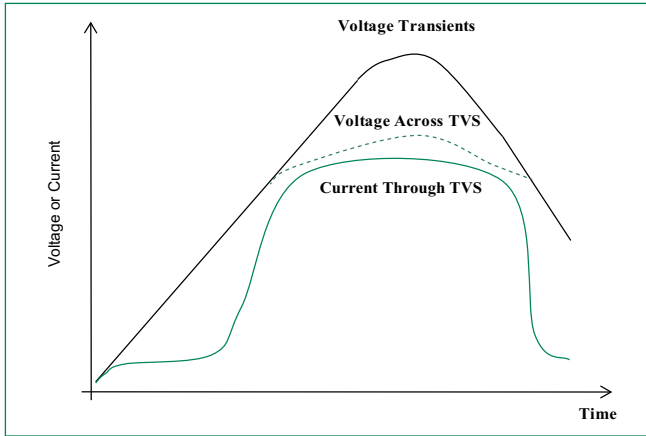

**Figure 2 -**  
Peak Pulse Power Rating

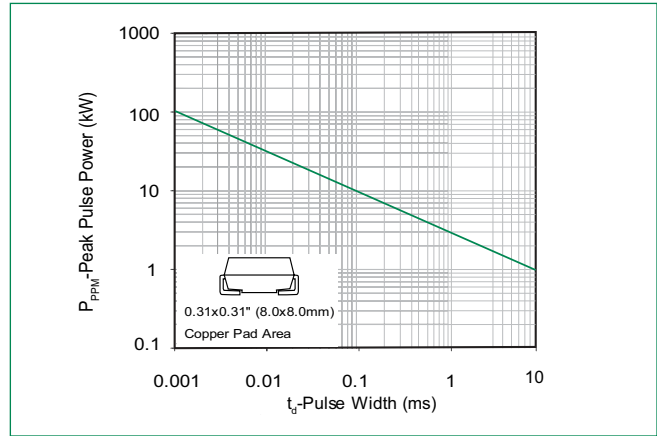

**Figure 3 -**  
Pulse Derating Curve

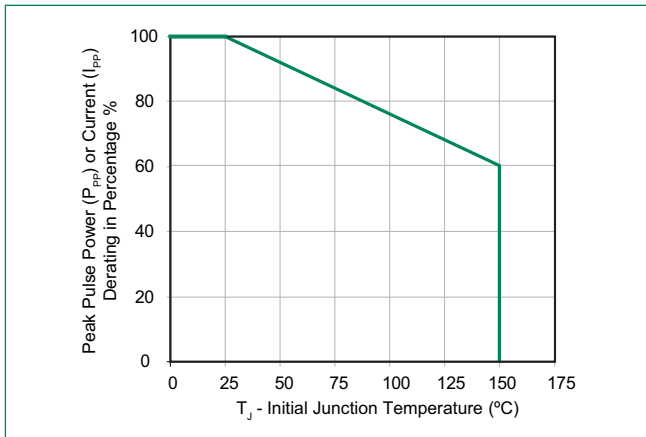

**Figure 4 -**  
Pulse Waveform

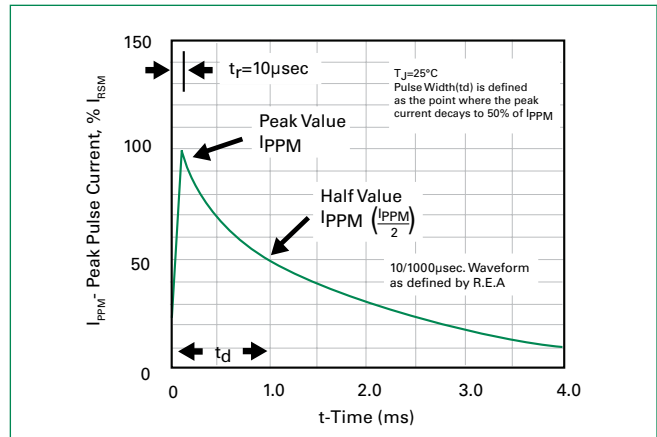

**Figure 5 -**  
Typical Junction Capacitance

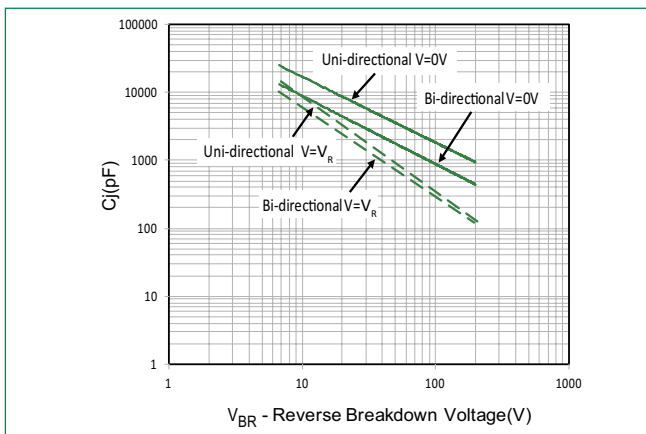

**Figure 6 -**  
Steady State Power Derating Curve

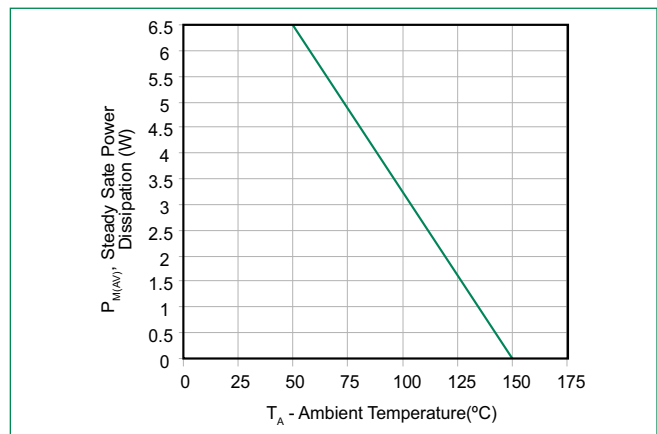

# SMDJ-HR Series

## Surface Mount – 3000W

**Figure 7 -**  
Maximum Non-Repetitive Peak Forward Surge Current  
Uni-Directional only

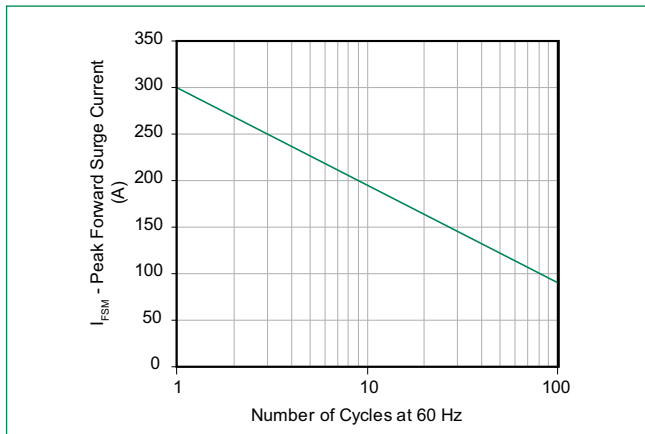

## Soldering Parameters

<b>Reflow Condition</b>	Lead-free assembly	
<b>Pre Heat</b>	- Temperature Min ( $T_{s(min)}$ )	150°C
	- Temperature Max ( $T_{s(max)}$ )	200°C
	- Time (min to max) ( $t_s$ )	60 – 180 secs
<b>Average ramp up rate (Liquidus Temp (<math>T_L</math>) to peak)</b>		3°C/second max
<b><math>T_{s(max)}</math> to <math>T_L</math> - Ramp-up Rate</b>		3°C/second max
<b>Reflow</b>	- Temperature ( $T_L$ ) (Liquidus)	217°C
	- Time (min to max) ( $t_s$ )	60 – 150 seconds
<b>Peak Temperature (<math>T_p</math>)</b>		260 <sup>+0/-5</sup> °C
<b>Time within 5°C of actual peak Temperature (<math>t_p</math>)</b>		20 – 40 seconds
<b>Ramp-down Rate</b>		6°C/second max
<b>Time 25°C to peak Temperature (<math>T_p</math>)</b>		8 minutes Max.
<b>Do not exceed</b>		260°C

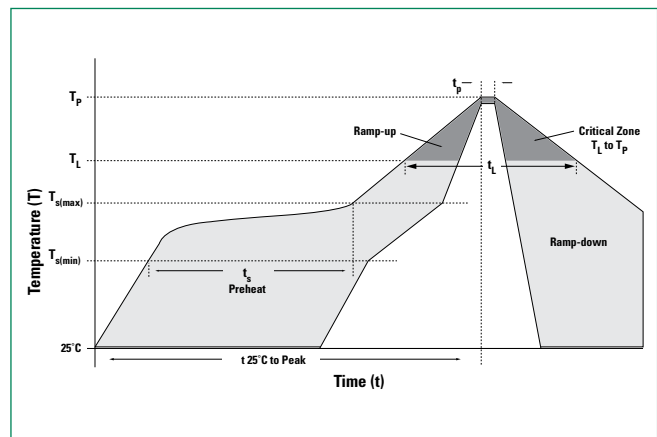

## Physical Specifications

<b>Weight</b>	0.007 ounce, 0.21 grams
<b>Case</b>	JEDEC DO214AB. Molded plastic body over glass passivated junction
<b>Polarity</b>	Color band denotes positive end (cathode) except Bidirectional.
<b>Terminal</b>	Matte Tin-plated leads, Solderable per JESD22-B102

## Environmental Specifications

<b>High Temp. Storage</b>	JESD22-A103
<b>HTRB</b>	JESD22-A108
<b>Thermal Shock</b>	JESD22-A106
<b>MSL</b>	JEDEC-J-STD-020, Level 1
<b>H3TRB</b>	JESD22-A101
<b>RSH</b>	JESD22-A111

# SMDJ-HR Series

## Surface Mount – 3000W

### Part Numbering System

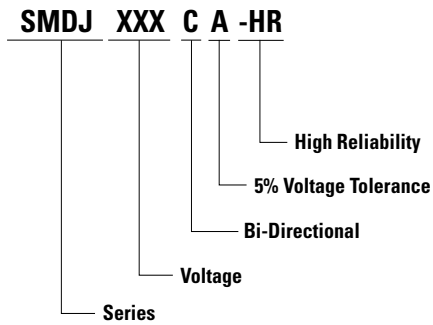

### Part Marking System

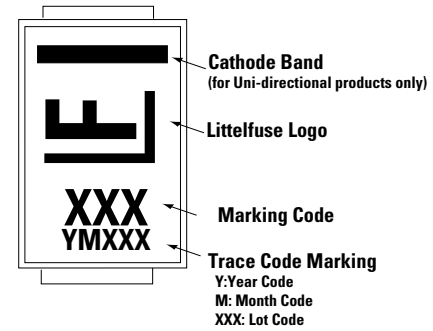

### Packaging

Part number	Component Package	Quantity	Packaging Option	Packaging Specification
SMDJxxxXX-HR	DO-214AB	500	Tape & Reel – 16mm tape/7" reel	EIA STD RS-481

### Dimensions

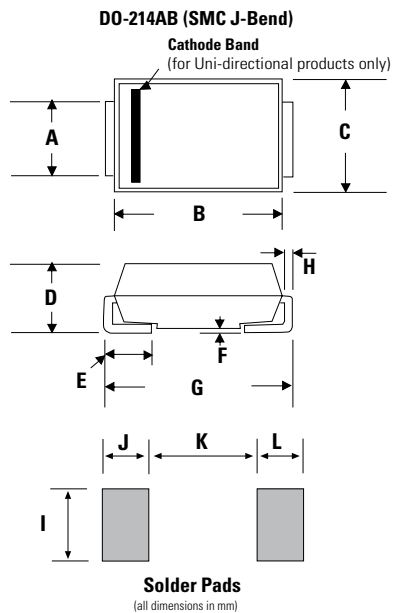

Dimensions	Inches		Millimeters	
	Min	Max	Min	Max
A	0.114	0.126	2.900	3.200
B	0.260	0.280	6.600	7.110
C	0.220	0.245	5.590	6.220
D	0.079	0.103	2.060	2.620
E	0.030	0.060	0.760	1.520
F	0.002	0.008	0.051	0.203
G	0.305	0.320	7.750	8.130
H	0.006	0.012	0.152	0.305
I	0.129	-	3.300	-
J	0.094	-	2.400	-
K	-	0.165	-	4.200
L	0.094	-	2.400	-

# SMDJ-HR Series

## Surface Mount – 3000W

### Tape and Reel Specification

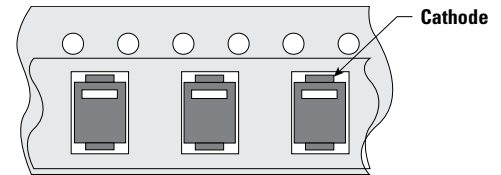
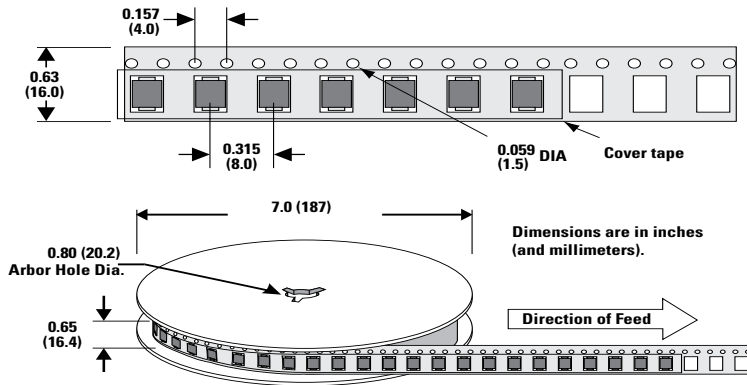

### RTCA/DO-160G Wave 3

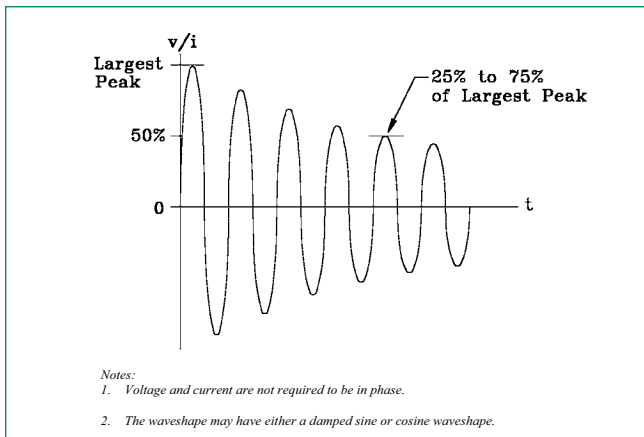

### RTCA/DO-160G Wave 4

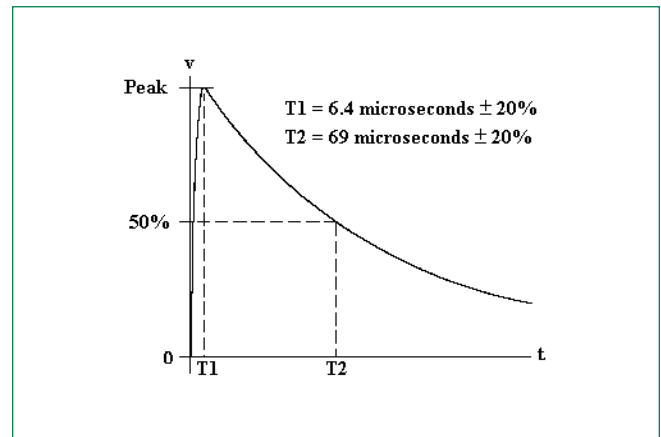

### RTCA/DO-160G Wave 5

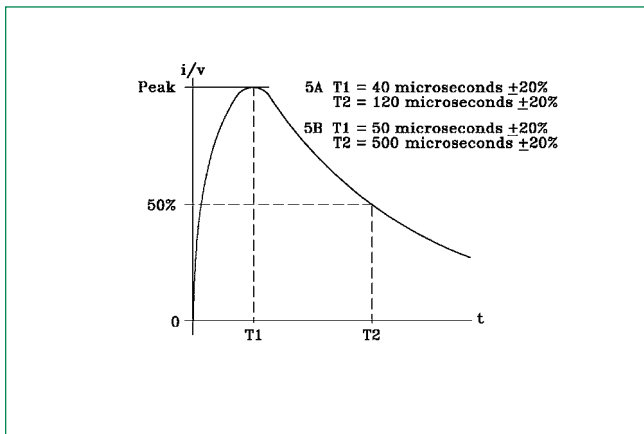

# SMDJ-HR Series

## Surface Mount – 3000W

### Pin Injection Protection Per RTCA/DO-160G

Part Number (Uni)	Part Number (Bi)	25C						70C						120C								
		Wave 3	Wave 4 (6.4/69us)				Wave 5a (40/120us)		Wave 3	Wave 4 (6.4/69us)				Wave 5a (40/120us)		Wave 3	Wave 4 (6.4/69us)				Wave 5a (40/120us)	
			L5	L3	L4	L5	L3	L4		L5	L3	L4	L5	L3	L4		L5	L3	L4	L5	L3	L4
			128A	60A	150A	320A	300A	750A		128A	60A	150A	320A	300A	750A		128A	60A	150A	320A	300A	750A
SMDJ5.0A-HR	SMDJ5.0CA-HR	pass	pass	pass	pass	pass	pass	pass	pass	pass	pass	pass	pass	pass	pass	pass	pass	pass	pass	pass		
SMDJ6.0A-HR	SMDJ6.0CA-HR	pass	pass	pass	pass	pass	pass	pass	pass	pass	pass	pass	pass	pass	pass	pass	pass	pass	pass	pass		
SMDJ6.5A-HR	SMDJ6.5CA-HR	pass	pass	pass	pass	pass	pass	pass	pass	pass	pass	pass	pass	pass	pass	pass	pass	pass	pass	pass		
SMDJ7.0A-HR	SMDJ7.0CA-HR	pass	pass	pass	pass	pass	pass	pass	pass	pass	pass	pass	pass	-	pass	pass	pass	pass	pass	-		
SMDJ7.5A-HR	SMDJ7.5CA-HR	pass	pass	pass	pass	pass	pass	pass	pass	pass	pass	pass	-	pass	pass	pass	pass	pass	pass	-		
SMDJ8.0A-HR	SMDJ8.0CA-HR	pass	pass	pass	pass	pass	pass	pass	pass	pass	pass	pass	-	pass	pass	pass	pass	pass	pass	-		
SMDJ8.5A-HR	SMDJ8.5CA-HR	pass	pass	pass	pass	pass	pass	pass	pass	pass	pass	pass	-	pass	pass	pass	pass	pass	pass	-		
SMDJ9.0A-HR	SMDJ9.0CA-HR	pass	pass	pass	pass	pass	pass	pass	pass	pass	pass	pass	-	pass	pass	pass	pass	pass	pass	-		
SMDJ10A-HR	SMDJ10CA-HR	pass	pass	pass	pass	pass	pass	pass	pass	pass	pass	pass	-	pass	pass	pass	pass	pass	pass	-		
SMDJ11A-HR	SMDJ11CA-HR	pass	pass	pass	pass	pass	-	pass	pass	pass	pass	pass	-	pass	pass	pass	pass	-	-	-		
SMDJ12A-HR	SMDJ12CA-HR	pass	pass	pass	pass	pass	-	pass	pass	pass	pass	pass	-	pass	pass	pass	pass	-	-	-		
SMDJ13A-HR	SMDJ13CA-HR	pass	pass	pass	pass	pass	-	pass	pass	pass	pass	pass	-	pass	pass	pass	pass	-	-	-		
SMDJ14A-HR	SMDJ14CA-HR	pass	pass	pass	pass	pass	-	pass	pass	pass	pass	pass	-	pass	pass	pass	pass	-	-	-		
SMDJ15A-HR	SMDJ15CA-HR	pass	pass	pass	pass	pass	-	pass	pass	pass	pass	pass	-	pass	pass	pass	pass	-	-	-		
SMDJ16A-HR	SMDJ16CA-HR	pass	pass	pass	pass	pass	-	pass	pass	pass	pass	-	-	pass	pass	pass	pass	-	-	-		
SMDJ17A-HR	SMDJ17CA-HR	pass	pass	pass	pass	pass	-	pass	pass	pass	pass	-	-	pass	pass	pass	pass	-	-	-		
SMDJ18A-HR	SMDJ18CA-HR	pass	pass	pass	pass	pass	-	pass	pass	pass	pass	-	-	pass	pass	pass	pass	-	-	-		
SMDJ20A-HR	SMDJ20CA-HR	pass	pass	pass	pass	pass	-	pass	pass	pass	pass	-	-	pass	pass	pass	pass	-	-	-		
SMDJ22A-HR	SMDJ22CA-HR	pass	pass	pass	-	-	-	pass	pass	pass	-	-	-	pass	pass	pass	pass	-	-	-		
SMDJ24A-HR	SMDJ24CA-HR	pass	pass	pass	-	-	-	pass	pass	pass	-	-	-	pass	pass	pass	pass	-	-	-		
SMDJ26A-HR	SMDJ26CA-HR	pass	pass	pass	-	-	-	pass	pass	pass	-	-	-	pass	pass	pass	pass	-	-	-		
SMDJ28A-HR	SMDJ28CA-HR	pass	pass	pass	-	-	-	pass	pass	pass	-	-	-	pass	pass	pass	pass	-	-	-		
SMDJ30A-HR	SMDJ30CA-HR	pass	pass	pass	-	-	-	pass	pass	pass	-	-	-	pass	pass	pass	pass	-	-	-		
SMDJ33A-HR	SMDJ33CA-HR	pass	pass	pass	-	-	-	pass	pass	pass	-	-	-	pass	pass	pass	pass	-	-	-		
SMDJ36A-HR	SMDJ36CA-HR	pass	pass	pass	-	-	-	pass	pass	pass	-	-	-	pass	pass	pass	pass	-	-	-		
SMDJ40A-HR	SMDJ40CA-HR	pass	pass	pass	-	-	-	pass	pass	pass	-	-	-	pass	pass	pass	pass	-	-	-		
SMDJ43A-HR	SMDJ43CA-HR	pass	pass	pass	-	-	-	pass	pass	pass	-	-	-	pass	pass	pass	pass	-	-	-		
SMDJ45A-HR	SMDJ45CA-HR	pass	pass	pass	-	-	-	pass	pass	-	-	-	-	pass	pass	pass	pass	-	-	-		
SMDJ48A-HR	SMDJ48CA-HR	pass	pass	pass	-	-	-	pass	pass	-	-	-	-	pass	pass	pass	pass	-	-	-		
SMDJ51A-HR	SMDJ51CA-HR	pass	pass	pass	-	-	-	pass	pass	-	-	-	-	pass	pass	pass	pass	-	-	-		
SMDJ54A-HR	SMDJ54CA-HR	pass	pass	pass	-	-	-	pass	pass	-	-	-	-	pass	pass	pass	pass	-	-	-		
SMDJ58A-HR	-	pass	pass	-	-	-	-	pass	pass	-	-	-	-	pass	pass	pass	pass	-	-	-		
SMDJ60A-HR	-	pass	pass	-	-	-	-	pass	pass	-	-	-	-	pass	pass	pass	pass	-	-	-		
SMDJ64A-HR	-	pass	pass	-	-	-	-	pass	pass	-	-	-	-	pass	-	-	-	-	-	-		
SMDJ70A-HR	-	pass	pass	-	-	-	-	pass	pass	-	-	-	-	pass	-	-	-	-	-	-		
SMDJ75A-HR	-	pass	pass	-	-	-	-	pass	pass	-	-	-	-	pass	-	-	-	-	-	-		
SMDJ78A-HR	-	pass	pass	-	-	-	-	pass	pass	-	-	-	-	pass	-	-	-	-	-	-		
SMDJ85A-HR	-	pass	pass	-	-	-	-	pass	pass	-	-	-	-	pass	-	-	-	-	-	-		
SMDJ90A-HR	-	pass	pass	-	-	-	-	pass	-	-	-	-	-	pass	-	-	-	-	-	-		
SMDJ100A-HR	-	pass	pass	-	-	-	-	pass	-	-	-	-	-	pass	-	-	-	-	-	-		
SMDJ110A-HR	-	pass	pass	-	-	-	-	pass	-	-	-	-	-	pass	-	-	-	-	-	-		
SMDJ120A-HR	-	pass	pass	-	-	-	-	pass	-	-	-	-	-	pass	-	-	-	-	-	-		
SMDJ130A-HR	-	pass	pass	-	-	-	-	pass	-	-	-	-	-	pass	-	-	-	-	-	-		
SMDJ150A-HR	-	pass	pass	-	-	-	-	pass	-	-	-	-	-	pass	-	-	-	-	-	-		

**Note:**

1. L1 = Level 1, L2 = Level 2, L3 = Level 3, L4 = Level 4, L5 = Level 5

**Disclaimer Notice** - Information furnished is believed to be accurate and reliable. However, users should independently evaluate the suitability of and test each product selected for their own applications. Littelfuse products are not designed for, and may not be used in, all applications. Read complete Disclaimer Notice at <http://www.littelfuse.com/disclaimer-electronics>.



单击下面可查看定价，库存，交付和生命周期等信息

[>>Littelfuse\(美国力特\)](#)