

## ITV9550 45A Series



### Description

ITV9550 Series is a chip type surface mountable device that can protect against both overcurrent and overcharging. It comprises a fuse element to ensure stable operation under normal electrical current and to cut off the current when overcurrent occurs. It also comprises a resistive heating element that could be used in combination with a voltage detecting means, such as IC and FET. When overvoltage is detected, the heating element is electrically excited to generate heat to blow the fuse element to achieve overvoltage protection.

### Agency Approvals

AGENCY	AGENCY FILE NUMBER	AMPERE RANGE
	TBD	45 A
	TBD	45 A

### Features

- Halogen Free
- Surface Mount
- Fast response
- Protection for both overcurrent and overcharging

### Thermal Derating Characteristics

	Ambient Operating Temperature		
	25°C	40°C	60°C
Recommend Rated Current (A)	49.0	44.5	37.0

### Applications

- Self Balancing
- E-Bike
- Power Tool
- Automotive applications
- Energy Storage systems
- Drone

### Electrical Characteristics

Part Number	Ordering Code	I <sub>rated</sub> (A)	Cells in Series	V <sub>max</sub> (Vdc)	I <sub>break</sub> (A)	V <sub>OP</sub> (V)	Resistance		Agency Approvals	
							R <sub>heater</sub> (Ω)	R <sub>fuse</sub> (mΩ)		
ITV9550L1245	ITV9550L1245MR	45	3	62	120	9.8 ~ 13.5	1.9 ~ 3.4	0.4 ~ 2.0	X	X
ITV9550L1445	ITV9550L1445MR	45	4	62	120	13.0 ~ 18.4	3.4 ~ 6.0	0.4 ~ 2.0	X	X
ITV9550L2045	ITV9550L2045MR	45	5	62	120	16.7 ~ 23.5	5.6 ~ 9.9	0.4 ~ 2.0	X	X
ITV9550L3045	ITV9550L3045MR	45	6~7	62	120	22.3 ~ 31.5	10.0 ~ 17.7	0.4 ~ 2.0	X	X
ITV9550L4045	ITV9550L4045MR	45	9~10	62	120	33.0 ~ 46.9	22.0 ~ 38.7	0.4 ~ 2.0	X	X
ITV9550L5045	ITV9550L5045MR	45	12~14	62	120	43.7 ~ 62.0	38.5 ~ 68.0	0.4 ~ 2.0	X	X
Current Capacity		100% x I <sub>rated</sub> No Melting								
Cut Time		200% x I <sub>rated</sub> < 1 min								
Interrupting Current		5 x I <sub>rated</sub> , power on 5 ms, power off 995 ms, 10000 cycles No Melting								
Over Voltage Operation		In operation voltage range, the fusing time is <1min.								

#### Notes:

I<sub>rated</sub> = Current carrying capacity that is measured at 40°C thermal equilibrium condition

I<sub>break</sub> = The current that the fuse element is able to interrupt

V<sub>max</sub> = The maximum voltage that can be cut off by fuse

R<sub>heater</sub> = The resistance of the heating element

R<sub>fuse</sub> = The resistance of the fuse element

Cells in series = Number of battery cells connected in series in the circuit for ITV device to protect.

• Value specified is determined by using the PWB with 29.4mm\*2oz copper traces, AWG18 covered wire, and 0.6mm glass epoxy PCB.

• Specifications are subject to change without notice.

**Cut Time by Heater Operation**

Various heater wattage at 25°C ambient temperature

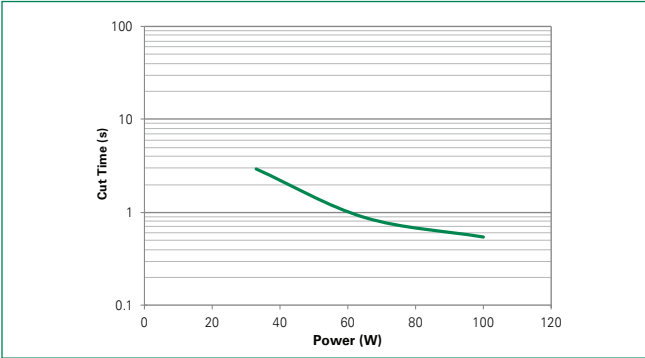

Constant heater wattage at various ambient temperature

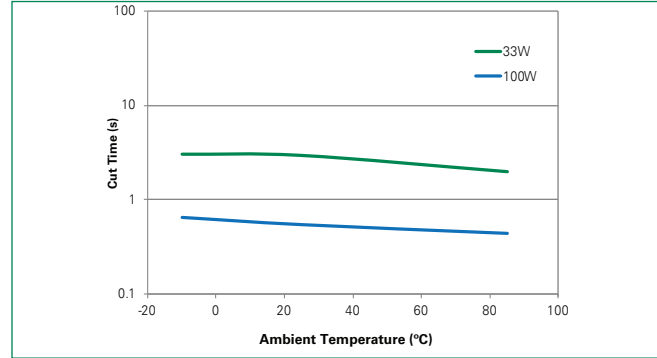

**Cut Time by Current Operation**

Various interrupting current at 25°C ambient temperature

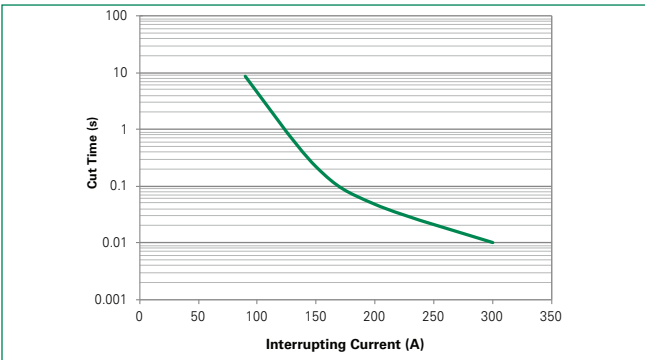

Constant 2x rated current at various ambient temperature

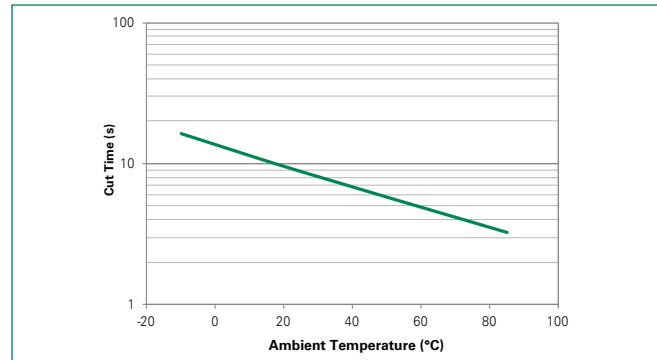

**Environmental Specifications**

<b>Storage Temperature</b>	0~35°C, ≤70%RH 3 months after shipment
<b>Operating Temperature</b>	-10°C to +65°C
<b>Operating Electric Power</b>	-25°C to +85°C/6~35W (applied to heater)
<b>Hot Passive Aging</b>	100±5°C, 250 hours No structural damage and functional failure
<b>Humidity Aging</b>	60°C±2°C, 90~95% R.H. 250 hours No structural damage and functional failure
<b>Cold Passive Aging</b>	-20±3°C, 500 hours No structural damage and functional failure
<b>Thermal Shock</b>	MIL-STD-202 Method 107G +125°C/-55°C, 100 times No structural damage and functional failure
<b>Solvent Resistance</b>	MIL-STD-202, Method 215
<b>Vibration</b>	MIL-STD-883C, Method 2007.1, Condition A No structural damage and functional failure
<b>Moisture Level Sensitivity</b>	Level 1, J-STD-020C

**Physical Dimension (mm)**

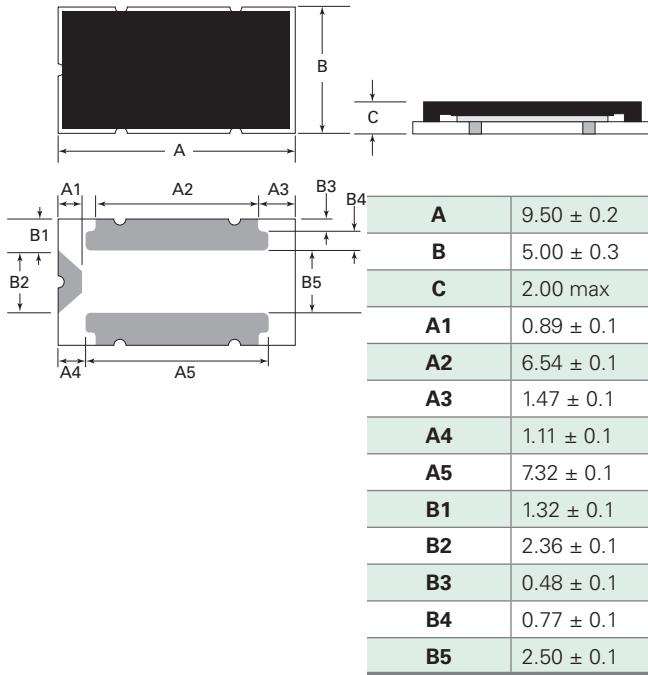

**Device Circuit**

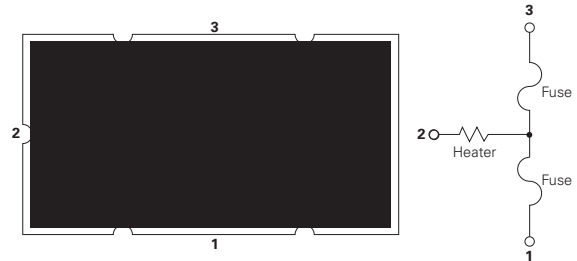

**Board and Solder Layout Recommend (mm)**

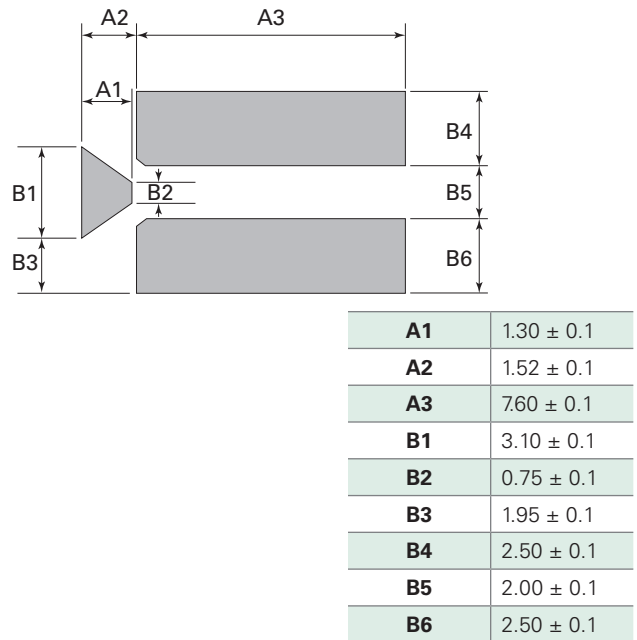

**Physical Specifications**

<b>Material</b>	Glass Epoxy PCB
<b>Base Thickness</b>	0.6mm
<b>Copper Thickness</b>	0.07mm
<b>Covered Wire</b>	AWG8

**Soldering Parameters**

<b>Average Ramp-Up Rate (Ts<sub>max</sub> to TP)</b>	3°C/second max.	
<b>Preheat</b>	<b>Temperature Min (Ts<sub>min</sub>)</b>	150°C
	<b>Temperature Max (Ts<sub>max</sub>)</b>	200°C
	<b>Time (Ts<sub>min</sub> to Ts<sub>max</sub>)</b>	60-120 seconds
<b>Time maintained above:</b>	<b>Temperature (TL)</b>	217°C
	<b>Time (tL)</b>	60-105 seconds
<b>Peak Temperature (TP)</b>	255°C	
<b>Time within 5°C of actual Peak Temperature (tp)</b>	5 seconds max.	
<b>Ramp-Down Rate</b>	6°C/second max.	
<b>Time 25°C to Peak Temperature</b>	8 minutes max.	

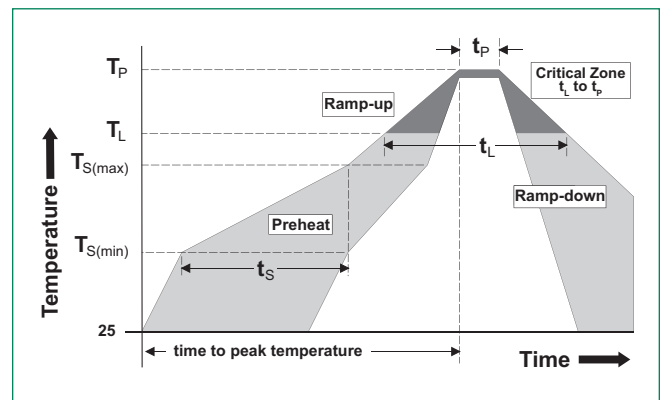

- All temperature refer to topside of the package, measured on the package body surface
- If reflow temperature exceeds the recommended profile, devices may not meet the performance requirements
- Recommended reflow methods: IR, vapor phase oven, hot air oven, N<sub>2</sub> environment for lead
- Recommended maximum paste thickness is 0.25mm (0.010inch)
- Devices can be cleaned using standard industry methods and solvents
- Devices can be reworked using the standard industry practices

**Part Numbering System**

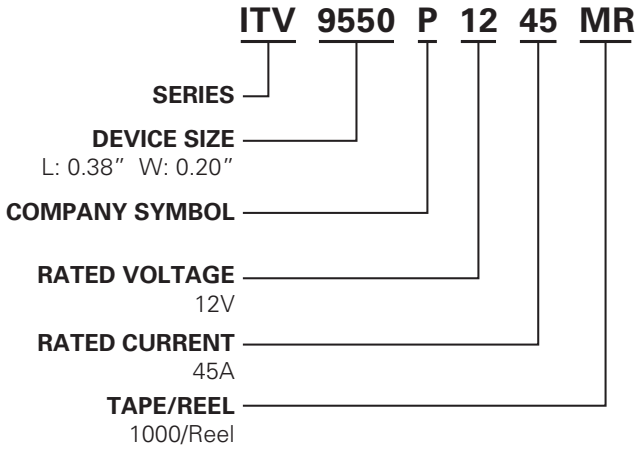

**Part Marking System**

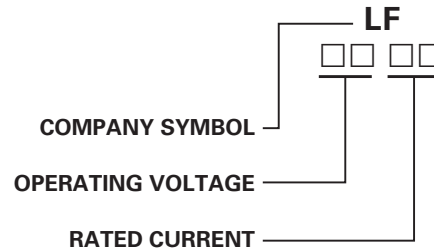

**Packaging**

Part Number	Tape and Reel Quantity
ITV9550LXX45	1,000

**Installation and Handling Guidelines**

- Before and after mounted, the ultrasonic-cleaning or immersion-cleaning must not be done to ITV device. The flux on element would flow, and it would not be satisfied its specification when cleaning is done. In addition, a similar influence happens when the product comes in contact with cleaning solution. These products after cleaning will not be guaranteed.
- Silicone-based oils, oils, solvents, gels, electrolytes, fuels, acids, and similar will adversely affect the properties of ITV devices, and shall not be used or applied.
- Please DO NOT reuse the ITV device removed by the soldering process.
- ITV devices are secondary protection devices and are used solely for sporadic, accidental overcurrent or overtemperature error condition, and shall NOT be used if or when constant or repeated fault conditions (such fault conditions may be caused by, among others, incorrect pin-connection of a connector) or over-extensive trip events may occur.
- Operation over the maximum rating or other forms of improper use may cause failure, arcing, flame and/or other damage to the ITV devices.
- The performance of ITV devices will be adversely affected if they are improperly used under electronic, thermal and/or mechanical procedures and/or conditions non-conformant to those recommended by manufacturer.
- Customers shall be responsible for determining whether it is necessary to have back-up, failsafe and/or fool-proof protection to avoid or minimize damage that may result from extra-ordinary, irregular function or failure of ITV devices.
- There should be minimum of 0.1mm spacing between ITV and surrounding compounds, to maintain the product characteristics and avoid damage other surrounding compounds.
- This product is designed and manufactured only for general-use of electronics devices. We do not recommend that it is used for the applications military, medical and so on which may cause direct damages on life, bodies or properties.

**Tape and Reel Specifications (mm)**

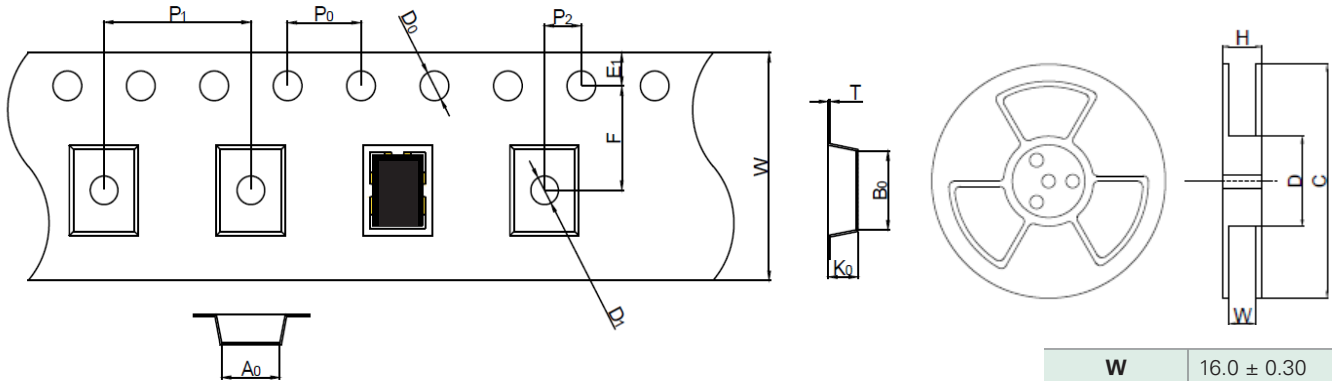

<b>W</b>	16.0 ± 0.30
<b>F</b>	7.50 ± 0.05
<b>E1</b>	1.75 ± 0.10
<b>D0</b>	1.50 ± 0.05
<b>D1</b>	1.50 ± 0.10
<b>P0</b>	4.00 ± 0.10
<b>P1</b>	8.00 ± 0.10
<b>P2</b>	2.00 ± 0.10
<b>A0</b>	5.40 ± 0.10
<b>B0</b>	9.90 ± 0.10
<b>T</b>	0.30 ± 0.05
<b>K0</b>	2.48 ± 0.10
<b>H</b>	22.4 ± 0.1
<b>W</b>	16.4 ± 1.5
<b>D</b>	Ø100 ± 0.5
<b>C</b>	Ø330 ± 1.0

Disclaimer Notice - Information furnished is believed to be accurate and reliable. However, users should independently evaluate the suitability of and test each product selected for their own applications. Littelfuse products are not designed for, and may not be used in, all applications. Read complete Disclaimer Notice at [www.littelfuse.com/disclaimer-electronics](http://www.littelfuse.com/disclaimer-electronics).

单击下面可查看定价，库存，交付和生命周期等信息

[>>Littelfuse\(美国力特\)](#)