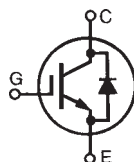

**High Voltage, High Gain
BIMOSFET™ Monolithic
Bipolar MOS Transistor**
**IXBT42N170A
IXBH42N170A**

$$V_{CES} = 1700V$$

$$I_{C90} = 21A$$

$$V_{CE(sat)} \leq 6.0V$$

$$t_{fi} = 20ns$$

Symbol	Test Conditions	Maximum Ratings	
V_{CES}	$T_C = 25^\circ C$ to $150^\circ C$	1700	V
V_{CGR}	$T_J = 25^\circ C$ to $150^\circ C$, $R_{GE} = 1M\Omega$	1700	V
V_{GES}	Continuous	± 20	V
V_{GEM}	Transient	± 30	V
I_{C25}	$T_C = 25^\circ C$	42	A
I_{C90}	$T_C = 90^\circ C$	21	A
I_{CM}	$T_C = 25^\circ C$, 1ms	265	A
SSOA (RBSOA)	$V_{GE} = 15V$, $T_{VJ} = 125^\circ C$, $R_G = 10\Omega$ Clamped Inductive Load	$I_{CM} = 84$ 1360	A V
T_{SC} (SCSOA)	$V_{GE} = 15V$, $V_{CES} = 1200V$, $T_J = 125^\circ C$ $R_G = 10\Omega$, non repetitive	10	μs
P_C	$T_C = 25^\circ C$	357	W
T_J		-55 ... +150	$^\circ C$
T_{JM}		150	$^\circ C$
T_{stg}		-55 ... +150	$^\circ C$
T_L	1.6mm (0.062 in.) from Case for 10s	300	$^\circ C$
T_{SOLD}	Plastic Body for 10 seconds	260	$^\circ C$
M_d	Mounting Torque (TO-247)	1.13/10	Nm/lb.in.
Weight	TO-268	4	g
	TO-247	6	g

TO-268 (IXBT)

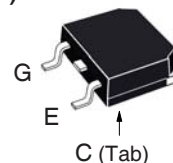

TO-247 (IXBH)

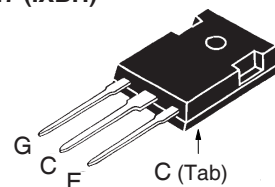

G = Gate C = Collector
E = Emitter Tab = Collector

Features

- High Blocking Voltage
- International Standard Packages
- Anti-Parallel Diode
- Low Conduction Losses

Advantages

- Low Gate Drive Requirement
- High Power Density

Applications

- Switch-Mode and Resonant-Mode Power Supplies
- Uninterruptible Power Supplies (UPS)
- AC Motor Drives
- Capacitor Discharge Circuits
- AC Switches

Symbol	Test Conditions ($T_J = 25^\circ C$ Unless Otherwise Specified)	Characteristic Values		
		Min.	Typ.	Max.
BV_{CES}	$I_C = 250\mu A$, $V_{GE} = 0V$	1700		V
$V_{GE(th)}$	$I_C = 750\mu A$, $V_{CE} = V_{GE}$	2.5		V
I_{CES}	$V_{CE} = 0.8 \cdot V_{CES}$, $V_{GE} = 0V$ $T_J = 125^\circ C$			50 μA 1.5 mA
I_{GES}	$V_{CE} = 0V$, $V_{GE} = \pm 20V$			± 100 nA
$V_{CE(sat)}$	$I_C = I_{C90}$, $V_{GE} = 15V$, Note 1 $T_J = 125^\circ C$		5.2	6.0 V
			5.3	V

Symbol	Test Conditions ($T_J = 25^\circ\text{C}$ Unless Otherwise Specified)	Characteristic Values		
		Min.	Typ.	Max.
g_{fs}	$I_C = I_{C90}, V_{CE} = 10\text{V}$, Note 1	14	23	S
C_{ies}	$V_{CE} = 25\text{V}, V_{GE} = 0\text{V}, f = 1\text{MHz}$		3920	pF
C_{oes}			275	pF
C_{res}			107	pF
$Q_{g(on)}$	$I_C = I_{C90}, V_{GE} = 15\text{V}, V_{CE} = 0.5 \cdot V_{CES}$		188	nC
Q_{ge}			23	nC
Q_{gc}			80	nC
$t_{d(on)}$	Inductive load, $T_J = 25^\circ\text{C}$ $I_C = I_{C90}, V_{GE} = 15\text{V}$ $V_{CE} = 0.5 \cdot V_{CES}, R_G = 1\Omega$ Diode Type = DH40-18A Note 2		19	ns
t_{ri}			17	ns
E_{on}			3.43	mJ
$t_{d(off)}$			200	ns
t_{fi}			20	ns
E_{off}			0.43	mJ
$t_{d(on)}$	Inductive load, $T_J = 125^\circ\text{C}$ $I_C = I_{C90}, V_{GE} = 15\text{V}$ $V_{CE} = 0.5 \cdot V_{CES}, R_G = 1\Omega$ Diode Type = DH40-18A Note 2		19	ns
t_{ri}			14	ns
E_{on}			5.40	mJ
$t_{d(off)}$			226	ns
t_{fi}			82	ns
E_{off}			0.83	mJ
R_{thJC}	TO-247			0.35 $^\circ\text{C/W}$
R_{thCS}			0.21	$^\circ\text{C/W}$

Reverse Diode

Symbol	Test Conditions ($T_J = 25^\circ\text{C}$ Unless Otherwise Specified)	Characteristic Values		
		Min.	Typ.	Max.
V_F	$I_F = I_{C90}, V_{GE} = 0\text{V}$			5.0 V
t_{rr}	$I_F = 25\text{A}, V_{GE} = 0\text{V}, -di_F/dt = 50\text{A}/\mu\text{s}$		330	ns
I_{RM}		$V_R = 100\text{V}, V_{GE} = 0\text{V}$	15	

Note 1: Pulse test, $t \leq 300\mu\text{s}$, duty cycle, $d \leq 2\%$.

PRELIMINARY TECHNICAL INFORMATION

The product presented herein is under development. The Technical Specifications offered are derived from data gathered during objective characterizations of preliminary engineering lots; but also may yet contain some information supplied during a pre-production design evaluation. IXYS reserves the right to change limits, test conditions, and dimensions without notice.

TO-268 Outline

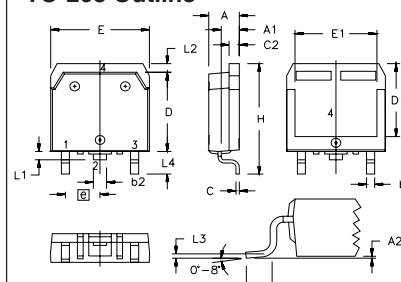

Terminals: 1 - Gate, 2,4 - Collector, 3 - Emitter

SYM	INCHES		MILLIMETERS	
	MIN	MAX	MIN	MAX
A	.193	.201	4.90	5.10
A1	.106	.114	2.70	2.90
A2	.001	.010	0.02	0.25
b	.045	.057	1.15	1.45
b2	.075	.083	1.90	2.10
C	.016	.026	0.40	0.65
C2	.057	.063	1.45	1.60
D	.543	.551	13.80	14.00
D1	.488	.500	12.40	12.70
E	.624	.632	15.85	16.05
E1	.524	.535	13.30	13.60
e	.215 BSC		5.45 BSC	
H	.736	.752	18.70	19.10
L	.094	.106	2.40	2.70
L1	.047	.055	1.20	1.40
L2	.039	.045	1.00	1.15
L3	.010 BSC		0.25 BSC	
L4	.150	.161	3.80	4.10

TO-247 Outline

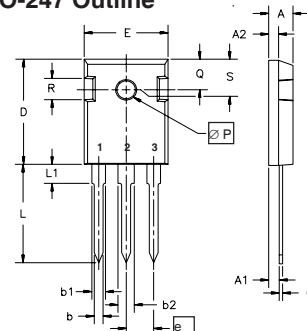

Terminals: 1 - Gate, 2 - Collector, 3 - Emitter

Dim.	Millimeter		Inches	
	Min.	Max.	Min.	Max.
A	4.7	5.3	.185	.209
A ₁	2.2	2.54	.087	.102
A ₂	2.2	2.6	.059	.098
b	1.0	1.4	.040	.055
b ₁	1.65	2.13	.065	.084
b ₂	2.87	3.12	.113	.123
C	.4	.8	.016	.031
D	20.80	21.46	.819	.845
E	15.75	16.26	.610	.640
e	5.20	5.72	0.205	0.225
L	19.81	20.32	.780	.800
L1		4.50		.177
∅P	3.55	3.65	.140	.144
Q	5.89	6.40	0.232	0.252
R	4.32	5.49	.170	.216
S	6.15	BSC	242	BSC

IXYS Reserves the Right to Change Limits, Test Conditions and Dimensions.

IXYS MOSFETs and IGBTs are covered 4,835,592 4,931,844 5,049,961 5,237,481 6,162,665 6,404,065 B1 6,683,344 6,727,585 7,005,734 B2 7,157,338B2
by one or more of the following U.S. patents: 4,860,072 5,017,508 5,063,307 5,381,025 6,259,123 B1 6,534,343 6,710,405 B2 6,759,692 7,063,975 B2
4,881,106 5,034,796 5,187,117 5,486,715 6,306,728 B1 6,583,505 6,710,463 6,771,478 B2 7,071,537

Fig. 1. Output Characteristics @ $T_J = 25^\circ\text{C}$

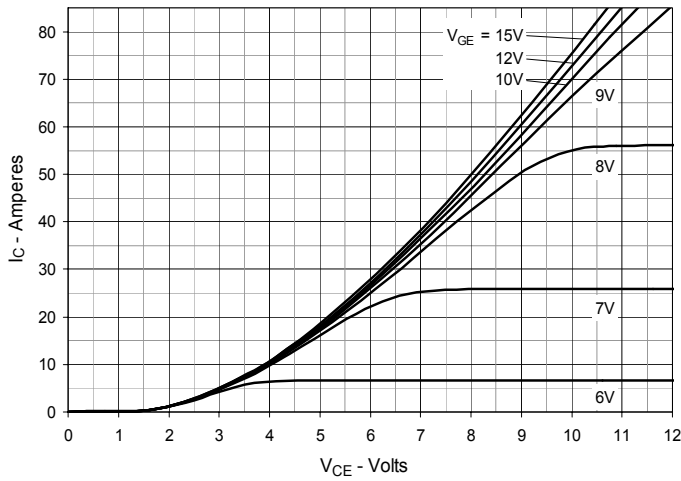

Fig. 2. Extended Output Characteristics @ $T_J = 25^\circ\text{C}$

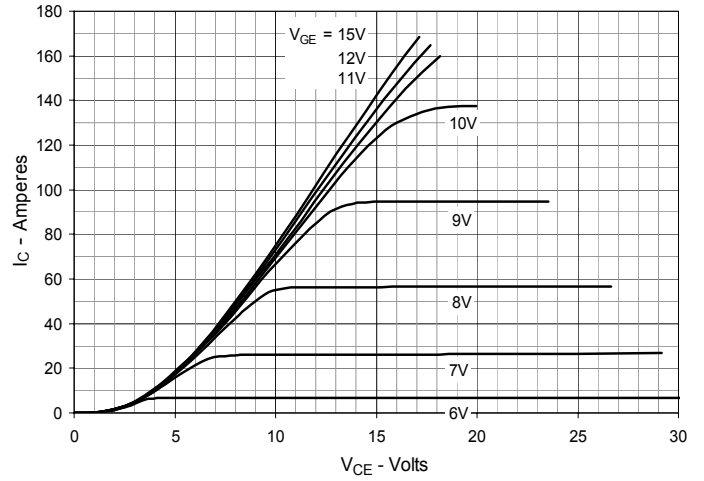

Fig. 3. Output Characteristics @ $T_J = 125^\circ\text{C}$

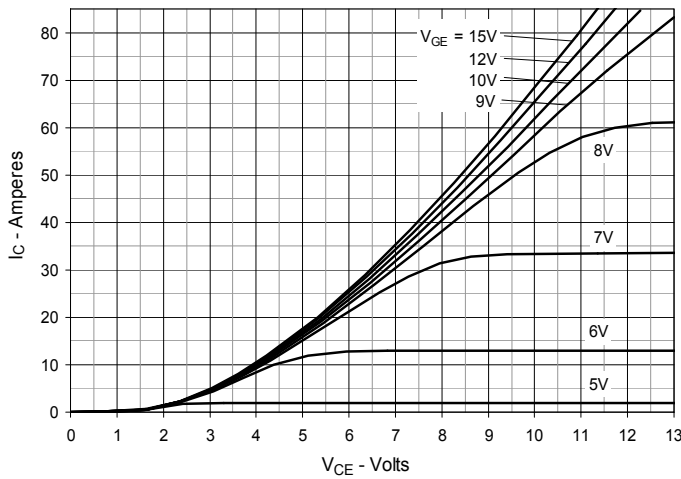

Fig. 4. Dependence of $V_{CE(sat)}$ on Junction Temperature

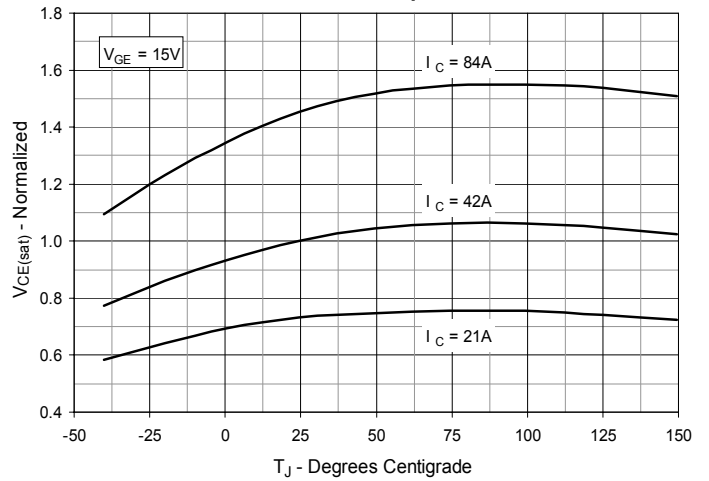

Fig. 5. Collector-to-Emitter Voltage vs. Gate-to-Emitter Voltage

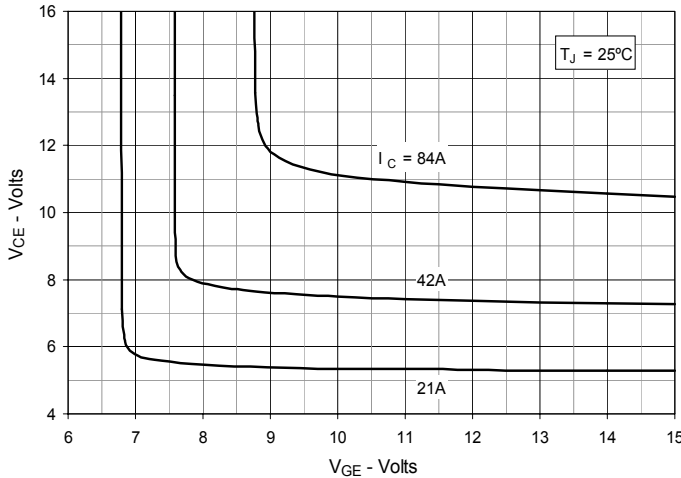

Fig. 6. Input Admittance

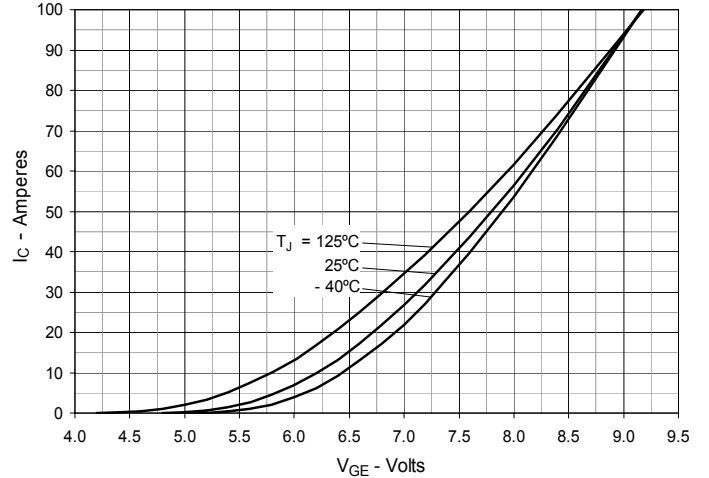

Fig. 7. Transconductance

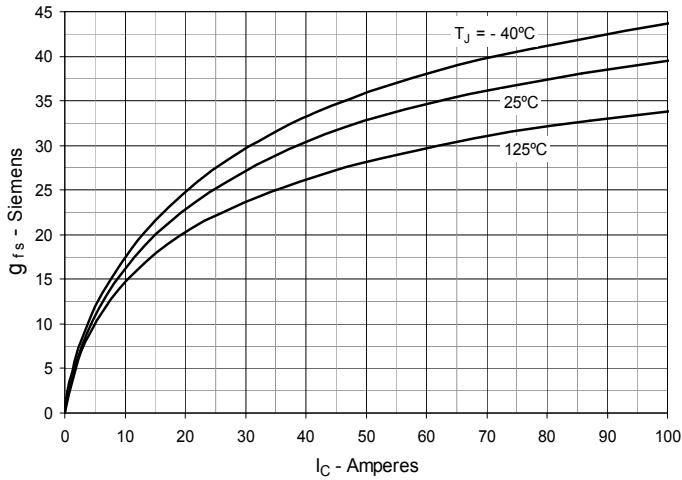

Fig. 8. Gate Charge

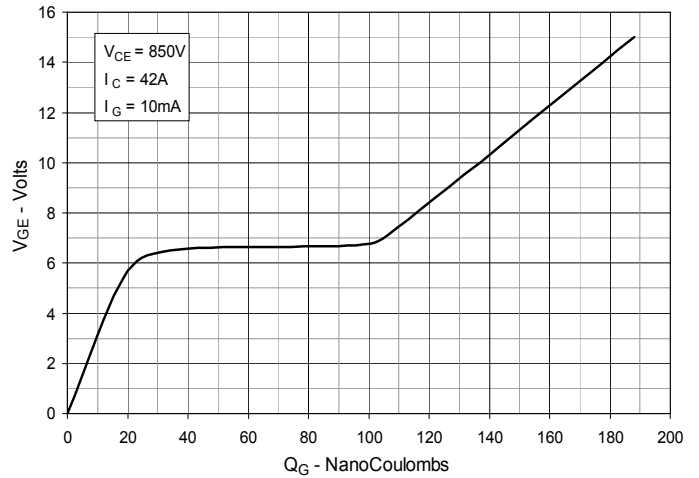

Fig. 9. Forward Voltage Drop of Intrinsic Diode

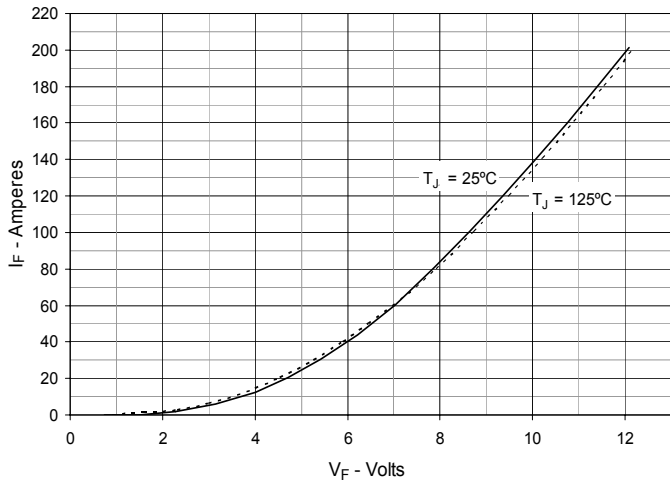

Fig. 10. Capacitance

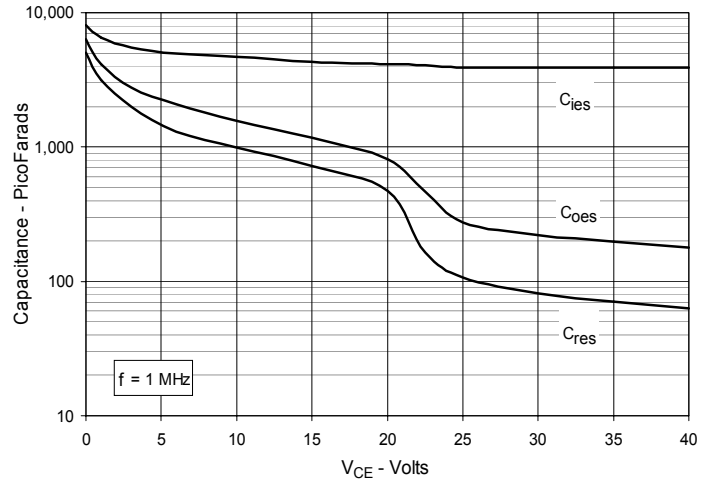

Fig. 11. Reverse-Bias Safe Operating Area

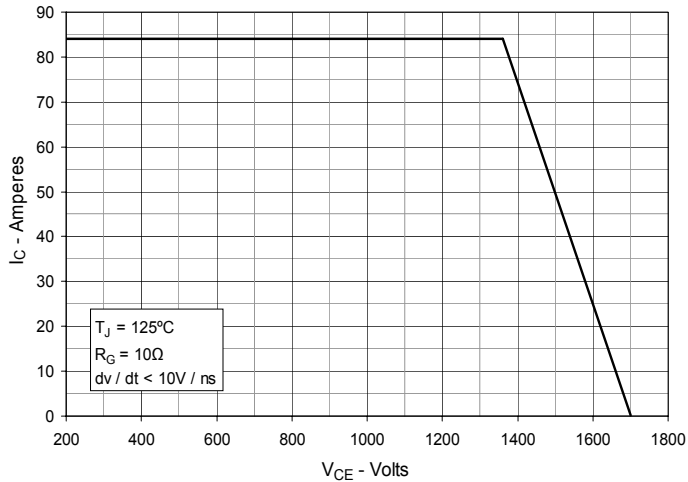

Fig. 12. Maximum Transient Thermal Impedance

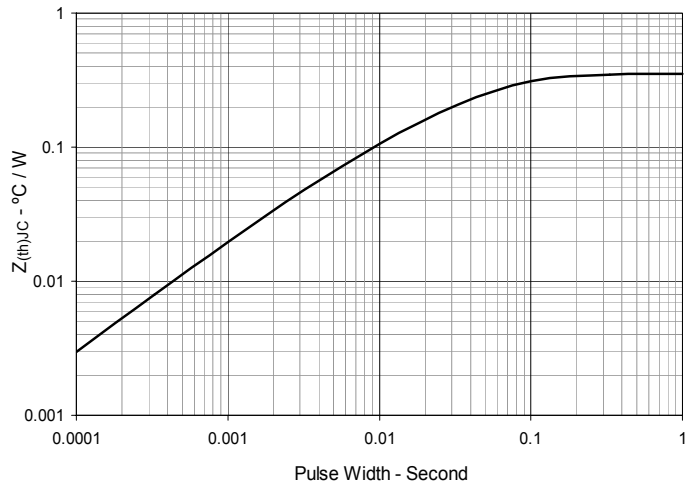

Fig. 13. Forward-Bias Safe Operating Area @ $T_C = 25^\circ\text{C}$

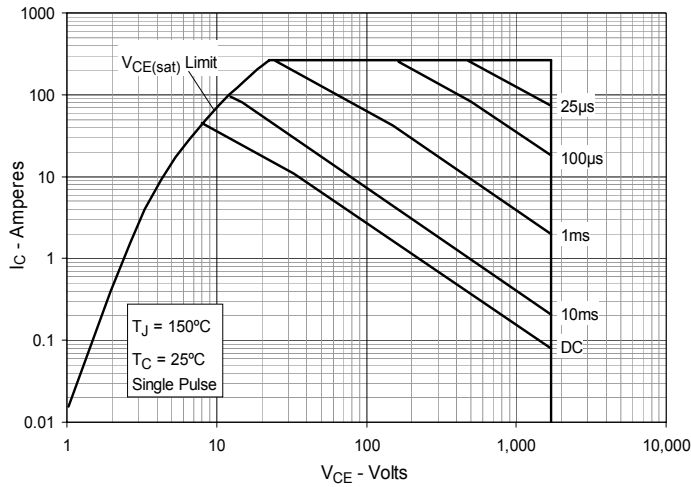

Fig. 14. Forward-Bias Safe Operating Area @ $T_C = 75^\circ\text{C}$

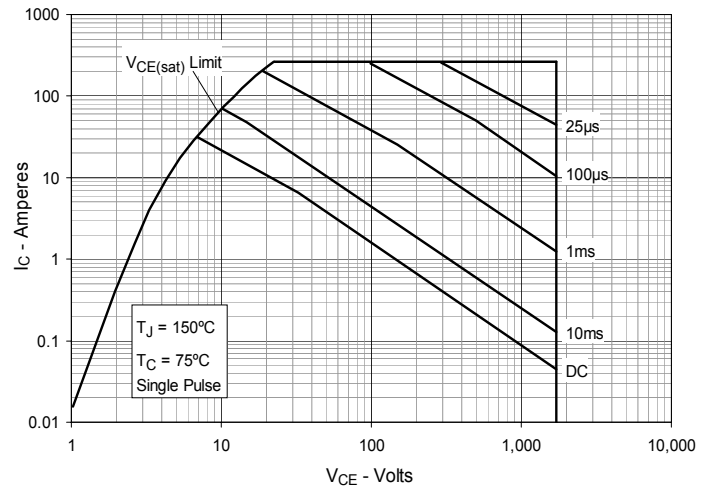

Fig. 15. Inductive Switching Energy Loss vs. Gate Resistance

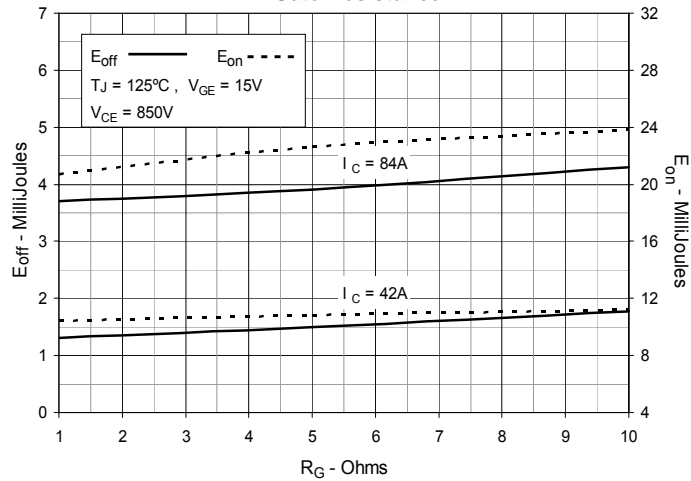

Fig. 16. Inductive Switching Energy Loss vs. Collector Current

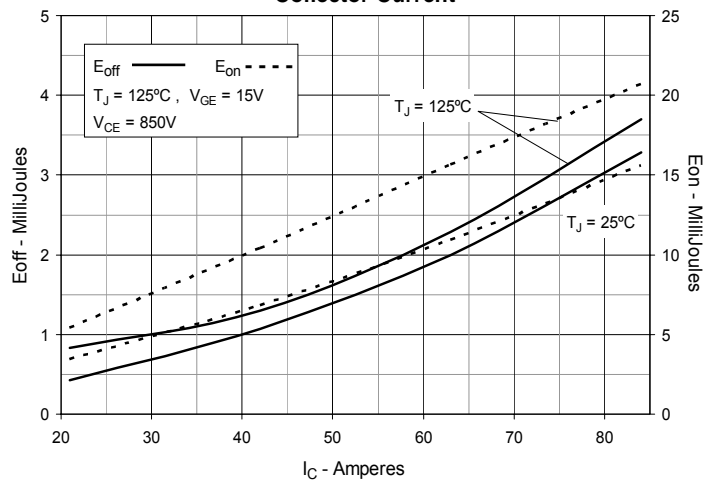

Fig. 17. Inductive Switching Energy Loss vs. Junction Temperature

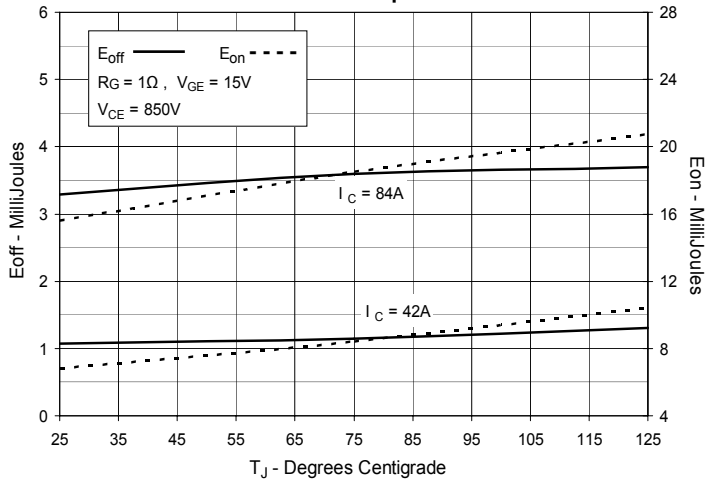

Fig. 18. Inductive Turn-off Switching Times vs. Gate Resistance

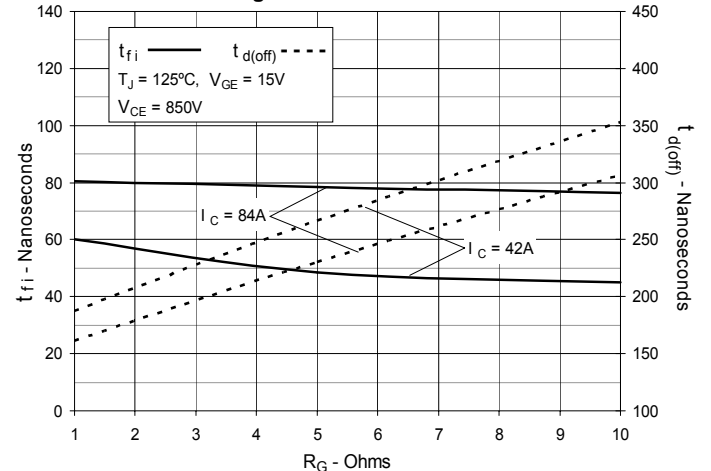

Fig. 19. Inductive Turn-off Switching Times vs. Collector Current

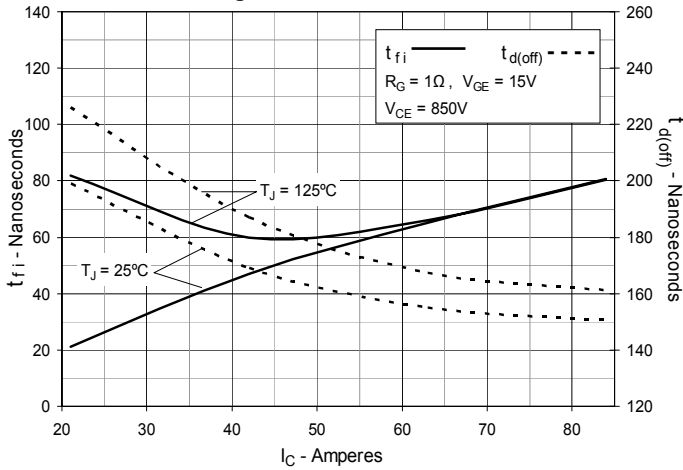

Fig. 20. Inductive Turn-off Switching Times vs. Junction Temperature

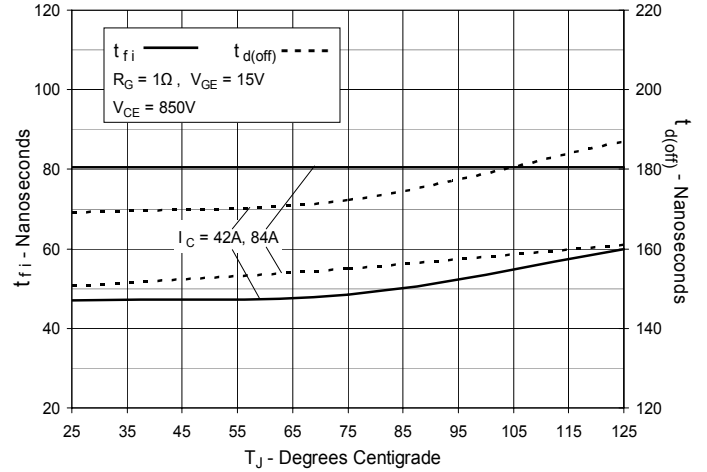

Fig. 21. Inductive Turn-on Switching Times vs. Gate Resistance

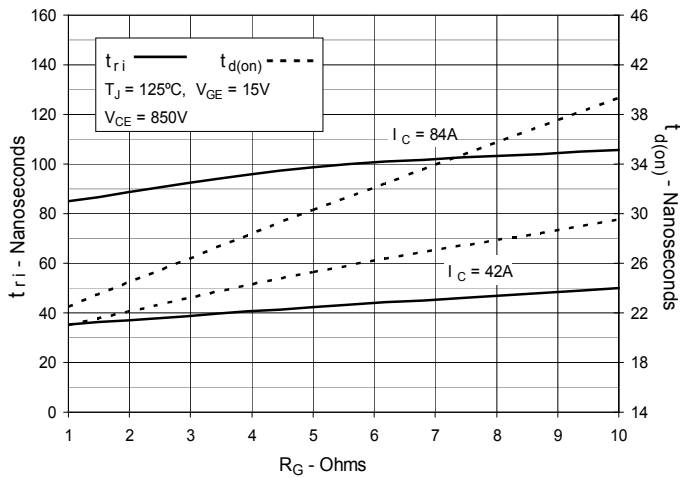

Fig. 22. Inductive Turn-on Switching Times vs. Collector Current

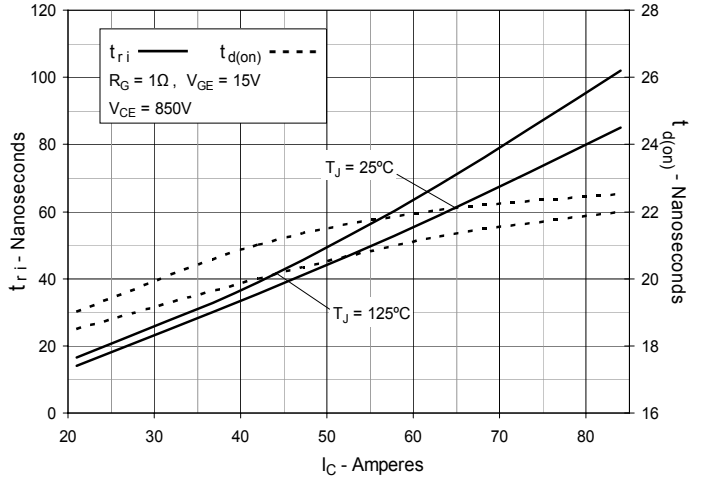
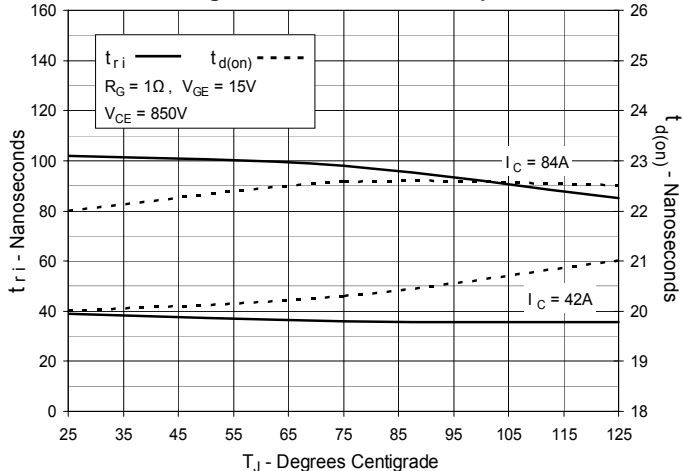

Fig. 23. Inductive Turn-on Switching Times vs. Junction Temperature





Disclaimer Notice - Information furnished is believed to be accurate and reliable. However, users should independently evaluate the suitability of and test each product selected for their own applications. Littelfuse products are not designed for, and may not be used in, all applications. Read complete Disclaimer Notice at www.littelfuse.com/disclaimer-electronics.

单击下面可查看定价，库存，交付和生命周期等信息

[>>Littelfuse\(美国力特\)](#)